



Scan to see the online manual.



OWNER'S MANUAL

DRYER

Read this owner's manual thoroughly before operating the appliance and keep it handy for reference at all times.

ENGLISH

DL*X450**



MFL70442671
Rev.00_022824

www.lg.com

Copyright © 2024 LG Electronics Inc. All Rights Reserved.

TABLE OF CONTENTS

3 IMPORTANT SAFETY INSTRUCTIONS

- 3 READ ALL INSTRUCTIONS BEFORE USE
- 4 WARNING STATEMENTS

8 PRODUCT OVERVIEW

- 8 Product Features

11 INSTALLATION

- 11 Before Installing
- 12 Choosing the Proper Location
- 16 Leveling the Appliance
- 16 Reversing the Door
- 18 Installing the Vent Kit
- 19 Stacking the Appliance
- 20 Venting the Dryer
- 21 Connecting Gas Dryers
- 23 Connecting Electric Dryers
- 26 Connecting the Water Inlet Hose
- 28 Final Installation Check

31 OPERATION

- 31 Before Use
- 32 Loading the Dryer
- 34 Control Panel
- 36 Dry Cycles
- 40 Cycle Modifiers
- 41 Options and Extra Functions

43 SMART FUNCTIONS

- 43 LG ThinQ Application
- 45 Smart Diagnosis™ Function

47 MAINTENANCE

- 47 Regular Cleaning

49 TROUBLESHOOTING

- 49 FAQs
- 50 Before Calling for Service

56 LIMITED WARRANTY

- 56 USA

IMPORTANT SAFETY INSTRUCTIONS

READ ALL INSTRUCTIONS BEFORE USE

Safety for a Dryer



WARNING

Fire Hazard

Failure to follow safety warnings exactly could result in serious injury, death or property damage.

- Do not install a booster fan in the exhaust duct.
- Install all clothes dryers in accordance with the installation instructions of the manufacturer of the dryer.



WARNING:

FIRE OR EXPLOSION HAZARD

Failure to follow safety warnings exactly could result in serious injury, death or property damage.

- Do not store or use gasoline or other flammable vapors and liquids in the vicinity of this or any other appliance.
- **WHAT TO DO IF YOU SMELL GAS**
 - Do not try to light any appliance.
 - Do not touch any electrical switch; do not use any phone in your building.
 - Clear the room, building or area of all occupants.
 - Immediately call your gas supplier from a neighbor's phone. Follow the gas supplier's instructions.
 - If you cannot reach your gas supplier, call the fire department.
- Installation and service must be performed by a qualified installer, service agency or your gas supplier.



WARNING

Risk of Fire

Install the clothes dryer according to the manufacturer's instructions and local codes.

- **Clothes dryer installation must be performed by a qualified installer.**
- **Do not install a clothes dryer with flexible plastic venting materials. If flexible metal (foil type) duct is installed, it must be of a specific type identified by the appliance manufacturer as suitable for use with clothes dryers. Flexible venting materials are known to collapse, be easily crushed, and trap lint. These conditions will obstruct clothes dryer airflow and increase the risk of fire.**
- **To reduce the risk of severe injury or death, follow all installation instructions.**

Safety Messages

Your safety and the safety of others are very important.

We have provided many important safety messages in this manual and on your appliance. Always read and follow all safety messages.



This is the safety alert symbol.

This symbol alerts you to potential hazards that can kill or injure you and others. All safety messages will follow the safety alert symbol and either the word WARNING or CAUTION.



WARNING

You may be killed or seriously injured if you do not follow instructions.



CAUTION

You may be injured or cause damage to the product if you do not follow instructions.

All safety messages will tell you what the potential hazard is, tell you how to reduce the chance of injury, and tell you what may happen if the instructions are not followed.

WARNING STATEMENTS



WARNING

- To reduce the risk of explosion, fire, death, electric shock, scalding or injury to persons when using this product, follow basic precautions, including the following:

Installation

- Adhere to all industry recommended safety procedures including the use of long-sleeved gloves and safety glasses.
- Before use, the appliance must be properly installed as described in this manual.
- Connect to a properly rated, protected, and sized power circuit to avoid electrical overload.

- The appliance must be installed and electrically grounded by qualified service personnel in accordance with local codes.
- Disconnect the power cord, house fuse or circuit breaker before installing or servicing the appliance.
- When moving or installing the appliance in a different location, call qualified service personnel for installation and service.
- Keep packing materials out of the reach of children. Packaging material can be dangerous for children. There is a risk of suffocation.
- Moving or installation of the appliance requires two or more people.
- This appliance is not designed for maritime use or for mobile installations such as in RVs, trailers, or aircraft.
- This appliance must be positioned near to an electrical power supply.
- Do not, under any circumstances, cut or remove the third (ground) prong from the power cord.
- When installing or moving the appliance, be careful not to pinch, crush, or damage the power cord.
- Do not install the appliance in humid spaces.
- Destroy the carton, plastic bag, and other packing materials after the appliance is unpacked. Children might use them for play. Cartons covered with rugs, bedspreads, or plastic sheets can become airtight chambers.
- Place the appliance at least 18 inches above the floor for a garage installation.
- Do not use sheet metal screws or other fasteners which extend into the duct that could catch lint and reduce the efficiency of the exhaust system. Secure all joints with duct tape.
- Use only rigid, semi-rigid or flexible metal 4-inch diameter duct inside the dryer cabinet or for exhausting to the outside. Use of plastic or other combustible ductwork may cause a fire. Punctured ductwork may cause a fire if it collapses or becomes otherwise restricted in use or during installation.
- The exhaust duct must be 4 inches (10.2 cm) in diameter with no obstructions. The exhaust duct should be kept as short as possible. Make sure to clean any old ducts before installing your new dryer.
- Rigid, semi-rigid or flexible metal ducting is recommended for use between the dryer and the wall. All non-rigid metal transition duct must be UL-listed. Use of other materials for the transition duct could affect the drying time.
- Ductwork is not provided with the dryer, and you should obtain the necessary ductwork locally. The end cap should have hinged dampers to prevent backdraft when the dryer is not in use.
- Gas dryers MUST be exhausted to the outside.
- The dryer exhaust system must be exhausted to the outside of the dwelling. If the dryer is not exhausted outdoors, some fine lint and large amounts of moisture will be expelled into the laundry area. An accumulation of lint in any area of the home may create a health and fire hazard.
- Do not install near another heat source such as a stove, oven or heater.
- Keep the area around the exhaust opening and adjacent surrounding areas free from the accumulation of lint, dust, and dirt.
- The appliance must not be supplied through an external switching device, such as a timer, or connected to a circuit that is regularly switched on and off by a utility.
- Certain internal parts are intentionally not grounded and may present a risk of electronic shock only during servicing. Service personnel - do not contact the following parts while the appliance is energized:
CONTROL BOARD

Operation

- Never attempt to operate this appliance if it is damaged, malfunctioning, partially disassembled, or has missing or broken parts, including a damaged cord or plug.
- Repair or immediately replace all power cords that have become frayed or otherwise damaged. Do not use a cord that shows cracks or abrasion damage along its length or at either end.

6 IMPORTANT SAFETY INSTRUCTIONS

- If you detect a strange sound, a chemical or burning smell, or smoke coming from the appliance, unplug it immediately, and contact an LG Electronics customer information center.
- Never unplug the appliance by pulling on the power cord. Always grip the plug firmly and pull straight out from the outlet.
- Do not use an extension cord or adapter with this appliance.
- Do not grasp the power cord or touch the appliance controls with wet hands.
- Do not modify or extend the power cord.
- If the appliance has been submerged, contact an LG Electronics customer information center for instructions before resuming use.
- Do not store or use gasoline or other flammable vapors and liquids in the vicinity of this or any other appliance.
- Keep the area underneath and around your appliances free of combustible materials (lint, paper, rags, etc.), gasoline, chemicals and other flammable vapors and liquids.
- This appliance is not intended for use by persons (including children) with reduced physical, sensory or mental capabilities, or lack of experience and knowledge, unless they have been given supervision or instruction concerning the use of the appliance by a person responsible for their safety.
- Use this appliance only for its intended purpose.
- Do not abuse, sit on, or stand on the door of the appliance.
- Do not allow children to play on, in or with the appliance. Close supervision of children is necessary when the appliance is used near children.
- Do not tamper with controls.
- In the event of a gas leak (propane gas, LP gas, etc.) do not operate this or any other appliance. Open a window or door to ventilate the area immediately.
- Under certain conditions, hydrogen gas may be produced in a hot-water system that has not been used for two weeks or more. **HYDROGEN GAS IS EXPLOSIVE.** If the hot-water system has not been used for such a period, before using the appliance turn on all hot water faucets and let the water flow from each for several minutes. This will release any accumulated hydrogen gas. As the gas is flammable, do not smoke or use an open flame during this time.
- Fix the drain hose securely in place.
- Do not put oily or greasy clothing, candles or flammable materials on top of the appliance.
- Do not use fabric softeners or products to eliminate static unless recommended by the manufacturer of the fabric softener or product.
- Do not reach into the appliance if the drum is moving.
- Do not dry articles that have been previously cleaned in, washed in, soaked in, soiled with or spotted with gasoline, dry cleaning solvents, vegetable oil, cooking oil or other flammable or explosive substances, as they give off vapors that could ignite or explode.
- Do not use heat to dry articles containing foam rubber or similarly textured rubber-like materials.
- Do not store plastic, paper, or clothing that may burn or melt on top of the dryer during operation.
- Gas appliances can cause minor exposure to four potentially hazardous substances, namely benzene, carbon monoxide, formaldehyde, and soot, caused primarily by the incomplete combustion of natural gas or LP fuels.
- Properly adjusted dryers will minimize incomplete combustion. Exposure to these substances can be minimized further by properly venting the dryer to the outdoors.
- Always check the inside of the appliance for foreign objects before use.
- Do not place items exposed to cooking oils in your appliance. Items contaminated with cooking oils may contribute to a chemical reaction that could cause a load to catch fire. To reduce the risk of fire due to contaminated loads, the final part of a tumble dryer cycle occurs without heat (cool down period). Avoid stopping a tumble dryer before the end of the drying cycle unless all items are quickly removed and spread out so that the heat is dissipated.
- Do not let children or pets climb inside the dryer drum.

- Do not put living animals such as pets inside the appliance.
- Do not put any part of your body, such as your hands or feet, or metal objects under the appliance.
- Do not let your hand get pinched when opening or closing the dryer door.
- Do not use replacement parts that have not been recommended by the manufacturer (e.g. parts made at home using a 3D printer).

Maintenance

- Do not repair or replace any part of the appliance. All repairs and servicing must be performed by qualified service personnel unless specifically recommended in this Owner's Manual. Use only authorized factory parts
- Do not disassemble or repair the appliance by yourself.
- Remove any dust or foreign matter from the power plug pins.
- Disconnect this appliance from the power supply before cleaning and attempting any user maintenance. Turning the controls to the OFF position does not disconnect this appliance from the power supply.
- Remove the door before the appliance is removed from service or discarded to avoid the danger of children or small animals getting trapped inside.
- Unplug the appliance before cleaning to avoid the risk of electric shock.
- The interior of the appliance and exhaust duct should be cleaned periodically by qualified service personnel.
- Certain internal parts are intentionally not grounded and may present a risk of electronic shock only during servicing. Service personnel - do not contact the following parts while the appliance is energized:
CONTROL BOARD

Steam

- Do not open the dryer door during a STEAM CYCLE.
- Do not touch the steam nozzle in the drum during or after a STEAM CYCLE.
- On models with a steam feeder tank, do not fill the steam feeder with hot water (over 86 °F / 30 °C), gasoline, dry cleaning solvents, or other flammable or explosive substances.

Grounding Instructions

- Improper connection of the equipment-grounding conductor can result in a risk of electric shock. Check with a qualified electrician or service personnel if you are in doubt whether the appliance is properly grounded. Do not modify the plug provided with the appliance; if it will not fit the outlet, have a proper outlet installed by a qualified electrician.
- The appliance must be grounded. In the event of a malfunction or breakdown, grounding will reduce the risk of electric shock by providing a path of least resistance for electric current. The appliance is equipped with a cord having an equipment-grounding conductor and a grounding plug. The plug must be plugged into an appropriate outlet that is installed and grounded in accordance with all local codes and ordinances.
- The appliance must be plugged into a properly grounded outlet. Electrical shock may result if the appliance is not properly grounded. Have the wall outlet and circuit checked by a qualified electrician to make sure the outlet is properly grounded. Failure to follow these instructions may create an electric shock hazard and/or a fire hazard.

SAVE THESE INSTRUCTIONS

PRODUCT OVERVIEW

Product Features

The images in this guide may be different from the actual components and accessories, which are subject to change by the manufacturer without prior notice for product improvement purposes.

Front View

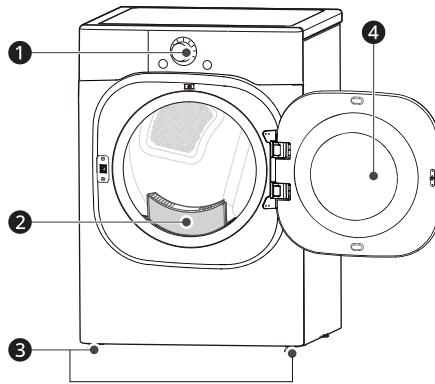

- ❶ Control Panel
- ❷ Lint filters
- ❸ Leveling feet
- ❹ Reversible door

Rear View

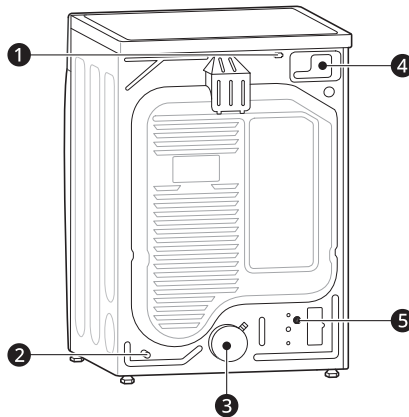

- ❶ Power Cord (for Gas Models)
- ❷ Gas Connection (for Gas Models)
- ❸ Exhaust Duct Outlet
- ❹ Terminal Block Access Panel (for Electric Models)
- ❺ Water Inlet Hose Connection (for Steam Models)

Product Specifications

Model		DL*X450**
Electrical Requirements		Please refer to the rating label for detailed information.
Min. / Max. Water Pressure		20 - 120 psi (138 - 827 kPa)
Dimensions (Width X Depth X Height)		27" X 30" X 39" (68.6 cm X 76.1 cm X 99 cm)
Maximum Depth with Door Open		51" (129.7 cm)
Net Weight		Gas : 140.4 lb (63.7 kg) Electric : 133.4 lb (60.5 kg)
Capacity	Steam Cycle	7.4 cu.ft. (8 lb / 3.6 kg)
	Normal Cycle	7.4 cu.ft. (22.5 lb / 10.2 kg)
Gas Requirements		NG: 4 - 10.5-inch (10.2 - 26.7 cm) WC WC LP: 8 - 13-inch (20.4 - 33.1 cm) WC



Accessories

Included Accessories



- 1 Y Connector

Optional Accessories (sold separately)

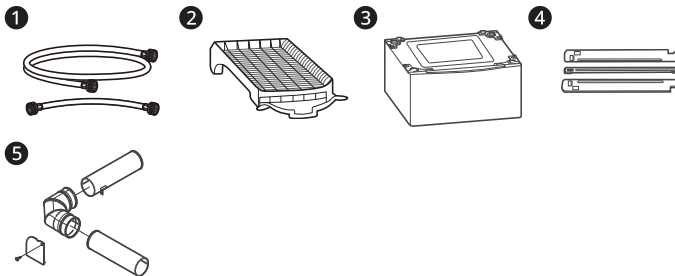

- 1 Hoses
- 2 Drying Rack
- 3 Pedestal
- 4 Stacking kit

10 PRODUCT OVERVIEW

5 Side vent kit (Kit No. 383EEL9001B)

NOTE

- For your safety and extended product life, use only authorized components. The manufacturer is not responsible for product malfunction or accidents caused by the use of unauthorized components or parts.
-

INSTALLATION

Before Installing

Installation Overview

Please read the following installation instructions first after purchasing this dryer or transporting it to another location.

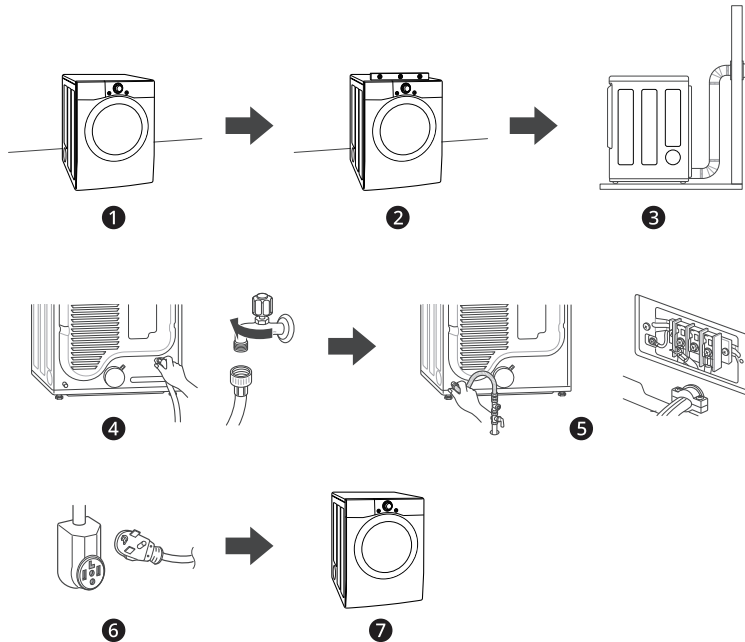

- ❶ Choose the proper location.
- ❷ Level the appliance.
- ❸ Vent the appliance.
- ❹ Connect the inlet hose (for steam models)
- ❺ Connect the Gas / Electric dryer.
 - Purchase a UL-listed, 3-wire or 4-wire power cord kit with UL-listed strain relief (electric dryer only)
- ❻ Plug in the power cord.
- ❼ Installation test and test run.
 - Refer to the **Test Exhaust System** section in **INSTALLATION**.

Choosing the Proper Location

⚠ WARNING

- Read all installation instructions completely before installing and operating the appliance. It is important that you review this entire manual before installing and using the appliance. Detailed instructions concerning electrical connections and additional requirements are provided on the following pages.
-

Exhaust

- The location must allow for proper exhaust installation. A gas dryer must be exhausted to the outdoors.

Electricity

Use an individual, grounded electrical outlet located within 2 ft. (61 cm) of either side of the appliance.

⚠ WARNING

- Do not install or store the appliance in an area where it will be exposed to water and/or weather.
-

NOTE

- Check code requirements that limit, or do not permit, installation of the dryer in garages, mobile homes or sleeping quarters. If you have questions, contact your local building inspector.
-

Flooring

To avoid noise and vibration, the appliance must be installed and leveled on a solidly constructed floor with a maximum slope of 1 inch (2.5 cm). If required, adjust the leveling legs to compensate for the unevenness of the floor.

NOTE

- A sturdy floor is needed to support the total appliance weight when loaded. The combined weight of additional appliances should also be considered.
- Clothes may not tumble properly, and automatic sensor cycles may not operate correctly if the appliance is not level.

- For garage installation, you will need to place the appliance at least 18 inches (45.7 cm) above the floor. The standard pedestal height is 15 inches (38 cm). You will need 18 inches (45.7 cm) from the garage floor to the bottom of the appliance.
-

Ambient Temperature

Install the appliance in an area where the temperature is over 45 °F (7 °C).

If the temperature around the appliance is too low, the appliance might not shut off at the end of an automatic cycle. This can result in longer drying times.

Dimensions and Clearances

The following clearances are recommended for the appliance.

- Additional clearances should be considered for ease of installation and servicing.
- Additional clearances should be considered on all sides of the dryer to reduce noise transfer.

Installation Spacing for Recessed Area or Closet Installation

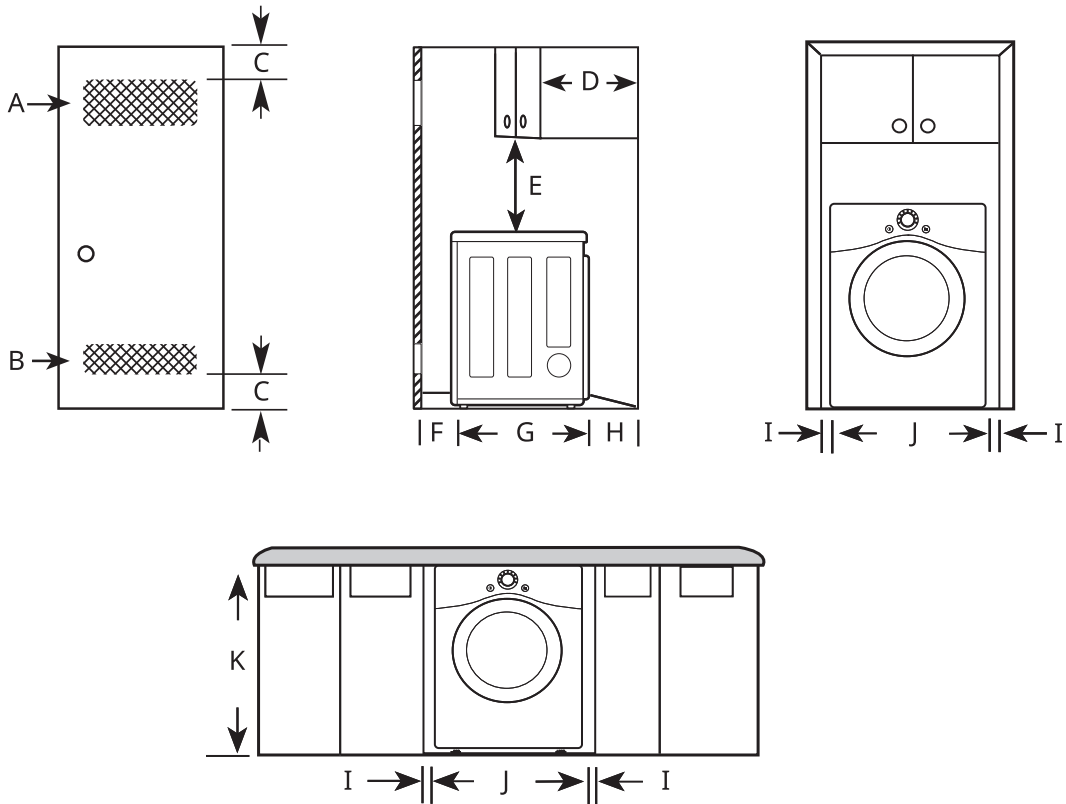

-	Description	Dimension/Clearance
A	Upper Ventilation Opening	≥ 48 sq. in. (310 cm ²)
B	Lower Ventilation Opening	≥ 24 sq. in. (155 cm ²)
C	Distance to Ventilation Opening	≥ 3" (76 mm)
D	Overhead Cabinet Depth	≤ 14" (356 mm)
E	Distance to the Overhead Cabinet/Shelf	≥ 18" (457 mm)
F	Front Clearance	1" (25 mm)
G	Depth	30 1/8" (765 mm)
H	Back Clearance	≥ 5" (127 mm)
I	Side Clearance	≥ 1" (25 mm)
J	Width	27" (686 mm)
K	Height of Cabinet Opening	39" (990 mm)

Closet Ventilation Requirements

Closets with doors must have both an upper and lower vent to prevent heat and moisture buildup in the closet. One upper vent opening with a minimum opening of 48 sq. in. (310 cm²) must be installed no lower than 6 feet above the floor. One lower vent opening with a minimum opening of 24 sq. in. (155 cm²) must be installed no more than one foot above the floor. Install vent grilles in the door or cut down the door at the top and bottom to form openings. Louvered doors with equivalent ventilation openings are also acceptable.

NOTE

- There should be at least a little space around the dryer (or any other appliance) to eliminate the transfer of vibration from one appliance to another. If there is enough vibration, it could cause appliances to make noise or come into contact, causing paint damage and further increasing noise.
- No other fuel-burning appliance can be installed in the same closet as a dryer.

Installation Spacing for Recessed Area or Closet, with Stacked Washer and Dryer

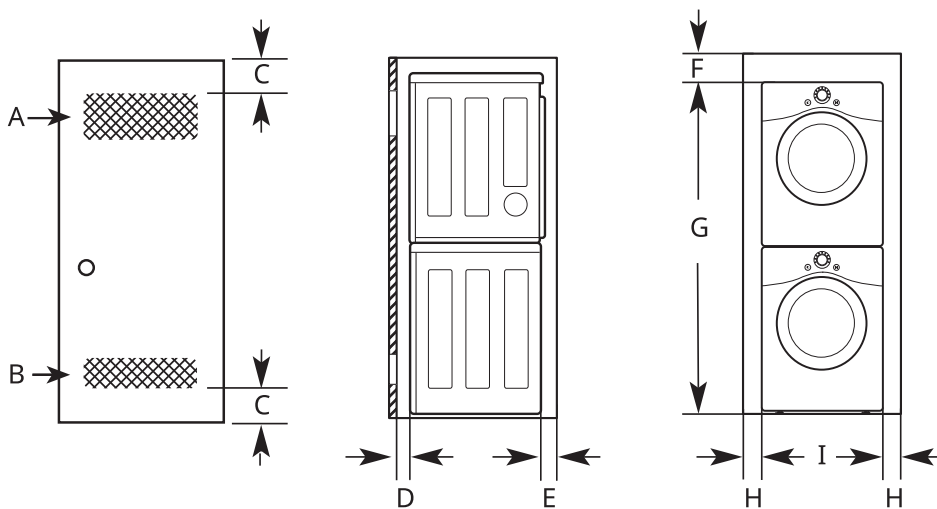

-	Description	Dimension/Clearance
A	Upper Ventilation Opening	≥ 48 sq. in. (310 cm ²)
B	Lower Ventilation Opening	≥ 24 sq. in. (155 cm ²)
C	Distance to Ventilation Opening	≥ 3" (76 mm)
D	Front Clearance	≥ 1" (25 mm)
E	Back Clearance	≥ 5 1/2" (140 mm)
F	Top Clearance to the Ceiling	≥ 6" (152 mm)
G	Height to the Top of Stacked Appliances [†]	77 1/2" (1968 mm)
H	Side Clearance	≥ 1" (25 mm)
I	Width [†]	27" (686 mm)

[†] Differs depending on the washer dimensions.

Installation Spacing for Cabinet

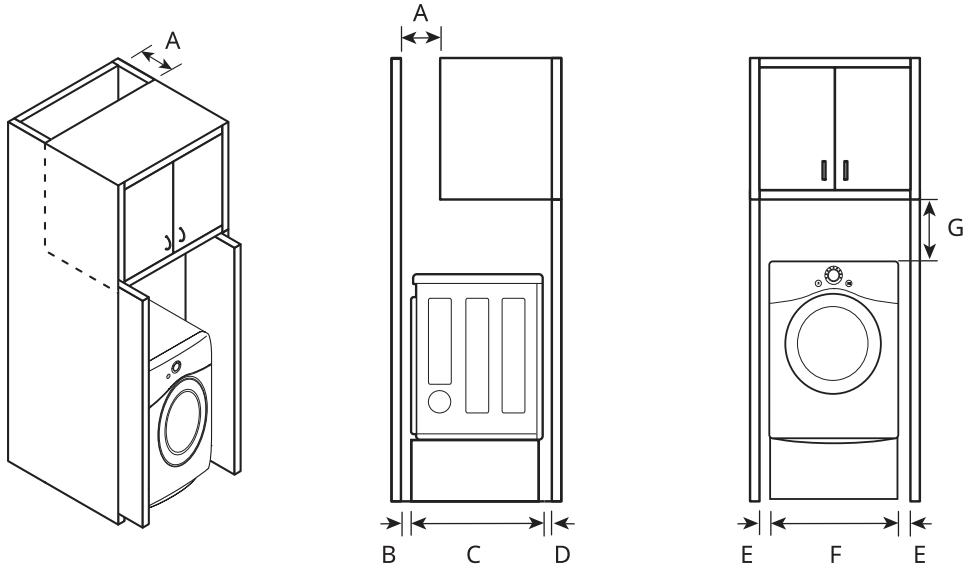

For cabinet installation with a door, minimum ventilation openings in the top of the cabinet are required.

-	Description	Dimension/Clearance
A	Depth of Ventilation Opening	≥ 7" (178 mm)
B	Back Clearance	≥ 5" (127 mm)
C	Depth	30 1/8" (765 mm)
D	Front Clearance	≥ 1" (25mm)
E	Side Clearance	≥ 1" (25 mm)
F	Width	27" (686 mm)
G	Clearance to Top of Cabinet	≥ 9" (229 mm)

Leveling the Appliance

⚠ WARNING

- Use long-sleeved gloves and safety glasses.
- The appliance is heavy. Two or more people are required when installing the appliance.

Checking the Level

Position the appliance in the final location and place a level across the top of the appliance.

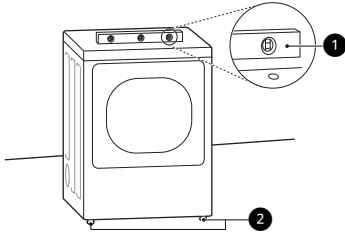

- ① Level
- ② Leveling Feet

NOTE

- All four leveling feet must rest solidly on the floor. Gently push on the top corners of the appliance to make sure that the appliance does not rock from corner to corner.
- Adjust the leveling feet only as far as necessary to level the appliance. Extending the leveling feet more than necessary may cause the appliance to vibrate.
- To ensure that the appliance provides optimal drying performance, it must be level. To minimize vibration, noise, and unwanted movement, the floor must be a perfectly level, solid surface.

Adjusting the Leveling Feet

Use an adjustable wrench to turn the leveling feet. Unscrew the legs to raise the appliance or screw in the legs to lower it. Raise or lower with the leveling feet until the appliance is level from side to side and front to back. Make sure that all four leveling feet are in firm contact with the floor.

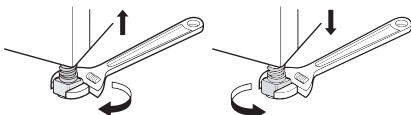

NOTE

- If you are installing the appliance on the optional pedestal, you must use the leveling feet on the pedestal to level the appliance. The appliance leveling feet should be fully retracted.

Reversing the Door

⚠ WARNING

- Support the door with a stool or box that fits under the door, or have an assistant support the weight of the door.
- Avoid dropping the door.
- Unplug the appliance or turn off power at the main circuit breaker before beginning door reversal.
- Always reverse the door BEFORE stacking the appliance on top of the washer.

Tools Required

- Phillips screwdriver
- Large flat blade screwdriver (recommended for hinge screws if they are tight or your Phillips screwdriver is worn)
- Small flat blade screwdriver (for lifting out parts)

Door Reversal Instructions

The instructions here are for changing the door swing from a right to a left side hinge. If the door has been reversed, and it is necessary to change it back, use care when following these instructions. Some of the illustrations and the left/right references will be reversed, and you will need to read the instructions carefully.

- 1 Open the appliance door.

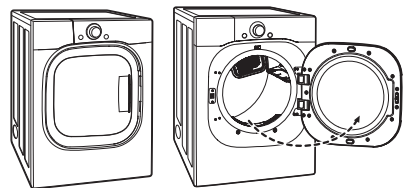

- 2 You will be removing the screws shown below (6 on left, 4 on right).

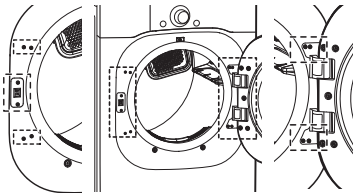

- 3** Remove the four decorative screws on the left using a screwdriver.

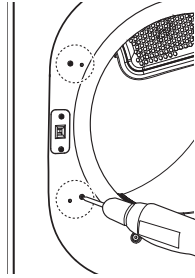

- 4** Remove the two latch screws and the latch.

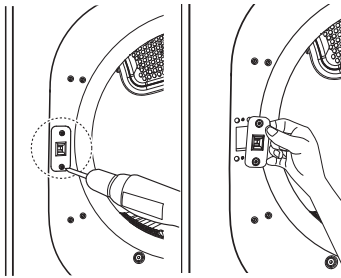

CAUTION

- Be sure to support the weight of the door before removing the hinge screws.

- 5** Hold the hinge in place while removing the four hinge screws (to prevent the door from dropping).

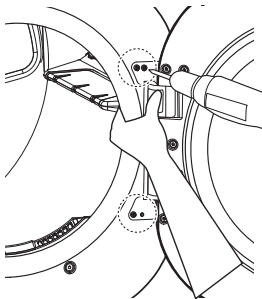

- 6** Remove the door from the cabinet cover.

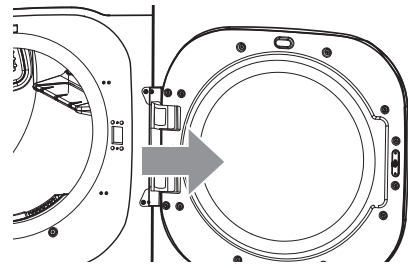

- 7** Move the door to the left side and line up the holes in the hinge with the holes in the cabinet.

WARNING

- Be sure to support the weight of the door before inserting the hinge screws.

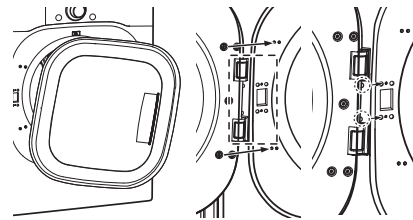

- 8** Hold the hinge in place while inserting the two hinge screws (to prevent the door from dropping).

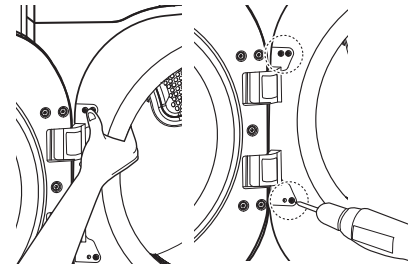

- 9** Insert the latch on the right side and install the latch screws.

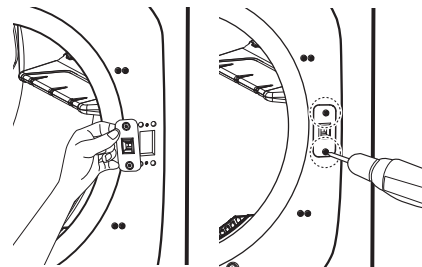

- 10** Insert the four decorative screws on the right side.

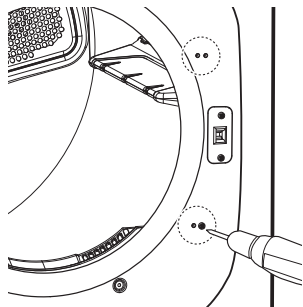

- 11** Check that the door closes and latches properly.

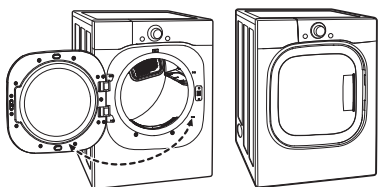

Installing the Vent Kit

⚠ WARNING

- Use long-sleeved gloves and safety glasses.
- Use a heavy metal vent.
- Do not use plastic or thin foil ducts.
- Clean old ducts before installing the appliance.

The appliance is configured to vent to the rear. It can also vent to the bottom or side.

NOTE

- An adapter kit, part number 383EEL9001B, may be purchased from your LG retailer. This kit contains duct components necessary to change the appliance vent location.
- Right-side venting is not available on gas models.

Side Venting

- 1** Remove the rear exhaust duct retaining screw **1** and pull out the exhaust duct **2**.

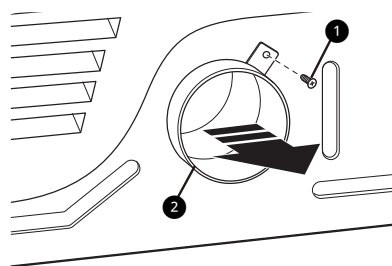

- 2** Press the tabs on the knockout **3** and carefully remove the knockout for the desired vent opening. (Right-side venting is not available on gas models.) Press the adapter duct **4** onto the blower housing and secure to the base of the dryer as shown.

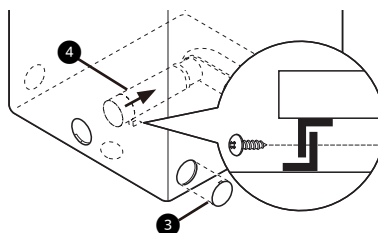

- 3** Preassemble a 4" (10.2 cm) elbow **5** to the next 4" (10.2 cm) duct section, and secure all joints with duct tape. Be sure that the male end of the elbow faces AWAY from the dryer. Insert the elbow/duct assembly through the side opening and press it onto the adapter duct. Secure it in place with duct tape. Be sure that the male end of the duct protrudes 1.5" (3.8 cm) to connect the remaining ductwork. Attach the cover plate **6** to the back of the dryer with the included screw.

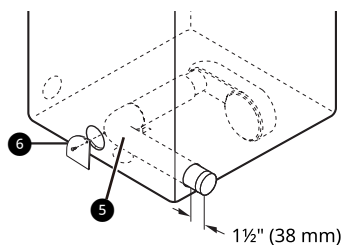

Bottom Venting

- 1** Remove the rear exhaust duct retaining screw **1**. Pull out the exhaust duct **2**.

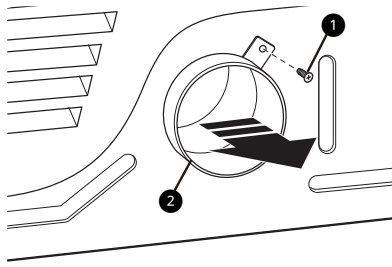

- 2** Press the adapter duct **3** onto the blower housing and secure it to the base of the dryer as shown.

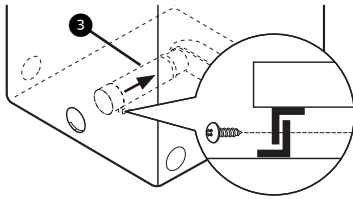

- 3** Insert the 4" (10.2 cm) elbow **4** through the rear opening and press it onto the adapter duct. Be sure that the male end of the elbow faces down through the hole in the bottom of the dryer. Secure it in place with duct tape. Attach the cover plate **5** to the back of the dryer with the included screw.

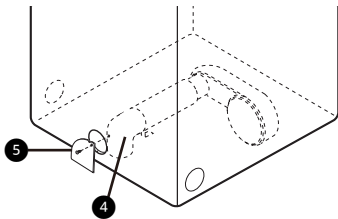

Stacking the Appliance

Tools Required

- Phillips screwdriver

Stacking Kit Installation

⚠ WARNING

- The weight of the appliance and the height of installation make this stacking procedure too risky for one person. Two or more people are required when installing the stacking kit.

- Place the washer on a solid, stable, level floor capable of supporting the weight of both appliances.
- Do not stack the washer on top of the dryer.
- If appliances are already installed, disconnect them from all power, water and drain connections.

This stacking kit includes:

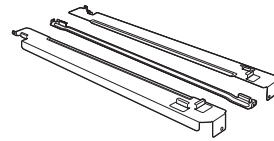

- Two (2) side rails
- One (1) front rail
- Four (4) screws

To ensure safe and secure installation, please observe the following instructions.

- 1** Make sure the surface of the washer is clean and dry. Remove paper backing from the tape on one of the stacking kit side brackets.

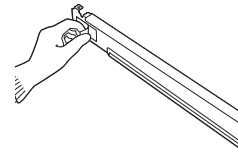

- 2** Fit the side bracket to the side of the washer top as shown. Firmly press the adhesive area of the bracket to the washer surface. Secure the side bracket to the washer with a screw on the back side of the bracket. Repeat steps 1 and 2 to attach the other side bracket.

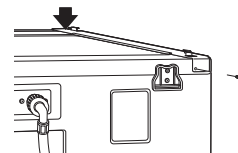

- 3** Place the appliance on top of the washer, fitting the dryer feet into the side brackets as illustrated. Avoid finger injuries; do not allow fingers to be pinched between the washer and the appliance. Slowly slide the appliance toward the back of the washer until the side bracket stoppers catch the dryer feet.

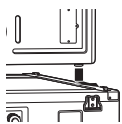

- 4** Insert the front rail between the bottom of the appliance and the top of the washer. Push the front rail toward the back of the washer until it comes in contact with the side rail stoppers. Install the two remaining screws to secure the front rail to the side rails.

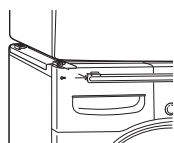

Venting the Dryer

⚠ WARNING

- Gas dryers **MUST** exhaust to the outdoors.
- To reduce the risk of fire, combustion, or accumulation of combustible gases, **DO NOT** exhaust dryer air into an enclosed and unventilated area, such as an attic, wall, ceiling, crawl space, chimney, gas vent, or concealed space of a building.
- To reduce the risk of fire, **DO NOT** exhaust the dryer with plastic or thin foil ducting.
- Do not exceed the recommended duct length limitations noted in the chart. Failure to follow these instructions may result in extended drying times, fire or death.

- Do not crush or collapse ductwork.
- Do not allow ductwork to rest on or contact sharp objects.
- If connecting to existing ductwork, make sure it is suitable and clean before installing the dryer.
- Venting must conform to local building codes.
- Use only 4-inch (10.2 cm) rigid, semi-rigid or flexible metal ductwork inside the dryer cabinet and for venting outside.
- The exhaust duct must be 4 inches (10.2 cm) in diameter with no obstructions. The exhaust duct should be kept as short as possible. Make sure to clean any old ducts before installing the new dryer.
- Rigid, semi-rigid or flexible metal ducting is recommended for use between the dryer and

the wall. All non-rigid metal transition duct must be UL-listed. Use of other materials for transition duct could affect drying time.

- **DO NOT** use sheet metal screws or other fasteners which extend into the duct that could catch lint and reduce the efficiency of the exhaust system. Secure all joints with duct tape.
- Ductwork is not provided with the dryer. You should obtain the necessary ductwork locally. The vent hood should have hinged dampers to prevent backdraft when the dryer is not in use.
- The total length of flexible metal duct must not exceed 8 ft. (2.4 m).
- When pushing the dryer into the installed position, do not crush or collapse ductwork.

Ductwork

Wall Cap Type	No. of 90° Elbows	Maximum length of 4-inch diameter rigid metal duct
 a: 4" (10.2 cm)	0	65 ft. (19.8 m)
	1	55 ft. (16.8 m)
	2	47 ft. (14.3 m)
	3	36 ft. (11.0 m)
	4	28 ft. (8.5 m)
 b: 2.5" (6.35 cm)	0	55 ft. (16.8 m)
	1	47 ft. (14.3 m)
	2	41 ft. (12.5 m)
	3	30 ft. (9.1 m)
	4	22 ft. (6.7 m)

NOTE

- Deduct 6 ft. (1.8 m) for each additional elbow. Do not use more than four 90° elbows.
- In Canada, only those foil-type flexible ducts, if any, specifically identified for use with the appliance by the manufacturer should be used. In the United States, only those foil-type flexible ducts, if any, specifically identified for use with the appliance by the manufacturer and that comply with the Outline for Clothes Dryer Transition Duct, Subject 2158A, should be used.

Routing and Connecting Ductwork

Follow the guidelines below to maximize drying performance and reduce lint buildup and condensation in the ductwork. Ductwork and fittings are NOT included and must be purchased separately.

- Use 4-inch (10.2 cm) diameter rigid, semi-rigid or flexible metal ductwork.
- The exhaust duct run should be as short as possible.
- Use as few elbow joints as possible.
- The male end of each section of exhaust duct must point away from the dryer.
- Use duct tape on all duct joints.
- Insulate ductwork that runs through unheated areas in order to reduce condensation and lint buildup on duct surfaces.
- Incorrect or inadequate exhaust systems are not covered by the dryer warranty. Dryer failures or service required because of such exhaust systems will not be covered by the dryer warranty.

Correct Venting

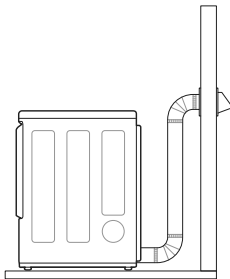

Incorrect Venting

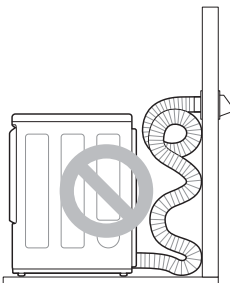

Connecting Gas Dryers

⚠ WARNING

- To reduce the risk of fire or explosion, electric shock, property damage, injury to persons, or

death when using this appliance, follow requirements including the following.

Electrical Requirements for Gas Models

⚠ WARNING

- This dryer is equipped with a three-prong grounding plug for protection against shock hazard which should be plugged directly into a properly grounded three-prong receptacle. Do not cut or remove the grounding prong from this plug.
- Do not, under any circumstances, cut or remove the third (ground) prong from the power cord.
- For personal safety, this dryer must be properly grounded.
- This dryer must be plugged into a 120-VAC, 60-Hz. grounded outlet protected by a 15-ampere fuse or circuit breaker.
- Where a standard 2-prong wall outlet is encountered, it is your personal responsibility and obligation to have it replaced with a properly grounded 3-prong wall outlet.

Gas Supply Requirements

⚠ WARNING

- DO NOT attempt any disassembly of the dryer; disassembly requires the attention and tools of an authorized and qualified service technician or company.
- DO NOT use an open flame to inspect for gas leaks. Use a noncorrosive leak detection fluid.
- Gas pressure must not exceed 10.5-inch (26.7 cm) water column for NG, or 13-inch (33.1 cm) water column for LP.
- Isolate the dryer from the gas supply system by closing its individual manual shutoff valve during any pressure testing of the gas supply at pressures greater than 3.5 kPa.
- Supply line requirements: Your laundry room must have a rigid gas supply line to your dryer. In the United States, an individual manual shutoff valve MUST be installed within at least 6 ft. (1.8 m) of the dryer, in accordance with the National Fuel Gas Code ANSI Z223.1 or Canadian gas installation code CSA B149.1. A 1/8-inch NPT plug must be installed.

22 INSTALLATION

- If using a rigid pipe, the rigid pipe should be 0.5-inch IPS. If acceptable under local codes and ordinances and when acceptable to your gas supplier, 3/8-inch approved tubing may be used where lengths are less than 20 ft. (6.1 m). Larger tubing should be used for lengths in excess of 20 ft. (6.1 m).
- To prevent contamination of the gas valve, purge the gas supply of air and sediment before connecting the gas supply to the dryer. Before tightening the connection between the gas supply and the dryer, purge remaining air until the odor of gas is detected.
- Use only a new AGA- or CSA-certified gas supply line (in compliance with the Standard for Connectors for Gas Appliances, ANSI Z21.24 • CSA 6.10) with flexible stainless steel connectors.
- Use Teflon tape or a pipe-joint compound that is insoluble in propane (LP) gas on all pipe threads.

Connecting the Gas Supply

NOTE

- In the Commonwealth of Massachusetts: This product must be installed by a licensed plumber or gas fitter. When using ball-type gas shut off valves, they must be T-handle-type. A flexible gas connector, when used, must not exceed 3 feet.

- Installation and service must be performed by a qualified installer, service agency, or the gas supplier.
- The dryer is configured for natural gas when shipped from the factory. Make sure that the dryer is equipped with the correct burner nozzle for the type of gas being used (natural gas or propane gas).
- Use only a new stainless steel flexible connector and a new AGA-certified connector.
- A gas shutoff valve must be installed within 6 ft. (1.8 m) of the dryer.
- If necessary, the correct nozzle should be installed by a qualified technician and the change should be noted on the dryer. (For the LP nozzle kit, order part number **383EEL3002D**.)
- All connections must be in accordance with local codes and regulations. Gas dryers MUST exhaust to the outdoors.

- 1** Make sure that the gas supply to the laundry room is turned OFF and the dryer is unplugged. Confirm that the type of gas available in your laundry room is appropriate for the dryer.

- 2** Remove the shipping cap from the gas fitting at the back of the dryer. Be careful not to damage the threads of the gas connector when removing the shipping cap.
- 3** Connect the dryer to your laundry room's gas supply using a new flexible stainless steel connector with a 3/8-inch NPT fitting.

⚠ WARNING

- DO NOT use old connectors.

- 4** Securely tighten all connections between the dryer and your laundry room's gas supply.
- 5** Turn on your laundry room's gas supply.
- 6** Check all pipe connections (both internal and external) for gas leaks with a noncorrosive leak-detection fluid.
- 7** Proceed to Venting the Dryer.

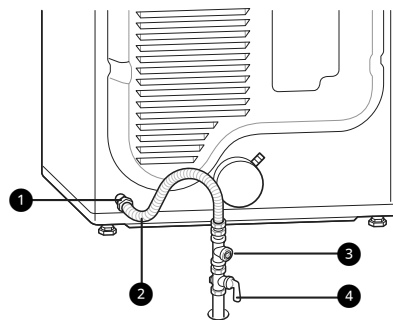

- 1** 3/8" NPT gas Connection
- 2** AGA/CSA-Certified Stainless Steel Flexible Connector
- 3** 1/8" NPT Pipe Plug
- 4** Gas Supply Shutoff Valve

High-Altitude Installations

The BTU rating of this dryer is AGA-certified for elevations below 10,000 feet.

If your gas dryer is being installed at an elevation above 10,000 feet, it must be derated by a qualified technician or gas supplier.

Connecting Electric Dryers

⚠ WARNING

- To reduce the risk of fire or explosion, electric shock, property damage, injury to persons, or death when using this appliance, fulfill the following requirements.

Electrical Requirements for Electric Models

⚠ WARNING

- The wiring and grounding must conform to the latest edition of the National Electrical Code, ANSI/NFPA 70 and all applicable local regulations. Please contact a qualified electrician to check your home's wiring and fuses to ensure that your home has adequate electrical power to operate the appliance.
- This appliance must be connected to a grounded metal, permanent wiring system, or an equipment-grounding conductor must be run with the circuit conductors and connected to the equipment-grounding terminal or lead on the appliance.
- The appliance has its own terminal block that must be connected to a separate 240 VAC, 60-Hertz, single-phase circuit, fused at 30 amperes. (The circuit must be fused on both sides of the line.) ELECTRICAL SERVICE FOR THE APPLIANCE SHOULD BE OF THE MAXIMUM RATE VOLTAGE LISTED ON THE NAMEPLATE. DO NOT CONNECT THE APPLIANCE TO 110-, 115-, OR 120-VOLT CIRCUIT.
- If the branch circuit to appliance is 15 ft. (4.5 m) or less in length, use UL (Underwriters Laboratories) listed No.-10 AWG wire (copper wire only), or as required by local codes. If over 15 ft. (4.5 m), use UL-listed No.-8 AWG wire (copper wire only), or as required by local codes. Allow sufficient slack in wiring so the appliance can be moved from its normal location when necessary.
- The power cord (pigtail) connection between the wall receptacle and the appliance terminal block IS NOT supplied with the appliance. Type of pigtail and gauge of wire must conform to local codes and with instructions on the following pages.
- Do not modify the plug and internal wire provided with the appliance.
- The appliance should be connected to a 4-hole outlet.

- If the plug does not fit the outlet, a proper outlet will need to be installed by a qualified electrician.
- Connect the power cord to the terminal block. Each colored wire should be connected to the same color screw. Wire color indicated in manual is connected to the same color screw in the block.
- Grounding through the neutral conductor is prohibited for: (1) new branch-circuit installations and (2) areas where local codes prohibit grounding through the neutral conductor.
- This appliance is supplied with the neutral wire grounded. This white ground wire **MUST BE MOVED** to the neutral terminal when a 4-wire cord is to be used, or where grounding through the neutral conductor is prohibited.

Four-Wire Power Cord

- A UL-listed strain relief is required.

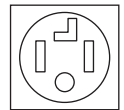

- Use a 30-amp, 240-volt, 4-wire, UL-listed power cord with #10 AWG-minimum copper conductor and closed loop or forked terminals with upturned ends.

- 1 Remove the terminal block access cover on the upper back of the appliance.
- 2 Install UL-listed strain relief into the power cord through-hole.
- 3 Thread a 30-amp, 240-volt, 4-wire, UL-listed power cord with #10 AWG-minimum copper conductor through the strain relief.

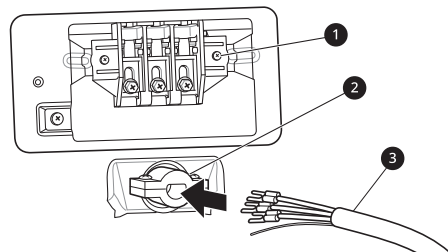

- ① Terminal Block
- ② UL-Listed Strain Relief

24 INSTALLATION

③ UL-Listed 4-Wire Power Cord

- 4 Transfer the appliance's ground wire from behind the green ground screw to the center screw of the terminal block.
- 5 Attach the two hot leads (black and red) of the power cord to the outer terminal block screws.
- 6 Attach the neutral (white) wire to the center screw of the terminal block.
- 7 Attach the power cord ground wire to the green ground screw.
- 8 Tighten all screws securely.
- 9 Reinstall the terminal block access cover.

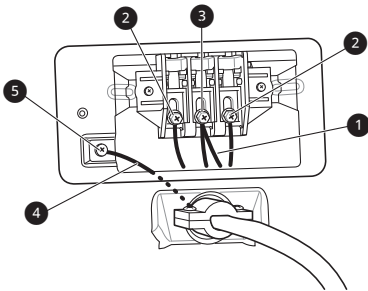

- ① White Wire moved from Ground Screw
- ② Hot Leads of Power Cord (Black and Red)
- ③ Neutral Wire (White)
- ④ Power Cord Ground Wire
- ⑤ Ground Screw

Four-Wire Direct Wire

- A UL-listed strain relief is required.

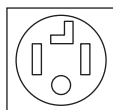

- Use UL-listed 4-wire #10 AWG minimum copper conductor cable. Allow at least 5 ft. (1.5 m) of wire to allow for removal and reinstallation of the dryer.

- 1 Remove 5 inches (12.7 cm) of the outer covering from the wire and remove 5 inches of insulation from the ground wire. Cut off approximately 1.5 inches (3.8 cm) from the other three wires and strip 1 inch (2.5 cm) insulation from each wire. Bend the ends of the three shorter wires into a hook shape.

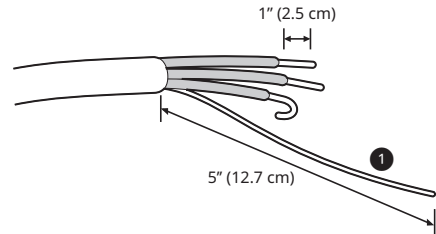

① Ground Wire

- 2 Remove the terminal block access cover on the upper back of the appliance.
- 3 Install UL-listed strain relief into the power cord through-hole.
- 4 Thread the 4-wire #10 AWG minimum copper power cable prepared in step 1 through the strain relief.

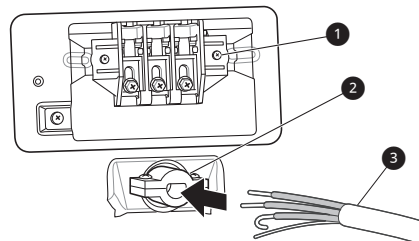

- ① Terminal Block
- ② UL-Listed Strain Relief
- ③ UL-Listed 4-Wire Power Cord

- 5 Transfer the appliance's ground wire from behind the green ground screw to the center of the terminal block.

- 6 Attach the two hot leads (black and red) of the power cord to the outer terminal block screws.
- 7 Attach the neutral (white) wire to the center screw of the terminal block.
- 8 Attach the power cord ground wire to the green ground screw.
- 9 Tighten all screws securely.
- 10 Reinstall the terminal block access cover.

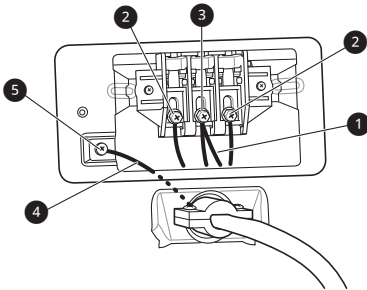

- 1 White Wire moved from Ground Screw
- 2 Hot Leads of Power Cord (Black and Red)
- 3 Neutral Wire (White)
- 4 Power Cord Ground Wire
- 5 Ground Screw

Three-Wire Power Cord

- A 3-wire connection is NOT permitted on new construction after January 1, 1996.



- A UL-listed strain relief is required.
- Use a 30-amp, 240-volt, 3-wire, UL-listed power cord with #10 AWG-minimum copper conductor and closed loop or forked terminals with upturned ends.

- 1 Remove the terminal block access cover on the upper back of the appliance.

- 2 Install the UL-listed strain relief into the power cord through-hole.
- 3 Thread a 30-amp, 240 volt, 3-wire, UL-listed power cord with #10 AWG-minimum copper conductor through the strain relief.

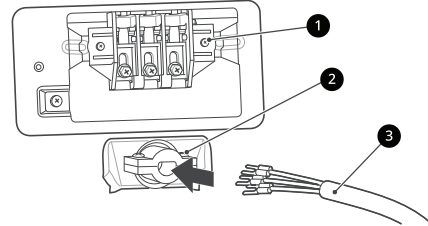

- 1 Terminal Block
- 2 UL-Listed Strain Relief
- 3 UL-Listed 3-Wire Power Cord

- 4 Attach the two hot leads (black and red) of the power cord to the outer terminal block screws.
- 5 Attach the neutral (white) wire to the center terminal block screw.
- 6 Connect the external ground (if required by local codes) to the green ground screw.
- 7 Tighten all screws securely.
- 8 Reinstall the terminal block access cover.

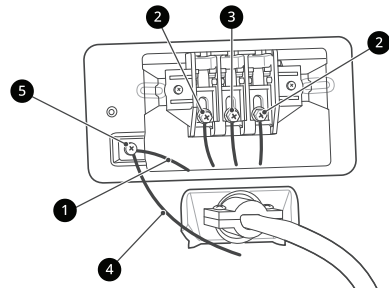

- 1 White Wire from Dryer Harness
- 2 Hot Leads of Power Cord (Black and Red)
- 3 Neutral Wire (White)
- 4 External Ground Wire (if required by local codes)

5 Ground Screw

Three-Wire Direct Wire

- A 3-wire connection is NOT permitted on new construction after January 1, 1996.



- A UL-listed strain relief is required.
- Use UL-listed 3-wire, #10 AWG minimum copper conductor cable. Allow at least 5 ft. (1.5 m) length to allow for removal and installation of dryer.

- 1 Remove 3.5 inches (8.9 cm) of the outer covering from the wire. Strip 1 inch (2.5 cm) insulation from each wire. Bend the ends of the three wires into a hook shape.

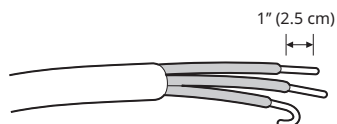

- 2 Remove the terminal block access cover on the upper back of the appliance.
- 3 Install UL-listed strain relief into the power cord through-hole.
- 4 Thread the 3-wire, #10 AWG minimum copper conductor power cable prepared in step 1 through the strain relief.

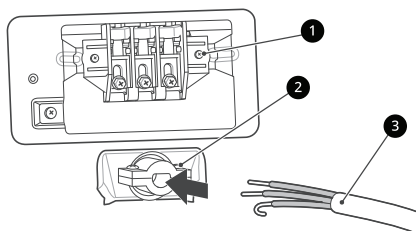

- 1 Terminal block
- 2 UL-listed strain relief
- 3 UL-listed 3-wire power cord

- 5 Attach the two hot leads (black and red) of the power cord to the outer terminal block screws.

- 6 Attach the neutral (white) wire to the center terminal block screw.
- 7 Connect the external ground (if required by local codes) to the green ground screw.
- 8 Tighten all screws securely.
- 9 Reinstall the terminal block access cover.

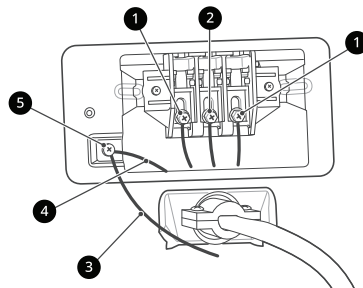

- 1 Hot lead (black and red)
- 2 Neutral wire (white)
- 3 External ground wire (if required by local codes)
- 4 Wire from the appliance harness
- 5 Ground screw (green)

Connecting the Water Inlet Hose

To generate steam, the dryer must be connected to the cold water tap using a new water supply hose. Do not use old hoses.

⚠ WARNING

- Do not overtighten the hoses or cross-thread the hose fittings. Overtightening or cross-threading can damage the valves or couplings, resulting in leaking and property damage.
- Do not reuse old hoses. Use only new hoses when installing the appliance. Old hoses could leak or burst causing flooding and property damage. Contact an LG Customer Information Center for assistance in buying hoses.

⚠ CAUTION

- Periodically check the hoses for cracks, leaks, and wear, and replace the hoses every five years.

- Do not stretch the water hoses intentionally, and make sure that they are not pinched, crushed or kinked by other objects.
- Water supply pressure must be between 20 psi and 120 psi (138 - 827 kPa). If the water supply pressure is more than 120 psi, a pressure reducing valve must be installed.
- Do not store or install the appliance in a location subject to freezing temperatures. Damage to the water inlet hoses and internal mechanisms of the appliance can result. If the appliance was exposed to freezing temperatures prior to installation, allow it to stand at room temperature for several hours before use and check for leaks prior to operation.
- Do not use flood-preventing hoses with auto shut off devices. The devices can be tripped during fill and prevent the appliance from filling properly.
- If your water supply contains a lot of debris, a whole home water filter may help to remove the debris from the water before it reaches the dryer inlets.

How to Connect the Water Inlet Hoses

- 1 Check the fittings and seals. Inspect the threaded fitting on each hose and make sure there is a rubber seal ❶ in place in both ends of each hose to prevent leaking.

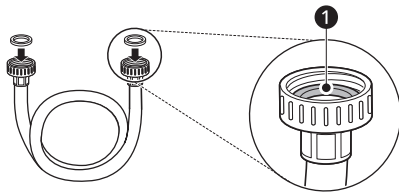

- 2 Check the type of installation and connect the hose to the faucet. Connect all water supply hoses tightly by hand and then tighten another 2/3 turn with pliers.

- Type 1 : WITHOUT WASHER (The dryer does not share the faucet with the washing machine.)

- 1) Connect the straight end of the long hose ❷ to the cold water faucet.

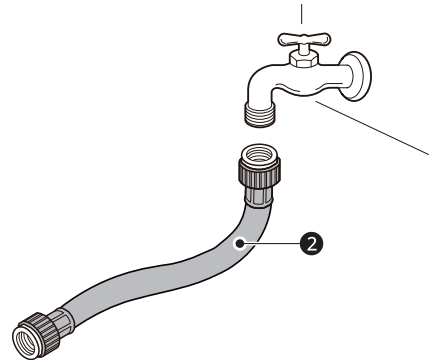

- Type 2 : WITH WASHER (The dryer shares the faucet with the washing machine.)

- 1) Shut off the cold water tap and remove the washer inlet hose.
- 2) Connect the short hose ❸ to the Y-connector ❹ using one of the rubber seals.
- 3) Connect the other end of the short hose ❸ to the cold water faucet.
- 4) Connect the long dryer hose ❷ to one side of the Y-connector ❹. Connect the washer hose to the washer and the other side of the Y-connector ❹.

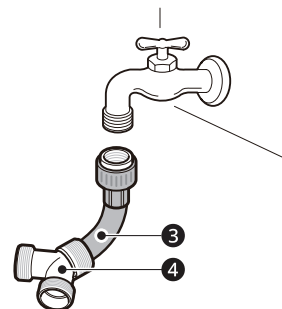

NOTE

- Before connecting the water line to the dryer, flush several gallons of water into a drain or bucket. This will help prevent foreign particles such as sand and scale from clogging the dryer inlet valve.

- 3** Connect the long dryer hose **2** to the dryer inlet valve tightly by hand and then tighten another 2/3 turn with pliers.

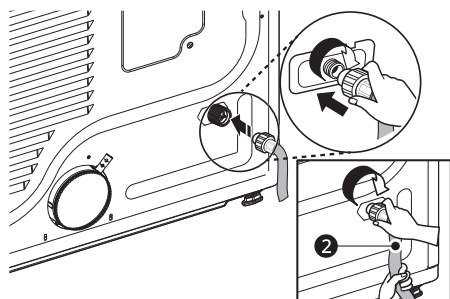

- 4** Turn on the cold water faucet.

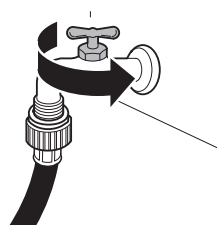

- 5** Check all hoses and Y-connectors (if used) for leaks.

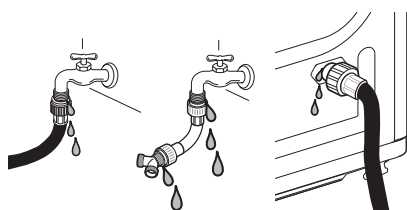
**NOTE**

- If any leaks are found, shut off the water faucet, remove the hose and check the condition of the rubber seal.
- In areas with hard water, mineral scale can form on internal components of the dryer. Use of a water softener is recommended in areas with

hard water. Excessive scale buildup may lead to the need for certain part replacement or repair.

Final Installation Check

Once you have completed the installation of the dryer and it is in its final location, confirm proper operation with the following tests.

Test Dryer Heating

Gas Models

Close the dryer door and press the **Power** button to turn the dryer on. Press the **Time Dry** and **Start/Pause** buttons to start the test. When the dryer starts, the igniter should ignite the main burner.

NOTE

- If all air is not purged from the gas line, the gas igniter may turn off before the main burner ignites. If this happens, the igniter will reattempt gas ignition after approximately two minutes.

Electric Models

Close the dryer door and press the **Power** button to turn the dryer on. Press the **Time Dry** and **Start/Pause** buttons to start the test. The exhaust air should be warm after the dryer has been operating for 3 minutes.

Checking Airflow

Effective dryer operation requires proper airflow. The adequacy of the airflow can be measured by evaluating the static pressure. Static pressure in the exhaust duct can be measured with a manometer, placed on the exhaust duct approximately 2 ft. (60.9 cm) from the dryer. Static pressure in the exhaust duct should not exceed 0.6 inch (1.5 cm). The dryer should be checked while the dryer is running with no load.

Checking Levelness

Once the dryer is in its final location, recheck the dryer to be sure it is level. Make sure it is level front to back and side to side, and that all four leveling feet are in firm contact with the floor.

Test Exhaust System

Once you have completed the installation of the appliance, use this test to make sure the condition of the exhaust system is adequate for proper operation of the appliance. This test should be performed to alert you to any serious problems in the exhaust system of your home.

- Your appliance features Flow Sense™, an innovative sensing system that automatically detects blockages and restrictions in dryer ductwork. Keeping ductwork clean of lint buildup and free of restrictions allows clothes to dry faster and reduces energy use.

NOTE

- The appliance should be cool before starting this test. If the appliance was warmed up during installation, run the **Air Dry** cycle for a few minutes to reduce the interior temperature.

Activating the Installation Test

- Remove the drying rack and literature, and then close the door.

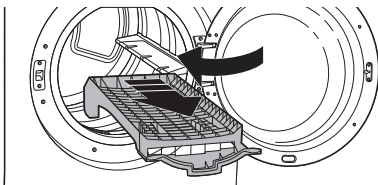

- Do not load anything in the drum for this test, as it may affect the accuracy of the results.

- Press and hold the **Signal** and **Temp.** buttons and then press the **Power** button.

- On models with a glass touch control panel, press the **Power** button then IMMEDIATELY press and hold the **Signal** and **Temp.** buttons.

- This button sequence activates the installation test. The code In5 will display if the activation is successful.

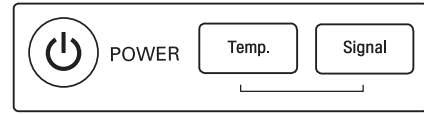

- Press the **Start/Pause** button.

- The appliance will start the test, which will last a few minutes. The heat will be turned on and the temperatures in the drum will be measured.

- Check the display for results.

- During the test cycle, monitor the Flow Sense™ display on the control panel. If the Flow Sense™ LED has not turned on when the cycle ends, the exhaust system is adequate. If the exhaust system is severely restricted, the Flow Sense™ LED will turn on. Other problems may also be shown with error codes. See the chart on the next page for error code details and solutions.
- If the Flow Sense™ LED indicates that the exhaust system is severely restricted, have the system checked immediately, as performance will be poor.



- End of cycle.

- At the end of the test cycle, **End** will display. The test cycle will end and the appliance will shut off automatically after a short delay.



Check the Duct Condition

If the Flow Sense™ LED is turned on, check the exhaust system for restrictions and damage. Repair or replace the exhaust system as needed.

NOTE

- When the appliance is first installed, this test should be performed to alert you to any existing problems with the exhaust duct in your home. However, since the test performed during normal operation provides more accurate information on the condition of the exhaust duct than the installation test, the results during the two tests may not be the same.
- Do not interrupt the test cycle, as this could result in inaccurate results.
- Even if the LED doesn't light up during the test cycle, some restrictions may still be present in the exhaust system. Refer to the **Venting the Dryer** section of this manual for complete exhaust system and venting requirements.

Error Codes

Check the error code before you call for service.

Error Code	Possible Cause & Solution
EE 1 or EE 2	<p>Temperature sensor failure.</p> <ul style="list-style-type: none"> • Turn off the appliance and call for service.
H5	<p>Humidity sensor failure.</p> <ul style="list-style-type: none"> • Turn off the appliance and call for service.
P5, PF, or nP	<p>Electric dryer power cord is not connected correctly, or house power supply is incorrect.</p> <ul style="list-style-type: none"> • Reset circuit breaker or replace fuse. Do not increase the fuse capacity.
	<p>House fuse is blown, circuit breaker has tripped, or power outage has occurred.</p> <ul style="list-style-type: none"> • If the problem is a circuit overload, have it corrected by a qualified electrician.
9A5	<p>Gas supply or service turned off. (Gas model only.)</p> <ul style="list-style-type: none"> • Confirm that house gas shutoff and the dryer gas shutoff are both fully open.

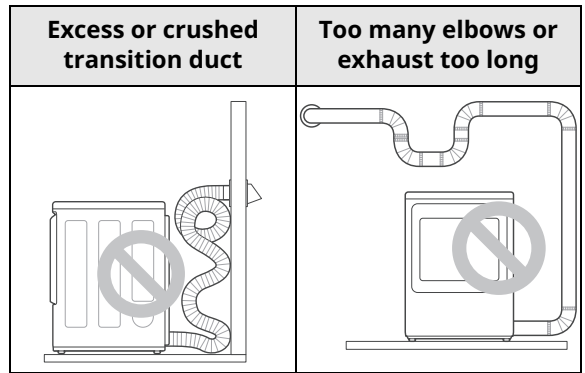

Check for blockages and lint buildup.

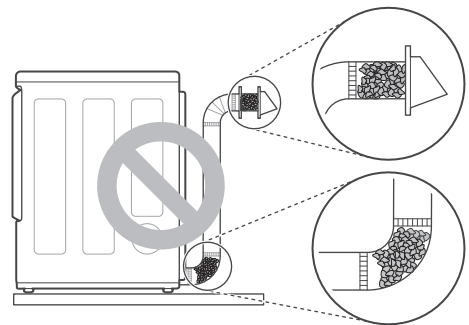

Make sure the ductwork is not crushed or restricted.

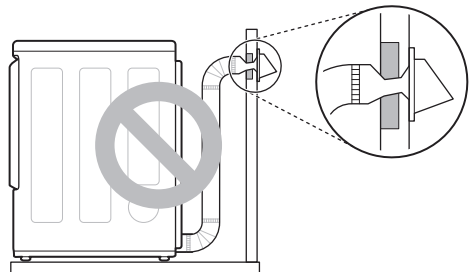

Restricted or Blocked Airflow

Avoid long runs or runs with multiple elbows or bends.

OPERATION

Before Use

WARNING

- To reduce the risk of fire, electric shock, or injury to persons, read the **IMPORTANT SAFETY INSTRUCTIONS** before operating this appliance.

Operation Overview

1 Clean the Lint Filter

- If the lint filter has not already been cleaned, lift out the filter and remove the lint from the last load. This will help ensure the fastest and most efficient drying performance. Make sure to reinstall the filter, pressing down until it clicks firmly into place.

2 Load the Dryer

- Make sure that clothing is pushed entirely into the drum and away from the door seal area. Clothing that gets stuck between the door and seal may be damaged or damage the seal.
- If the load is extra large, you may need to divide it into smaller loads for proper performance and fabric care.
- All strings and attached belts of clothes should be well tied and secured before being put into the drum.

3 Turn on the Dryer

- Press the **Power** button to turn on the dryer. The cycle LEDs will illuminate and a chime will sound.

4 Select a Cycle

- Turn the cycle selector knob in either direction until the LED for the desired cycle is on. The preset temperature, dry level, and option settings for that cycle will be shown.
- Pressing the **Start/Pause** button without selecting a cycle immediately starts the **Normal** cycle with the default settings. Select the **Normal** cycle to change the default settings.

5 Adjust Settings

Default settings for the selected cycle can now be changed, if desired, using the cycle modifier and option buttons.

- Not all modifiers and options are available on all cycles. A different chime will sound and the LED will not come on if the selection is not allowed.

6 Begin Cycle

- Press the **Start/Pause** button to begin the cycle. The cycle can be paused at any time either by opening the door or by pressing the **Start/Pause** button.
- If the **Start/Pause** button is not pressed within a certain time, the dryer shuts off and all settings are lost.

7 End of Cycle

- When the cycle is finished, the chime will sound. Immediately remove your clothing from the dryer to reduce wrinkling. If **Wrinkle Care** is selected, the dryer will tumble briefly every few minutes to help prevent wrinkles from setting in the clothes.

Check the Lint Filter Before Every Load

Always make sure the lint filter  is clean before starting a new load; a clogged lint filter will increase drying time. To clean, pull the lint filter straight up and roll any lint off the filter with your

fingers. Push the lint filter firmly back into place. See **Regular Cleaning** for more information.

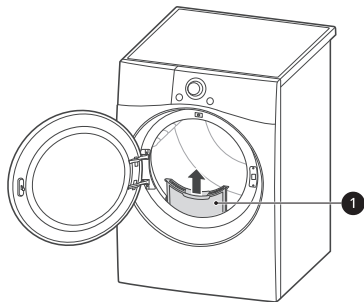

Always ensure that the lint filter is properly installed before running the dryer. Running the dryer with a loose or missing lint filter will damage the dryer and articles in the dryer.

Loading the Dryer

NOTE

- For the best drying performance and most efficient energy usage, do not overload the appliance.

General Tips

- Combine large and small items in the same load.
- Use mesh laundry bags to separate clothes with zippers, hooks, straps, and drawstrings to prevent them from catching on or tangling with other clothes or damaging the lint filter.

NOTE

- Damp clothes will expand as they dry. Do not overload the dryer; clothes require room to tumble and dry properly.

Grouping Similar Items

For the best drying results, and to reduce the possibility of damage to clothing, sort clothes into loads that can be dried with the same drying cycle.

Different fabrics have different care requirements, and some fabrics will dry more quickly than others.

Woolen Items

- Always follow fabric care labels before drying woolen items in a dryer. After the cycle, the items may still be damp. Do not repeat the cycle. Pull the items to their original shape if needed and lay them flat to finish drying.

Woven and Loopknit Materials

- Some woven and loopknit materials may shrink, depending on quality.

Permanent Press and Synthetics

- Do not overload your dryer. Take out permanent press items as soon as the dryer stops to reduce wrinkles.

Baby Clothes and Nightgowns

- Always check the manufacturer's instructions.

Rubber and Plastics

- Do not dry any items made from or containing rubber or plastics such as:
 - Aprons, bibs and chair covers
 - Curtains and tablecloths
 - Bath mats

Fiberglass





- Do not dry fiberglass articles in your dryer. Glass particles left in the dryer could be picked up by your clothes the next time you use the dryer and irritate your skin.



Fabric Care Labels





- Sort and dry laundry according to care labels, size, and fabric type. Do not overload the dryer. This will save energy and time and give the best drying performance.

Fabric Care Labels

Many articles of clothing include a fabric care label. Using the chart below, adjust the cycle and option selections to care for your clothing according to the manufacturer's recommendations.

Tumble Dry	
Label	Directions
	Dry
	Normal
	Permanent Press / Wrinkle Resistant
	Gentle / Delicate

Tumble Dry	
Label	Directions
	Do not tumble dry
	Do not dry (used with do not wash)

Heat Setting	
Label	Directions
	High
	Medium
	Low
	No Heat / Air

Control Panel

Control Panel Features

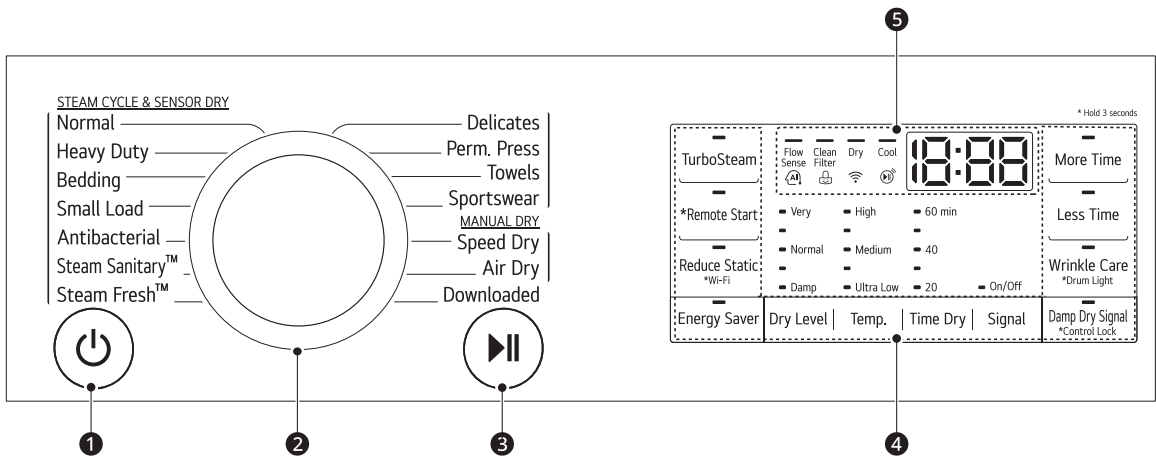

1 Power Button

- Press the button to turn the appliance on. Press again to turn the appliance off.

NOTE

- Pressing the **Power** button during a cycle will cancel that cycle, and any load settings will be lost.

2 Cycle Selector Knob

- Turn this knob to select the desired cycle. Once the desired cycle has been selected, the standard presets will be shown in the display. On Manual Dry cycles, these settings can be adjusted using the cycle modifier buttons anytime before starting the cycle.

3 Start/Pause Button

- Press this button to start the selected cycle. If the appliance is running, use this button to pause the cycle without losing the current settings.

NOTE

- If you do not press the **Start/Pause** button to resume a cycle within a certain time, the appliance turns off automatically and all cycle settings are lost.

4 Extra Options and Functions / Cycle Modifier Buttons

- Use these buttons to select the desired options for the selected cycle. Not all options are available for each cycle.
- **Remote Start**
 - With the **LG ThinQ** app, you can use a smartphone to control your appliance remotely.
- **Wi-Fi**
 - Press and hold the **Reduce Static** button for 3 seconds to initiate the connection of the appliance to the **LG ThinQ** application.

5 Time and Status Display

- The display shows the settings, estimated time remaining, options, and status messages for the appliance. When the appliance is turned on, the default settings in the display will illuminate.

Time and Status Display

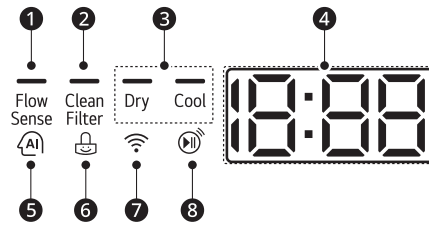

1 Flow Sense Indicator

- The Flow Sense™ duct blockage sensing system detects and alerts you to blockages in the ductwork that reduce exhaust flow from the dryer. Maintaining a clean exhaust system improves operating efficiency and helps minimize service calls, saving you money.

2 Clean Filter Reminder

- The **Clean Filter** indicator lights up at the beginning of the cycle to remind you to check the lint filter. It turns off when the **Start/Pause** button is pressed.

3 Cycle Status Indicators

- **Dry** lights up when the appliance is in the drying stage.
- **Cool** lights up when the appliance is in the cool down stage.

4 Estimated Time Remaining

- When a drying cycle is selected, the estimated drying time for the selected cycle is displayed. This time will change if you select extra options for the cycle.
- The cycle time on Sensor Dry cycles may fluctuate as the appliance recalculates drying time for optimal results.

5 AI lights up when the **Normal** cycle is selected with the **Normal** dry level, except when the **Energy Saver** option is turned on.

- This feature optimizes drying times and temperatures by detecting the laundry's characteristics.

6 Lock icon lights up when the control panel is locked.

7 Wi-Fi icon lights up when the appliance is connected to a home Wi-Fi network.

8 Speaker icon lights up when the remote control feature is activated.

Dry Cycles

Turn the knob or press the button to select the desired cycle. When you select a dry cycle the light for the corresponding dry cycle will turn on.

Sensor Dry Cycles

Sensor dry cycles utilize LG's unique dual sensor system to detect and compare the moisture level in clothes and in the air and adjust the drying time as needed to ensure superior results. The appliance automatically sets the dryness level and temperature at the recommended setting for each cycle. The estimated time remaining will be shown in the display.

• Very	• High
• More	• Med. High
• Normal	• Medium
• Less	• Low
• Damp	• Ultra Low
Dry Level Temp.	

Dry Level: Damp > Less > Normal > More > Very

Temperature: Ultra Low > Low > Medium > Med. High > High

Cycle	Normal	
Description	Use this cycle for drying all normal items such as cotton, linen, shirts, jeans or mixed loads, except delicate fabrics such as wool or silk.	
Dry Level	Default: Normal	Available: All
Temperature	Default: Med. High	Available: Med. High

Cycle	Heavy Duty	
Description	Use this cycle for drying heavy-duty clothes like jeans or garments that need extra drying.	
Dry Level	Default: Normal	Available: All
Temperature	Default: High	Available: High

Cycle	Bedding	
Description	Use this cycle for drying blankets or bulky items such as pillows, blankets, comforters, sheets or pet bedding.	
Dry Level	Default: Normal	Available: Very, More, Normal
Temperature	Default: Medium	Available: Medium

Cycle	Small Load	
Description	Use this cycle for drying light or small items. (up to 3 items)	
Dry Level	Default: Normal	Available: Very, More, Normal
Temperature	Default: High	Available: High

Cycle	Antibacterial	
Description	Use this cycle to help to reduce bacteria.	
Dry Level	Default: Very	Available: Very

Cycle	Antibacterial	
Temperature	Default: High	Available: High

Cycle	Delicates	
Description	Use this cycle for drying dress shirts/blouses, nylons, lingerie, or sheer and lacy clothes which can easily be damaged.	
Dry Level	Default: Normal	Available: All
Temperature	Default: Low	Available: Low

Cycle	Perm. Press	
Description	Use this cycle to minimize wrinkles when drying tablecloths or wrinkle-free clothes.	
Dry Level	Default: Normal	Available: All
Temperature	Default: Medium	Available: Medium

Cycle	Towels	
Description	Use this cycle for drying towels.	
Dry Level	Default: Normal	Available: All
Temperature	Default: Med. High	Available: Med. High

Cycle	Sportswear	
Description	Use this cycle for drying special garments for sports and outdoor wear.	
Dry Level	Not adjustable	
Temperature	Not adjustable	

Steam Cycles

LG's new steam technology injects fabrics with a swirling jet of hot steam to refresh clothes, reduce static, and make ironing easier.

Cycle	Steam Sanitary™	
Description	Use this cycle to reduce bacteria on laundry using TurboSteam.	
Dry Level	Not adjustable	
Temperature	Default: High	Available: High
Default Time	31 minutes	
Fabric Type (Max Amount)	<ul style="list-style-type: none"> • Comforter, Bedding (Single, 1 each) • Children's Clothing (3 lbs.) 	

Cycle	Steam Fresh™	
Description	Use this cycle to quickly reduce wrinkles and odors in fabrics using the power of steam.	
Dry Level	Not adjustable	

Cycle	Steam Fresh™	
Temperature	Default: Med. High	Available: All
Default Time	10 minutes	
Fabric Type (Max Amount)	<ul style="list-style-type: none"> • Comforter (Single, 1 each) • Shirts†(5 each) 	

† Shirts : 70% cotton, 30% poly blend. Except especially delicate fabrics

WARNING

- To reduce the risk of serious injury, death, explosion, or fire, follow basic safety precautions, including the following:
 - Do not open the dryer door during steam cycles.
 - Do not touch the steam nozzle in the drum during or after the steam cycle.
- Do not use steam cycles with the following clothes, as they may be damaged.
 - **Steam Sanitary™**: Urethane foam, down feathers or delicate items
 - **Steam Fresh™**: Wool, wool blankets, leather jackets, silk, lingerie, foam products, or electric blankets.

NOTE

- The **Steam Sanitary™** and **Steam Fresh™** cycles are designed for use with dry clothing.
- The cycle time of **Steam Fresh™** depends on the load (number of items). Press the **More Time** or **Less Time** button to change the display to reflect the number of items in the load. The display will show 1, 3, 5 or "bl 9". 1 means 1 item, 3 means 2 or 3 items, 5 is for 4 or 5 items, and bl 9 indicates a large load such as a comforter.

Manual Dry Cycles

Use Manual Dry cycles to select a specific amount of drying time. When a Manual Dry cycle is selected, the actual time remaining in your cycle appears on the display. You can change the actual time in the cycle by pressing the **More Time** or **Less Time** buttons.

Cycle	Speed Dry	
Description	Use this cycle to quickly dry a small load of laundry.	
Dry Level	Not adjustable	
Temperature	Default: High	Available: All

Cycle	Air Dry	
Description	Use this cycle to dry all items (such as plastics or rubber) that can be tumble dried without using heat.	
Dry Level	Not adjustable	
Temperature	Not adjustable	

Special Drying Cycles

Cycle	Downloaded
Description	<p>This cycle allows you to download a new and specialized drying cycle to your appliance with a smartphone.</p> <ul style="list-style-type: none"> Refer to the LG ThinQ smartphone application to see the cycles available for download.

Selectable Drying Options

Cycle	Option				
	TurboSteam	Reduce Static	Energy Saver [†]	Wrinkle Care	Damp Dry Signal
Normal	●	●	●	●	●
Heavy Duty	●	●		●	●
Bedding	●	●			
Small Load				●	
Antibacterial				●	
Steam Sanitary™	● (Not adjustable)			●	
Steam Fresh™	● (Not adjustable)			●	
Delicates		●		●	●
Perm. Press	●	●		●	●
Towels		●		●	●
Sportswear		●		●	
Speed Dry		●		●	
Air Dry				●	
Downloaded				●	

† This option helps to reduce the energy use by drying clothes at lower temperatures than the normal mode. When this option is set, the drying time will increase.

NOTE

- The **TurboSteam** and **Energy Saver** options cannot be used together.

Cycle Modifiers

- To turn the sounds on/off, press the **Signal** button. Alert sounds will still be audible.

About Modifier Buttons

Each cycle has default settings that are selected automatically. Customize these settings using the cycle modifier buttons. Repeatedly press the button for the desired modifier until the indicator light for the desired setting is lit. Not every option is available with every cycle. If a modifier is not available, the button chimes twice and the setting does not change.

■ Very	■ High	■ 60 min	
■	■	■	
■ Normal	■ Medium	■ 40	
■	■	■	
■ Damp	■ Ultra Low	■ 20	■ On/Off
Dry Level	Temp.	Time Dry	Signal

Dry Level

Use this button to select the dryness level for the cycle. Press the **Dry Level** button repeatedly to scroll through available settings.

- The appliance will automatically adjust the cycle time according to the selected dryness level. Selecting **More** or **Very** will increase the cycle time, while **Less** or **Damp** will decrease the cycle time.
- Use a **Less** or **Damp** setting for items that you wish to iron.

Temp.

Use this button to adjust the temperature setting. This allows precise care of fabrics and garments. Press the **Temp.** button repeatedly to scroll through available settings.

Time Dry

Use this button to manually select the drying time, from 20 to 60 minutes, in 10-minute increments.

- Use this for small loads or to remove wrinkles.
- Default **Temperature** is **High** and can be adjusted. The **Dry Level** cannot be adjusted.
- This option can be used together with the **Reduce Static** and **Wrinkle Care** options.
- Use the **More Time** / **Less Time** buttons to add or reduce the drying time in 5-minute increments.

Signal

The appliance plays a melody when the drying cycle is finished and the buttons make a sound when pressed.

Options and Extra Functions

Your dryer includes several additional cycle options to customize cycles to meet your individual needs.

Select the desired option after selecting the desired cycle and settings.

NOTE

- The LED for the option will light up when the option is selected.
- To protect your garments, not every option is available with every cycle.
- A chime will sound twice and the LED will not light up if the selected option is not allowed for the selected cycle.

TurboSteam

Use this function to add steam to a cycle. This function helps reduce wrinkles and odor in fabrics.

- 1 Turn on the dryer and turn the cycle selector knob to select the desired cycle.
- 2 Use the cycle modifier buttons to customize the settings for that cycle.
- 3 Press the **TurboSteam** button.

NOTE

- When this function is selected, the **Damp** and **Less** dry levels cannot be selected.

- 4 Press the **Start/Pause** button to start the cycle.

⚠ WARNING

- Do not touch the door during steam cycles. The door surface can become very hot.
- Do not attempt to reach into the dryer during a steam cycle. Steam can cause severe burns.

NOTE

- Steam may not be clearly visible during steam cycles. This is normal.
- Do not use steam with delicate fabrics such as wool, silk, or easily discolored fabrics.

- When the filter/duct is clogged, this option may not have optimal results.
- When this function is operating, the drum will stop to allow steam to stay in the drum.

Reduce Static

Use this function to add steam. This function injects steam late in the drying cycle to reduce the static electricity caused by dry fabrics rubbing together.

- 1 Turn on the dryer and turn the cycle selector knob to select the desired cycle.
- 2 Use the cycle modifier buttons to customize the settings for that cycle.
- 3 Press the **Reduce Static** button.

NOTE

- When this function is selected, the **Damp** and **Less** dry levels cannot be selected.

- 4 Press the **More Time** or **Less Time** buttons to adjust the steam time depending on the size of the load (7, 9, 11, 14, 16, or 18 items).
- 5 Press the **Start/Pause** button to start the cycle.

⚠ WARNING

- Do not touch the door during steam cycles. The door surface can become very hot.
- Do not attempt to reach into the dryer during a steam cycle. Steam can cause severe burns.

NOTE

- Steam may not be clearly visible during steam cycles. This is normal.
- Do not use steam with delicate fabrics such as wool, silk, or easily discolored fabrics.
- When the filter/duct is clogged, this option may not have optimal results.
- When this function is operating, the drum will stop to allow steam to stay in the drum.

Energy Saver

This option helps to reduce the energy consumption of the **Normal** cycle, depending on the load size. When the **Energy Saver** option is selected, the cycle begins with an air dry section and the drying time is increased.

NOTE

- The **Energy Saver** option is turned on by default in the **Normal** cycle.
 - Turning the **Energy Saver** option off changes the default cycle to the last cycle used. To return to the default settings, turn the **Energy Saver** option on.
-

More Time / Less Time

Use these buttons to increase or decrease drying time in 5 minute increments when you use manual drying cycles such as **Speed Dry**, **Air Dry** and **Time Dry**.

Wrinkle Care

Selecting this option will tumble the load periodically for up to 3 hours after the selected cycle, or until the door is opened. This is helpful in preventing wrinkles when you are unable to remove items from the dryer immediately.

Press the **Wrinkle Care** button before you start a drying cycle.

NOTE

- When the option is turned on, a rectangle with a dashed line and **End** appears on the display until the feature is off.
 - When the option is turned on, only the **Power** button works after the drying cycle ends.
 - To select the option after starting a cycle, pause the cycle, set the option, and press **Start/Pause**.
 - Always turn off the appliance before unloading the clothes.
-

Drum Light

The drum is equipped with a white LED light that illuminates when the dryer is turned on. This light automatically turns off when the door is closed and the cycle starts.

- Press and hold the **Wrinkle Care** button for 3 seconds during the cycle to turn on the drum light.
- The drum light will turn off automatically after 4 minutes.

Damp Dry Signal

When this option is selected, the appliance signals when the load is approximately 80% dry. This allows you to remove faster-drying lightweight items or items that you would like to iron or hang while they are still slightly damp.

Press the **Damp Dry Signal** button before you start a drying cycle.

Control Lock

Use this function to disable the controls. This function can prevent children from changing cycles or operating the dryer.

NOTE

- The function does not lock the door.
 - Once this function is set, all buttons are locked except the **Power** button.
 - When the controls are locked, **EL** and the remaining time are alternately shown on the display during the dry cycle.
 - Turning off the power will not reset this function. You must deactivate this function before you can access any other options and functions.
-

Locking/Unlocking the Control Panel

- 1 Turn on the power.
 - 2 Press and hold the **Damp Dry Signal** button for 3 seconds to activate/deactivate this function.
- When the function is deactivated, a chime will sound and the remaining time for the current cycle will reappear on the display.

SMART FUNCTIONS

LG ThinQ Application

The **LG ThinQ** application allows you to communicate with the appliance using a smartphone.

LG ThinQ Application Features

• **Dryer Cycle**

- Download new and specialized cycles that are not included in the standard cycles on the appliance. Appliances that have been successfully connected to the **LG ThinQ** application can download a variety of specialty cycles specific to the appliance. Once cycle download is completed in the appliance, the appliance keeps the downloaded cycle until a new cycle is downloaded.

NOTE

- Only one cycle can be stored on the appliance at a time.

• **Energy Monitoring**[†]

- This feature keeps track of how the dryer's power consumption is affected by selected drying cycles and options.

• **Remote Control**

- Control the appliance remotely or check to see how much time is left in the cycle from the **LG ThinQ** application.

NOTE

- Once the remote control feature is enabled, you can start a cycle from the **LG ThinQ** application. If the cycle is not started, the appliance will wait to start the cycle until the appliance is turned off remotely or the remote control feature is disabled.
- If the door is opened, the remote control feature is disabled.

• **Push Messages**

- When the cycle is complete or the appliance has problems, you will receive a push message.

• **Smart Diagnosis**[™]

- This function provides useful information for diagnosing and solving issues with the appliance based on the pattern of use.

• **Settings**

- Allows you to set various options on the appliance and in the application.

† This feature is only available on some models.

NOTE

- If you change your wireless router, Internet service provider, or password, delete the connected appliance from the **LG ThinQ** application and connect it again.
- This information is current at the time of publication. The application is subject to change for product improvement purposes without notice to users.

Installing LG ThinQ App and Connecting an LG Appliance

Models with QR Code

Scan the QR code attached to the product using the camera or a QR code reader app on your smartphone.

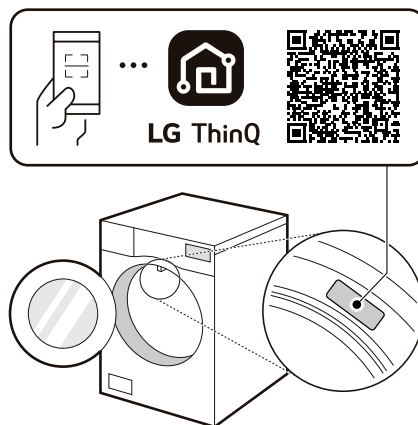

Models without QR Code

- 1 Search for and install the **LG ThinQ** app from the Google Play Store or Apple App Store on a smartphone.
- 2 Run the **LG ThinQ** app and sign in with your existing account or create an LG account to sign in.

- 3** Touch the add (+) button on the **LG ThinQ** app to connect your LG appliance. Follow the instructions in the app to complete the process.

NOTE

- You may be asked to provide a password to connect to the LG network (not your home network) during the Wi-Fi setup. The password is the last 4 characters of the network name, repeated twice, with no spaces. For example, if the network name appears as LG_XXXX_8b92, then you would enter 8b928b92 as your password. The password is case sensitive and the last 4 characters are unique to your appliance.
- To verify the Wi-Fi connection, check that the  icon on the control panel is lit.
- The appliance supports 2.4 GHz Wi-Fi networks only. To check your network frequency, contact your Internet service provider or refer to your wireless router manual.
- **LG ThinQ** is not responsible for any network connection problems or any faults, malfunctions, or errors caused by network connection.
- If the appliance is having trouble connecting to the Wi-Fi network, it may be too far from the router. Purchase a Wi-Fi repeater (range extender) to improve the Wi-Fi signal strength.
- The Wi-Fi connection may not connect or may be interrupted because of the home network environment.
- The network connection may not work properly depending on the Internet service provider.
- The surrounding wireless environment can make the wireless network service run slowly.
- If the appliance cannot be connected due to problems with the wireless signal transmission, unplug the appliance and wait about a minute before trying again.
- If the firewall on your wireless router is enabled, disable the firewall or add an exception to it.
- The wireless network name (SSID) should be a combination of English letters and numbers. (Do not use special characters.)
- Smartphone user interface (UI) may vary depending on the mobile operating system (OS) and the manufacturer.
- If the security protocol of the router is set to **WEP**, network setup may fail. Change the security protocol (**WPA2** is recommended) and connect the product again.

Using the Appliance Remotely

Remote Start

Use a smartphone to control the appliance remotely. You can also monitor the cycle operation so you know how much time is left in the cycle.

Using Remote Start

- 1** Put the laundry into the drum and close the dryer door.
- 2** Press the **Power** button.
- 3** Press and hold the **Remote Start** button for 3 seconds to enable the remote control function.
- 4** Start a cycle from the **LG ThinQ** application on your smartphone.

NOTE

- Once the function is enabled, you can only start a cycle from the **LG ThinQ** smartphone application. If the cycle is not started, the application will wait to start the cycle until it is turned off remotely from the application or this function is disabled.
- If the door has been opened, you cannot start a cycle remotely.

Disabling Remote Start Manually

When the function is activated, press and hold the **Remote Start** button for 3 seconds.

Download Cycle

You can download new and specialized cycles that are not included in the standard cycles on the appliance.

Appliances that have been successfully connected to a Wi-Fi network can download a variety of specialty cycles specific to the appliance.

Once cycle download is completed in the appliance, the product keeps the downloaded cycle until a new cycle is downloaded.

NOTE

- Only one downloaded cycle can be stored on the appliance at a time.

Wireless LAN Module Specifications

Frequency Range	2412 - 2462 MHz
Output Power (Max)	< 30 dBm

FCC Notice

The following notice covers the transmitter module contained in this product.

This equipment has been tested and found to comply with the limits for a Class B digital device, pursuant to Part 15 of the FCC Rules. These limits are designed to provide reasonable protection against harmful interference in a residential installation. This equipment generates, uses, and can radiate radio frequency energy and, if not installed and used in accordance with the instructions, may cause harmful interference to radio communications. However, there is no guarantee that interference will not occur in a particular installation. If this equipment does cause harmful interference to radio or television reception, which can be determined by turning the equipment off and on, the user is encouraged to try to correct the interference by one or more of the following measures:

- Reorient or relocate the receiving antenna.
- Increase the separation between the equipment and the receiver.
- Connect the equipment into an outlet on a circuit different from that to which the receiver is connected.
- Consult the dealer or an experienced radio/TV technician for help.

This device complies with part 15 of the FCC Rules. Operation is subject to the following two conditions:

- (1) This device may not cause harmful interference and
- (2) This device must accept any interference received, including interference that may cause undesired operation.

Any changes or modifications in construction of this device which are not expressly approved by the party responsible for compliance could void the user's authority to operate the equipment.

FCC RF Radiation Exposure Statement

This equipment complies with FCC radiation exposure limits set forth for an uncontrolled environment. This transmitter must not be co-located or operating in conjunction with any other antenna or transmitter.

This equipment should be installed and operated with a minimum distance of 20 cm (7.8 inches) between the antenna and your body. Users must follow the specific operating instructions for satisfying RF exposure compliance.

Open Source Software Notice Information

To obtain the source code that is contained in this product, under GPL, LGPL, MPL, and other open source licenses that have the obligation to disclose source code, and to access all referred license terms, copyright notices and other relevant documents, please visit <https://opensource.lge.com>.

LG Electronics will also provide open source code to you on CD-ROM for a charge covering the cost of performing such distribution (such as the cost of media, shipping, and handling) upon email request to opensource@lge.com.

This offer is valid to anyone in receipt of this information for a period of three years after our last shipment of this product.

Smart Diagnosis™ Function

Use this feature to help you diagnose and solve problems with your appliance.

NOTE

- For reasons not attributable to LGE's negligence, the service may not operate due to external factors such as, but not limited to, Wi-Fi unavailability, Wi-Fi disconnection, local app store policy, or app unavailability.
- The feature may be subject to change without prior notice and may have a different form depending on where you are located.

Using LG ThinQ to Diagnose Issues

If you experience a problem with your Wi-Fi equipped appliance, it can transmit troubleshooting data to a smartphone using the **LG ThinQ** application.

- Launch the **LG ThinQ** application and select the **Smart Diagnosis** feature in the menu. Follow the instructions provided in the **LG ThinQ** application.

Using Audible Diagnosis to Diagnose Issues

Follow the instructions below to use the audible diagnosis method.

- Launch the **LG ThinQ** application and select the **Smart Diagnosis** feature in the menu. Follow the instructions for audible diagnosis provided in the **LG ThinQ** application.

- 1** Press the **Power** button to turn on the appliance.
 - Do not press any other buttons.
- 2** Hold the mouthpiece of your phone in front of the **Power** button.

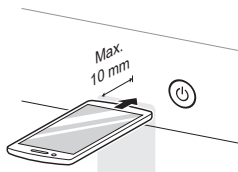

- 3** Press and hold the **Temp.** button for 3 seconds or longer while continuing to hold your phone to the **Power** button.
- 4** Keep the phone in place until the tone transmission has finished. Once the tones have stopped, the diagnosis will be displayed in the application.

NOTE

- For best results, do not move the phone while the tones are being transmitted.
-

MAINTENANCE

⚠ WARNING

- Unplug the appliance before cleaning.
- Never use harsh chemicals, abrasive cleaners, or solvents to clean the appliance. They will damage the finish.

Regular Cleaning

Cleaning the Exterior

Proper care of your appliance can extend its life. The outside of the appliance can be cleaned with warm water and a mild, nonabrasive household detergent. Immediately wipe off any spills with a soft, damp cloth.

NOTE

- Do not use methylated spirits, solvents, or similar products.
- Never use steel wool or abrasive cleansers; they can damage the surface.

Cleaning the Interior

Wipe around the door opening and seal with a soft, damp cloth to prevent lint and dust buildup that could damage the door seal.

Clean the window with a soft cloth dampened with warm water and a mild, nonabrasive household detergent. Then wipe dry.

The stainless steel drum can be cleaned with a conventional stainless steel cleaner, used according to the manufacturer's specifications. Never use steel wool or abrasive cleansers; they may scratch or damage the surface.

Cleaning Around and Under the Appliance

Vacuum lint and dust from around the dryer and underneath it regularly.

Maintaining Ductwork

Vent ductwork should be checked for lint buildup once per month and cleaned at least once per year. If any noticeable reduction in airflow or drying performance occurs, immediately check ductwork for obstructions and blockages and contact a qualified technician or service provider.

Cleaning the Lint Filter

Always clean the lint from the filter after every cycle.

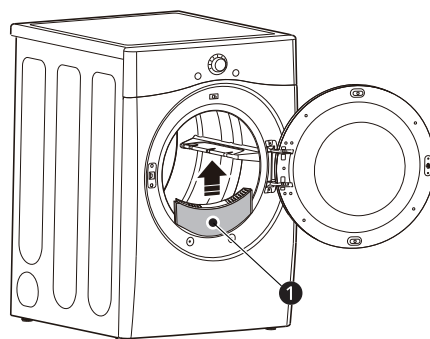

1 Lint Filter

To clean the lint filter, open the dryer door and pull the lint filter straight up. Then:

- 1 For everyday cleaning, roll any lint off the filter with your fingers, or

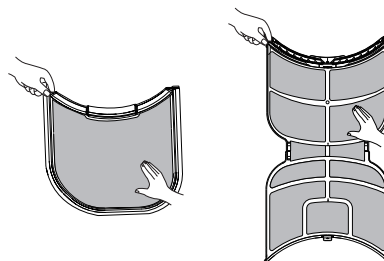

- 2 Vacuum the lint filter.

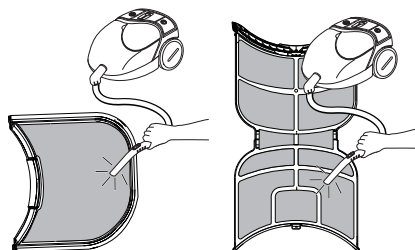

- 3** If the lint filter has become very dirty or clogged with fabric softener, wash the lint filter in warm, soapy water and allow it to dry thoroughly before reinstalling.

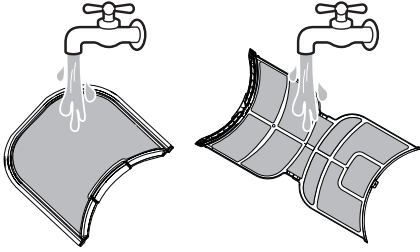

NOTE

- NEVER operate the appliance without the lint filter in place.
-

TROUBLESHOOTING

FAQs

Frequently Asked Questions

Q: When I press a button, why does my dryer beep and then nothing happens?

A: The Control Lock feature is turned on. To turn off Control Lock, turn the dryer on and press and hold the button that has **Control Lock** on or under it for 3 seconds.

Q: Why does my dryer take so long to dry clothes?

A: Proper airflow is critical to the efficient operation of clothes dryers. A lint filter which is full of lint or clogged with fabric softener sheet residue can reduce the airflow to the point that the time required to dry clothing will be greatly increased. For more tips, see the troubleshooting charts.

Q: Why does my dryer start by itself every few minutes?

A: This is how the Wrinkle Care feature works. The dryer runs briefly every few minutes for up to 3 hours after the cycle finishes. This feature is designed to help prevent wrinkles from setting in when the dryer is not unloaded immediately after the cycle is finished.

Q: Why does my dryer show 3 minutes when I select the Steam Fresh™ cycle?

A: When the Steam Fresh™ cycle is selected, the dryer displays the recommended number of garments for the cycle, not the estimated cycle time, until the cycle is started. Use the **More Time** or **Less Time** buttons to adjust the load size setting for the number of garments you desire. For a large load or single bulky item use the **Big** (big) setting.

User Support Videos

For further assistance, there are videos and tutorials available through the lg.com website.

Scan this QR code to quickly access the video search page on the official LG website.



- 1** On the lg.com/us home page, click on the **Support** menu tab to bring up the menu selections. Select **Video Tutorials**.
- 2** Type **Dryer** in the search box on the new page and click the **Search** button.

Before Calling for Service

The dryer is equipped with an automatic error-monitoring system to detect and diagnose problems at an early stage. If the dryer does not function properly or does not function at all, check the following before you call for service.

Error Messages

Problem	Possible Cause & Solution
EE 1 through EE 7	Temperature sensor failure. <ul style="list-style-type: none"> Turn off the appliance and call for service.
P5	Power cord is connected incorrectly. <ul style="list-style-type: none"> Check the connection of the power cord to the terminal block.
d80, d90, d95	Exhaust system is too long or has too many turns/restrictions. <ul style="list-style-type: none"> Do not use the appliance until the exhaust system has been cleaned and/or repaired. Using the appliance with severely restricted exhaust is dangerous and could result in a fire or other property damage. Check the outside dryer vent while the appliance is operating to make sure there is strong airflow. If the exhaust system is extremely long, have it repaired or rerouted. House exhaust system blocked. <ul style="list-style-type: none"> Keep the area around the dryer clean and free of clutter. Check vent hood for damage or lint clogging. Make sure the area around the vent hood is clear.
The display shows bl 9	More Time button was pressed. <ul style="list-style-type: none"> This display indicates that the steam option has been set for a "big" item such as a comforter. Press the Less Time button to reduce the indicated load size.

Operation

Problem	Possible Cause & Solution
Flow Sense™ indicator shows four bars during the drying cycle.	Exhaust system is too long or has too many turns/restrictions. <ul style="list-style-type: none"> Install a shorter or straighter duct run. See the Installation instructions for details.
	Partial blockage of the ductwork due to lint buildup or other foreign object. <ul style="list-style-type: none"> Ductwork should be checked/cleaned immediately. The appliance can be used in this condition, but drying times will be longer and energy consumption will increase.
	The appliance has detected a restriction in the external dryer venting. <ul style="list-style-type: none"> If exhaust restrictions are sensed by the Flow Sense™ system, the indicator will remain on for 2 hours after the end of the cycle. Opening the door or pressing the Power button will turn off the display.
The Flow Sense™ indicator remains active after clearing the restriction in the venting.	After clearing the restrictions, the Flow Sense™ system requires multiple, consecutive cycles to determine that the performance value has improved before the Flow Sense™ indicator is reset. <ul style="list-style-type: none"> If the Flow Sense™ indicator remains active for more than five cycles after the restriction has been cleared, call for service.
The appliance will not turn on.	Power cord is not properly plugged in. <ul style="list-style-type: none"> Make sure that the power plug is securely plugged into a grounded outlet matching the appliance's rating plate.

Problem	Possible Cause & Solution
The appliance will not turn on.	<p>House fuse is blown, circuit breaker has tripped, or power outage has occurred.</p> <ul style="list-style-type: none"> Reset circuit breaker or replace fuse. Do not increase fuse capacity. If the problem is a circuit overload, have it corrected by a qualified electrician.
The appliance does not heat.	<p>House fuse is blown, circuit breaker has tripped, or power outage has occurred.</p> <ul style="list-style-type: none"> Reset circuit breaker or replace fuse. Do not increase fuse capacity. If the problem is a circuit overload, have it corrected by a qualified electrician.
	<p>Gas supply or service is turned off.</p> <ul style="list-style-type: none"> Confirm that the hose gas shutoff and the shutoff valves of the dryer are both fully open. Even if gas is not supplied to the appliance, it will run and no error codes will display. Verify that other gas appliances in the home are working normally.
	<p>Energy Saver option is selected.</p> <ul style="list-style-type: none"> If using Normal cycle, deselect the energy saver option that is selected by default. This option reduces energy use by adding an air dry section to the beginning of the cycle. It is normal to feel no heat at the beginning of the cycle while in Energy Saver mode.
Clothes take too long to dry.	<p>Exhaust ducts are blocked, dirty, or duct run is too long.</p> <ul style="list-style-type: none"> Confirm that the exhaust duct is properly configured and free of debris, lint, and obstructions. Make sure that the outside wall damper can open properly and is not blocked, jammed, or damaged.
	<p>Load is not properly sorted.</p> <ul style="list-style-type: none"> Separate heavy items from lightweight items. Larger and heavier items take longer to dry. Light items in a load with heavy items can fool the sensor because the light items dry faster.
	<p>Large and heavy fabrics are loaded.</p> <ul style="list-style-type: none"> Heavy fabrics take longer to dry because they tend to retain more moisture. To help reduce and maintain more consistent drying times for large and heavy fabrics, separate these items into smaller loads of a consistent size.
	<p>Dryer controls are not set properly.</p> <ul style="list-style-type: none"> Use the appropriate control settings for the type of load you are drying. Some loads may require an adjustment of the dry level setting for proper drying.
	<p>Lint filter needs to be cleaned.</p> <ul style="list-style-type: none"> Remove the lint from the filter before every load. With the lint removed, hold the filter up to a light to see if it is dirty or clogged. With some loads that produce high amounts of lint, such as new bath towels, it may be necessary to pause the cycle and clean the filter during the cycle.
	<p>House fuse is blown, circuit breaker has tripped, or power outage has occurred.</p> <ul style="list-style-type: none"> Reset circuit breaker or replace fuse. Do not increase fuse capacity. If the problem is a circuit overload, have it corrected by a qualified electrician.
	<p>The appliance is overloaded.</p> <ul style="list-style-type: none"> Divide extra large loads into smaller loads for better drying performance and efficiency.
	<p>The appliance is underloaded.</p> <ul style="list-style-type: none"> If you are drying a very small load, add a few extra items to ensure proper tumble action. If the load is small and you are using SENSOR DRY cycles, the electronic control cannot properly sense the dryness of the load and may shut off too soon. Use MANUAL DRY cycles or add some extra wet clothes to the load.
	<p>Energy Saver option is selected. (on some models)</p> <ul style="list-style-type: none"> If using Normal cycle, deselect the energy saver option that is selected by default. This option reduces energy use by adding an air dry section to the beginning of the cycle. It is normal to feel no heat at the beginning of the cycle while in Energy Saver mode.

Problem	Possible Cause & Solution
Drying time is not consistent.	<p>Heat settings, load size, or dampness of clothing is not consistent.</p> <ul style="list-style-type: none"> The drying time for a load will vary depending on the size of the load, the type of fabrics, the wetness of the clothes and the condition of the lint filter. Even an unbalanced load in the washer can cause poor spinning, resulting in wetter clothes which will take longer to dry.

Performance

Problem	Possible Cause & Solution
Clothes are wrinkled.	<p>Clothes dried too long (overdried).</p> <ul style="list-style-type: none"> Overdrying a load of laundry can lead to wrinkled clothes. Try a shorter drying time or use a lower dry level setting and remove items while they still retain a slight amount of moisture.
	<p>Clothes left in dryer too long after cycle ends.</p> <ul style="list-style-type: none"> Use the Wrinkle Care option. This option will tumble the clothes briefly every few minutes for up to 3 hours to help prevent wrinkling.
Greasy or dirty spots on clothes.	<p>Fabric softener used incorrectly.</p> <ul style="list-style-type: none"> Check and follow the instructions provided with your fabric softener.
	<p>Clean and dirty clothes are being dried together.</p> <ul style="list-style-type: none"> Use your dryer to dry only clean items. Soil from dirty clothes can transfer to the clean clothes in the same or later loads.
	<p>Clothes were not properly cleaned or rinsed before being placed in the dryer.</p> <ul style="list-style-type: none"> Stains on dried clothes could be stains that were not removed during the washing process. Make sure that clothes are being completely cleaned or rinsed according to the instructions for your washer and detergent. Some difficult soils may require pre-treating prior to washing.
Clothes are shrinking.	<p>Garment care instructions are not being followed.</p> <ul style="list-style-type: none"> To avoid shrinking your clothes, always consult and follow fabric care instructions. Some fabrics will naturally shrink when washed. Other fabrics can be washed but will shrink when dried in a dryer. Use a low or no heat setting.
Lint on clothes.	<p>Lint filter not cleaned properly.</p> <ul style="list-style-type: none"> Remove the lint from the filter before every load. With the lint removed, hold the filter up to a light to see if it is dirty or clogged. If it looks dirty, follow the cleaning instructions in the MAINTENANCE section. With some loads that produce high amounts of lint, it may be necessary to clean the filter during the cycle.
	<p>Laundry not sorted properly.</p> <ul style="list-style-type: none"> Some fabrics are lint producers (i.e., a fuzzy white cotton towel) and should be dried separately from clothes that are lint trappers (i.e., a pair of black linen pants).
	<p>Excess static in clothes.</p> <ul style="list-style-type: none"> Use a fabric softener to reduce static electricity. Be sure to follow the manufacturer's instructions. Overdrying a load of laundry can cause a buildup of static electricity. Adjust settings and use a shorter drying time, or use Sensor Dry cycles.
	<p>The appliance is overloaded.</p> <ul style="list-style-type: none"> Divide extra large loads into smaller loads for drying.
	<p>Tissue, paper, etc., left in pockets.</p> <ul style="list-style-type: none"> Check pockets thoroughly before washing and drying clothes.

Problem	Possible Cause & Solution
Excess static in clothes after drying.	Fabric softener is not used or is used incorrectly. <ul style="list-style-type: none"> Use a fabric softener or the Reduce Static option, if available, to reduce static electricity. Be sure to follow the manufacturer's instructions.
	Clothes dried too long (overdried). <ul style="list-style-type: none"> Overdrying a load of laundry can cause a buildup of static electricity. Adjust settings and use a shorter drying time, or use Manual Dry cycles. Select a lower dry level setting on Sensor Dry cycles, if necessary.
	Drying synthetics, permanent press, or synthetic blends. <ul style="list-style-type: none"> These fabrics are naturally more prone to static buildup. Try using fabric softener, or use a lower dry level setting and/or shorter time settings for Manual Dry cycles.
Clothes have damp spots after a Sensor Dry cycle.	Very large load or very small load. Single large item such as a blanket or comforter. <ul style="list-style-type: none"> If items are too tightly packed or too sparse the sensor may have trouble reading the dryness level of the load. Use a Time Dry cycle for very small loads. Large, bulky items such as blankets or comforters can sometimes wrap themselves into a tight ball of fabric. The outside layers will dry and register on the sensors, while the inner core remains damp. When drying a single bulky item, it may help to pause the cycle once or twice and rearrange the item to unwrap and expose any damp areas. To dry a few remaining damp items from a very large load or a few damp spots on a large item after a sensor cycle has completed, empty the lint trap, and then set a Time Dry cycle to finish drying the item(s).

Steam Functions

Problem	Possible Cause & Solution
Water drips from nozzle when Steam Cycle starts.	This is normal. <ul style="list-style-type: none"> This is steam condensation. The dripping water will stop after a short time.
Garments still wrinkled after Steam Fresh™.	Too many or overly different types of garments in dryer. <ul style="list-style-type: none"> Small loads of 1 to 5 items work best. Load fewer garments. Load similar types of garments.
Creases or pleats are gone from garments after Steam Fresh™.	The function of this cycle is to remove wrinkles from fabric. <ul style="list-style-type: none"> Use an iron to replace creases and pleats in garments.
Garments have static after using the Reduce Static option.	This is normal. <ul style="list-style-type: none"> The amount of static experienced will depend on the individual moisture level in the skin.
Garments are too damp or too dry after using the Reduce Static option.	Correct drying options not selected. <ul style="list-style-type: none"> Select the load weight manually before starting the Reduce Static option.
Steam does not generate, but no error code is shown.	Water level error. <ul style="list-style-type: none"> Unplug dryer and call for service.
Water drips from door during Steam Cycle.	This is normal. <ul style="list-style-type: none"> Condensation will normally form on the inside of the dryer door during steam operation. Some condensation may drip out the bottom of the door.
Steam is not visible during Steam Cycle.	This is normal. <ul style="list-style-type: none"> Steam vapor is difficult to see when the door is closed. However, condensation will normally form on the inside of the dryer door if the steam system is operating normally.

Problem	Possible Cause & Solution
Drum does not turn during Steam Cycle.	<p>This is normal.</p> <ul style="list-style-type: none"> The drum is turned off so that the steam vapor remains in the drum. The drum will normally turn for about 2 seconds once a minute.
Cannot see steam vapor at the beginning of cycle.	<p>This is normal.</p> <ul style="list-style-type: none"> Steam is released at different stages of the cycle for each option.
Odors remain in clothing after Steam Fresh™.	<p>Steam Fresh™ did not remove odor completely.</p> <ul style="list-style-type: none"> Fabrics containing strong odors should be washed in a normal cycle.

Odors

Problem	Possible Cause & Solution
The appliance has an unpleasant odor.	<p>Are you using the appliance for the first time?</p> <ul style="list-style-type: none"> The odor is caused by the rubber material inside the appliance. The odor is normal when the appliance is new and disappears after you run several cycles.
	<p>Do you smell an odor during use?</p> <ul style="list-style-type: none"> Do not exceed the manufacturer's recommended amount of detergent when washing clothes. Excess detergent can build up on clothing and cause odors. Leaving clothes in the washer or dryer after the cycle ends can lead to odors. Unload clothing promptly when the cycle ends. Keep lint filters clean. Clogged or dirty lint filters can cause odors. After cleaning the lint filter, allow it to dry completely before using it.

Wi-Fi

Problem	Possible Cause & Solution
Trouble connecting appliance and smartphone to Wi-Fi network.	<p>The password for the Wi-Fi network was entered incorrectly.</p> <ul style="list-style-type: none"> Delete your home Wi-Fi network and begin the connection process again.
	<p>Mobile data for your smartphone is turned on.</p> <ul style="list-style-type: none"> Turn off the Mobile data on your smartphone before connecting the appliance.
	<p>The wireless network name (SSID) is set incorrectly.</p> <ul style="list-style-type: none"> The wireless network name (SSID) should be a combination of English letters and numbers. (Do not use special characters.)
	<p>The router frequency is not 2.4 GHz.</p> <ul style="list-style-type: none"> Only a 2.4 GHz router frequency is supported. Set the wireless router to 2.4 GHz and connect the appliance to the wireless router. To check the router frequency, check with your Internet service provider or the router manufacturer.
	<p>The appliance and the router are too far apart.</p> <ul style="list-style-type: none"> If the appliance is too far from the router, the signal may be weak and the connection may not be configured correctly. Move the router closer to the appliance or purchase and install a Wi-Fi repeater.

Problem	Possible Cause & Solution
Trouble connecting appliance and smartphone to Wi-Fi network.	<p>During Wi-Fi setup, the app is requesting a password to connect to the product (on certain phones).</p> <ul style="list-style-type: none">• Locate the network name which starts with "LG" under Settings > Networks. Note the last part of the network name.<ul style="list-style-type: none">- If the network name looks like LGE_Appliance_XX-XX-XX, enter lge12345.- If the network name looks like LGE_Appliance_XXXX, enter XXXX twice as your password. For example, if the network name appears as LGE_Appliance_8b92, then you would enter 8b928b92 as your password. In this instance, the password is case sensitive and the last 4 characters are unique to your appliance.

LIMITED WARRANTY

USA

TERMS AND CONDITIONS

ARBITRATION NOTICE: THIS LIMITED WARRANTY CONTAINS AN ARBITRATION PROVISION THAT REQUIRES YOU AND LG ELECTRONICS (“LG”) TO RESOLVE DISPUTES BY BINDING ARBITRATION INSTEAD OF IN COURT, UNLESS YOU CHOOSE TO OPT OUT. IN ARBITRATION, CLASS ACTIONS AND JURY TRIALS ARE NOT PERMITTED. PLEASE SEE THE SECTION TITLED “PROCEDURE FOR RESOLVING DISPUTES” BELOW.

Should your LG Dryer (“Product”) fail due to a defect in materials or workmanship under normal and proper use, during the warranty period set forth below, LG will, at its option, repair or replace the Product. This limited warranty is valid only to the original retail purchaser of the Product (“You”) and applies only when purchased lawfully and used within the United States including U.S. Territories.

WARRANTY PERIOD		
Period	Scope of Warranty	HOW SERVICE IS HANDLED
One (1) year from date of original retail purchase	Parts and Labor	LG will provide parts and labor to repair or replace defective parts.
Three (3) years from date of original retail purchase	Dryer drum	Parts only. Customer will be responsible for any labor or in-home service to replace defective parts.

- Replacement Products and parts are warranted for the remaining portion of the original warranty period or ninety (90) days, whichever is greater.
- Replacement Products and parts may be new, reconditioned, refurbished, or otherwise factory remanufactured.
- Replaced Product or part(s) will be the property of LG.
- Proof of original retail purchase specifying the Product model and date of purchase is required to obtain warranty service under this limited warranty.

EXCEPT TO THE EXTENT PROHIBITED BY APPLICABLE LAW, ANY IMPLIED WARRANTY OF MERCHANTABILITY OR FITNESS FOR A PARTICULAR PURPOSE ON THE PRODUCT IS LIMITED IN DURATION TO THE DURATION OF THE ABOVE LIMITED WARRANTY. UNDER NO CIRCUMSTANCES SHALL LG OR ITS U.S. DISTRIBUTORS/DEALERS BE LIABLE FOR ANY INDIRECT, INCIDENTAL, CONSEQUENTIAL, SPECIAL, OR PUNITIVE DAMAGES, INCLUDING, WITHOUT LIMITATION, LOST GOODWILL, LOST REVENUES OR PROFITS, WORK STOPPAGE, IMPAIRMENT OF OTHER GOODS, COST OF REMOVAL AND REINSTALLATION OF THE PRODUCT, LOSS OF USE, OR ANY OTHER DAMAGES WHETHER BASED IN CONTRACT, TORT, OR OTHERWISE. LG’S TOTAL LIABILITY, IF ANY, SHALL NOT EXCEED THE PURCHASE PRICE PAID BY YOU FOR THE PRODUCT.

SOME STATES DO NOT ALLOW THE EXCLUSION OR LIMITATION OF INCIDENTAL OR CONSEQUENTIAL DAMAGES OR LIMITATIONS ON HOW LONG AN IMPLIED WARRANTY LASTS, SO THE ABOVE EXCLUSIONS OR LIMITATIONS MAY NOT APPLY TO YOU. THIS LIMITED WARRANTY GIVES YOU SPECIFIC LEGAL RIGHTS AND YOU MAY ALSO HAVE OTHER RIGHTS THAT VARY FROM STATE TO STATE.

THIS LIMITED WARRANTY DOES NOT COVER:

- Service trips to deliver, pick up, or install, educate how to operate, correct wiring, or correct unauthorized repairs.
- Damage or failure of the Product to perform during power failures and interrupted or inadequate electrical service.
- Damage or failure of the Product caused by leaky or broken water pipes, frozen water pipes, restricted drain lines, inadequate or interrupted water supply or inadequate supply of air.

- Damage or failure of the Product resulting from operating the Product in a corrosive atmosphere or contrary to the Product owner's manual.
- Damage or failure of the Product caused by accidents, pests and vermin, lightning, wind, fire, floods, acts of nature, or any other causes beyond the control of LG.
- Damage or failure of the Product caused by unauthorized modification or alteration, or if the Product is used for other than the intended purpose, or any water leakage where the Product was not properly installed.
- Damage or failure of the Product caused by incorrect electrical current, voltage, or plumbing codes.
- Damage or failure of the Product caused by transportation, storage, and/or handling, including scratches, dents, chips, and/or other damage to the finish of the Product, unless such damage is reported within one (1) week of delivery.
- Damage or failure of the Product resulting from misuse, abuse, improper installation, repair, or maintenance. Improper repair includes the use of parts not authorized by LG. Improper installation or maintenance includes installation or maintenance contrary to the Product owner's manual.
- Damage or failure of the Product caused by the use of parts, components, accessories, consumable cleaning products, or any other products or services that were not authorized by LG.
- Damage or missing items to any display or open box Product.
- Refurbished Product or any Product sold "As Is", "Where Is", "With all Faults", or similar disclaimer.
- Products with original serial numbers that have been removed, altered, or cannot be readily determined.
- Increases in utility costs and additional utility expenses.
- Any noises associated with normal operation.
- Products used for other than normal and proper household use (e.g., commercial or industrial use) or contrary to the Product owner's manual.
- Costs associated with removal and reinstallation of the Product for repairs, or the removal and reinstallation of the Product if it is installed in an inaccessible location or not installed in accordance with the Product Owner's manual.
- Accessories, removable components, or consumable parts (e.g. Shelves, door bins, drawers, water/air filters, racks, light bulbs, batteries, etc., as applicable), except for internal/functional parts covered under this limited warranty.
- Conversion of product from natural gas or LP gas.

The cost of repair or replacement under these excluded circumstances shall be borne by You.

TO OBTAIN WARRANTY SERVICE AND ADDITIONAL INFORMATION

Call 1-800-243-0000 and select the appropriate option from the menu.

Or visit our website at <http://www.lg.com>

Or by mail: LG Electronics Customer Service P.O. Box 240007 Huntsville, AL 35813 ATTN: CIC

PROCEDURE FOR RESOLVING DISPUTES:

ALL DISPUTES BETWEEN YOU AND LG ARISING OUT OF OR RELATING IN ANY WAY TO THIS LIMITED WARRANTY OR THE PRODUCT SHALL BE RESOLVED EXCLUSIVELY THROUGH BINDING ARBITRATION, AND NOT IN A COURT OF GENERAL JURISDICTION. BINDING ARBITRATION MEANS THAT YOU AND LG ARE EACH WAIVING THE RIGHT TO A JURY TRIAL AND TO BRING OR PARTICIPATE IN A CLASS ACTION.

Definitions. For the purposes of this section, references to "LG" mean LG Electronics U.S.A., Inc., its parents, subsidiaries and affiliates, and each of their officers, directors, employees, agents, beneficiaries, predecessors in interest, successors, assigns and suppliers; references to "dispute" or "claim" shall include any dispute, claim or controversy of any kind whatsoever (whether based in contract, tort, statute, regulation, ordinance, fraud, misrepresentation or any other legal or equitable theory) arising out of or relating in any way to the sale, condition or performance of the product or this Limited Warranty.

Notice of Dispute. In the event you intend to commence an arbitration proceeding, you must first notify LG in writing at least 30 days in advance of initiating the arbitration by sending a letter to LG at LG Electronics USA, Inc. Attn: Legal Department- Arbitration 111 Sylvan Avenue, Englewood Cliffs, NJ 07632.

You and LG agree to engage in good faith discussions in an attempt to amicably resolve your claim. The notice must provide your name, address, and telephone number; identify the product that is the subject of the claim; and describe the nature of the claim and the relief being sought. If you and LG are unable to resolve the dispute within 30 days, either party may proceed to file a claim for arbitration.

Agreement to Binding Arbitration and Class Action Waiver. Upon failure to resolve the dispute during the 30 day period after sending written notice to LG, you and LG agree to resolve any claims between us only by binding arbitration on an individual basis, unless you opt out as provided below. Any dispute between you and LG shall not be combined or consolidated with a dispute involving any other person's or entity's product or claim. More specifically, without limitation of the foregoing, any dispute between you and LG shall not under any circumstances proceed as part of a class or representative action. Instead of arbitration, either party may bring an individual action in small claims court, but that small claims court action may not be brought on a class or representative basis.

Arbitration Rules and Procedures. To begin arbitration of a claim, either you or LG must make a written demand for arbitration. The arbitration will be administered by the American Arbitration Association ("AAA") and will be conducted before a single arbitrator under the AAA's Consumer Arbitration Rules that are in effect at the time the arbitration is initiated (referred to as the "AAA Rules") and under the procedures set forth in this section. The AAA Rules are available online at www.adr.org/consumer. Send a copy of your written demand for arbitration, as well as a copy of this provision, to the AAA in the manner described in the AAA Rules. You must also send a copy of your written demand to LG at LG Electronics USA, Inc. Attn: Legal Department- Arbitration 111 Sylvan Avenue, Englewood Cliffs, NJ 07632. If there is a conflict between the AAA Rules and the rules set forth in this section, the rules set forth in this section will govern. This arbitration provision is governed by the Federal Arbitration Act. Judgment may be entered on the arbitrator's award in any court of competent jurisdiction. All issues are for the arbitrator to decide, except that issues relating to the scope and enforceability of the arbitration provision and to the arbitrability of the dispute are for the court to decide. The arbitrator is bound by the terms of this provision.

Governing Law. The law of the state of your residence shall govern this Limited Warranty and any disputes between us except to the extent that such law is preempted by or inconsistent with applicable federal law.

Fees/Costs. You do not need to pay any fee to begin an arbitration. Upon receipt of your written demand for arbitration, LG will promptly pay all arbitration filing fees to the AAA unless you seek more than \$25,000 in damages, in which case the payment of these fees will be governed by the AAA Rules. Except as otherwise provided for herein, LG will pay all AAA filing, administration and arbitrator fees for any arbitration initiated in accordance with the AAA Rules and this arbitration provision. If you prevail in the arbitration, LG will pay your attorneys' fees and expenses as long as they are reasonable, by considering factors including, but not limited to, the purchase amount and claim amount. Notwithstanding the foregoing, if applicable law allows for an award of reasonable attorneys' fees and expenses, an arbitrator can award them to the same extent that a court would. If the arbitrator finds either the substance of your claim or the relief sought in the demand is frivolous or brought for an improper purpose (as measured by the standards set forth in Federal Rule of Civil Procedure 11(b)), then the payment of all arbitration fees will be governed by the AAA Rules. In such a situation, you agree to reimburse LG for all monies previously disbursed by it that are otherwise your obligation to pay under the AAA Rules. Except as otherwise provided for, LG waives any rights it may have to seek attorneys' fees and expenses from you if LG prevails in the arbitration.

Hearings and Location. If your claim is for \$25,000 or less, you may choose to have the arbitration conducted solely on the basis of (1) documents submitted to the arbitrator, (2) through a telephonic hearing, or (3) by an in-person hearing as established by the AAA Rules. If your claim exceeds \$25,000, the right to a hearing will be determined by the AAA Rules. Any in-person arbitration hearings will be held at a location within the federal judicial district in which you reside unless we both agree to another location or we agree to a telephonic arbitration.

Opt Out. You may opt out of this dispute resolution procedure. If you opt out, neither you nor LG can require the other to participate in an arbitration proceeding. To opt out, you must send notice to LG no later than 30 calendar days from the date of the first consumer purchaser's purchase of the product by either: (i) sending an e-mail to optout@lge.com, with the subject line: "Arbitration Opt Out" or (ii) calling 1-800-980-2973. You must include in the opt out e-mail or provide by telephone: (a) your name and address; (b) the date on which the product was purchased; (c) the product model name or model number; and (d) the serial number (the serial number can be found (i) on the product; or (ii) online by accessing <https://>

www.lg.com/us/support/repair-service/schedule-repair-continued and clicking on “Find My Model & Serial Number”).

You may only opt out of the dispute resolution procedure in the manner described above (that is, by e-mail or telephone); no other form of notice will be effective to opt out of this dispute resolution procedure. Opting out of this dispute resolution procedure will not affect the coverage of the Limited Warranty in any way, and you will continue to enjoy the full benefits of the Limited Warranty. If you keep this product and do not opt out, then you accept all terms and conditions of the arbitration provision described above.



LG

Life's Good

LG Customer Information Center

For inquiries or comments,
visit **www.lg.com** or call:

1-800-243-0000 U.S.A.

1-888-542-2623 CANADA

Register your product Online!

www.lg.com