



brightspace™ interior • customcool™ technology • 2003 product specifications • turbocool™ setting • tall lighttouch! dispenser

# *GE Profile™* and *GE®* Refrigerators

**The Ultimate in Refrigeration.™**  
Rethought. Reinvented. Revolutionized.



***We bring good things to life.***

# The Ultimate in Refrigeration.™

GE Profile Arctica™ refrigerators bring a breath of fresh air to your kitchen and your life. The stylish exterior makes a dramatic statement, and the multilevel interior makes versatile use of every inch of storage space. In the fresh food compartment, slide-out shelves simplify loading and unloading. In the freezer compartment, the ice system is uniquely designed to allow more room for more food. In addition to innovative storage features, both compartments offer a range of cooling capabilities for the ultimate in flexibility and performance.



## CustomCool™ technology

Exclusive CustomCool technology gives you the ability to chill and thaw much faster than ever before possible. It also lets you select just-right temperatures for a variety of fresh foods.



## ClimateKeeper™ system

Exclusive ClimateKeeper system helps preserve refrigerator contents by providing consistent cooling.



## Contoured style

Arctica's clean contours and lines are perfectly compatible with any kitchen setting.



## Integrated Ice™ system

The icemaker and ice bucket are integrated in the freezer cabinet, not the freezer door, to free up valuable storage space. The bucket pulls out and down, providing easy access to cubed ice.

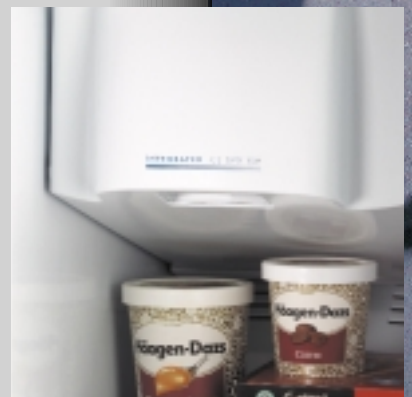



*GE Profile Arctica refrigerators offer exclusive cooling capabilities, dramatic styling and flexible features.*

# GE Profile Arctica™ Side-By-Side Refrigerators

## Specialized settings let you customize cooling for a variety of foods.

GE Profile Arctica side-by-side refrigerators include a number of high-performance capabilities. Perhaps the most notable is our exclusive CustomCool™ technology. A fresh take on cooling, this bottom pan feature offers three settings for different lifestyle needs:

**ExpressChill™** setting chills foods and beverages in minutes, not hours.

**ExpressThaw™** setting thaws meats and other freezer items in hours, not days.

**SelectTemp™** setting allows you to select just-right temperatures for specific foods.

Using these specialized settings, you are able to avoid the last-minute rush and simply relax. Whether the occasion calls for impromptu hors d'oeuvres for 20 or filet mignon for two, CustomCool takes care of everything.



It chills!



It thaws!



It preserves!



It fully extends!



*Multiple storage levels and options mean increased flexibility and convenience.*

# GE Profile Arctica™ Side-By-Side Models featuring CustomCool™ technology

**These models include** • Contoured doors • ClimateKeeper™ system • TurboCool™ setting • Upfront electronic touch temperature controls • Digital temperature display • CustomCool technology with full-extension drawer • FrostGuard™ technology • In-the-door beverage rack • Integrated Ice™ system • SmartWater™ Plus filtration system • Quick Ice™ feature • Water filter indicator light • LightTouch! tall dispenser with child lock and door alarm • Premium quiet design • Integrated shelf support system • QuickSpace™ shelf • Two slide-out, spillproof glass shelves • ClearLook™ adjustable door bins • Gallon door storage • Slide 'n Store™ full-extension freezer basket • Slide 'n Store freezer basket • Tilt-out wire freezer door bins • Contoured Profile handles • Tri-level lighting • NeverClean™ condenser **Note: bold = feature upgrade from previous model**



Beverage rack is conveniently located inside the refrigerator door to increase flexibility and free up valuable shelf space.

**ONLY GE HAS IT!**

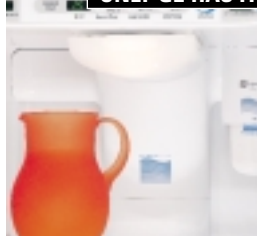

ClimateKeeper system combines a multifold air system, electronic sensors and electronic touch controls to keep temperatures consistent and help preserve refrigerator contents.

**ONLY GE HAS IT!**



Tall LightTouch! dispenser fills sport bottles, pitchers, even blenders! Delivers chilled filtered water, crushed or cubed ice.



Refreshment center provides easy access to frequently used items.

Not all features available on all models.



## GE Profile™ Refreshment Center and Dispenser Models

### **PSS26NHP**

• 26.8 cu. ft. capacity

### **PSS29NHP** (not shown)

• **28.7 cu. ft. capacity**

### **PSS26SHP Stainless steel** (not shown)

• 26.8 cu. ft. capacity • Sculptured stainless-look handles and black dispenser

# GE Profile Arctica™ Side-By-Side Models featuring CustomCool™ technology

**These models include** • CustomCool technology with full extension drawer • ClimateKeeper™ system • TurboCool™ setting • Upfront electronic touch temperature controls • Digital temperature display • FrostGuard™ technology • In-the-door beverage rack • Integrated Ice™ system • Premium quiet design • Integrated shelf support system • QuickSpace™ shelf • Two slide-out, spillproof glass shelves • ClearLook™ adjustable door bins • Gallon door storage • **Slide 'n Store™ full-extension freezer basket** • Slide 'n Store freezer baskets • Tilt-out wire freezer door bins • Contoured doors • **Tri-level lighting** • NeverClean™ condenser

**Dispenser models include** • SmartWater™ Plus filtration system • Quick Ice™ feature • Water filter indicator light • LightTouch! tall dispenser with child lock and door alarm Note: bold = feature upgrade from previous model



**ONLY GE HAS IT!**

CustomCool technology chills food and beverages in minutes (not hours), thaws frozen food in hours (not days) and allows you to select just-right temperatures for fruits and vegetables.



**ONLY GE HAS IT!**

ClimateKeeper system combines a multifold air system, electronic sensors and electronic touch controls to keep temperatures consistent and help preserve refrigerator contents.



**ONLY GE HAS IT!**

Slide 'n Store freezer basket provides convenient storage for taller items, like pizza boxes.



Refreshment center provides easy access to frequently used items.



## GE Profile

### Dispenser Models

#### PSW26SGP Stainless steel

- 25.5 cu. ft. capacity • **Stainless-wrapped exterior** • Sculptured stainless-look handles and black dispenser



As an ENERGY STAR® partner, GE has determined that this product meets the ENERGY STAR® guidelines for energy efficiency.

(Model PSW26SGP exceeds ENERGY STAR standards by more than 5%)



## GE Profile

### Dispenser Models

#### PSS26SGP Stainless steel

- 25.5 cu. ft. capacity • Sculptured stainless-look handles and black dispenser

#### PSS27SGP (not shown)

- 26.6 cu. ft. capacity • Sculptured Profile handles and black dispenser

#### PSS26NGP (not shown)

- 25.5 cu. ft. capacity • Contoured Profile handles

#### PSF26NGP High-gloss finish (not shown)

- **25.5 cu. ft. capacity** • Contoured Profile handles

#### PSS27NGP (not shown)

- 26.6 cu. ft. capacity • Contoured Profile handles

#### PSS29NGP (not shown)

- **28.6 cu. ft. capacity** • Contoured Profile handles



As an ENERGY STAR® partner, GE has determined that this product meets the ENERGY STAR® guidelines for energy efficiency.

(Models PSF26NGP, PSS26SGP and PSS26NGP exceed ENERGY STAR standards by more than 15%)

Not all features available on all models.

# GE Profile Arctica Side-By-Side Models

**These models include** • Contoured doors • ClimateKeeper system • TurboCool setting • Upfront electronic touch temperature controls • FrostGuard technology • **In-the-door beverage rack** • **Integrated Ice system** • SmartWater Plus filtration system • **Quick Ice feature** • Water filter indicator light • LightTouch! tall dispenser with child lock and door alarm • Premium quiet design • Integrated shelf support system • QuickSpace shelf • Two slide-out, spillproof glass shelves • ClearLook adjustable door bins • Gallon door storage • Wire slide-out freezer baskets • **Tilt-out wire freezer door bins** • **Contoured Profile handles** • Dual-level lighting • NeverClean condenser

Note: bold = feature upgrade from previous model



Quick Ice feature provides up to 50% more ice than normal settings for parties and social gatherings.

**ONLY GE HAS IT!**



Tall LightTouch! dispenser fills sport bottles, pitchers, even blenders! Delivers chilled filtered water, crushed or cubed ice.



Premium quiet design—GE's best noise reduction system.



TurboCool™ setting helps the refrigerator quickly restore the temperature when groceries or heated foods are placed inside.



## GE Profile Dispenser Models

### PSS26MGP

- 25.5 cu. ft. capacity



As an ENERGY STAR® partner, GE has determined that this product meets the ENERGY STAR® guidelines for energy efficiency.

(Model PSS26MGP exceeds ENERGY STAR standards by more than 5%)

Not all features available on all models.

# GE Profile Arctica CustomStyle™ Side-By-Side Refrigerators

## Installed trim Side-by-side models

**Designed for today's  
discriminating consumers.**

CustomStyle refrigerators with installed trim accept stainless steel or acrylic panels in white, black or bisque, all of which can be ordered from GE. To achieve a custom look, you can order wood panels from your cabinetmaker. You'll discover all kinds of ways to enhance your kitchen.



### **Optional Acrylic Panels**

Choose stainless steel panels or acrylic panels in white, bisque or black.



### **Custom Wood Panels**

Make and install your own custom wood panels to accent cabinetry.

## Dispenser Models



### **PSI23NGP\***

Shown with optional black acrylic panels. Available in white, bisque or black.



### **PSI23NGP\***

Shown with custom wood panels. Available in white, bisque or black.



### **PSI23MGP**

Shown with optional white acrylic panels. Available in white, bisque or black.



### **PSI23MGP**

Shown with custom wood panels. Available in white, bisque or black.

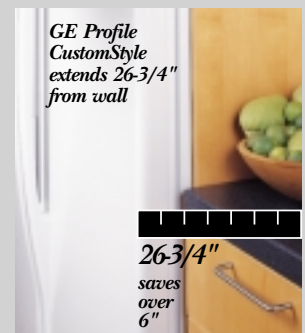

### **PSI23NCP**

Shown with optional white acrylic panels. Available in white, bisque or black.



### **PSI23NCP**

Shown with custom wood panels. Available in white bisque, or black.

### **Optional collar trim: adding the final touch.**

The optional collar trim is just another way GE lets you integrate our CustomStyle refrigerators into your kitchen decor. Available in stainless steel, white, bisque and black, this trim frames the refrigerator facade, adding to the finished look of a built-in, custom kitchen.

Collar trim: TRMBISSS, TRMBISWWW, TRMBISCC, TRMBISBB.

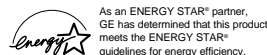

\*ENERGY STAR® models PSH23NGP and PSH23SGP also available.

### **Side-By-Side Refrigerators**

Because they install nearly flush with the cabinets, these refrigerators save floor space. They don't stick out into the kitchen!



Trimless  
Side-by-side models

**Installation made easy, simply slide in.**

The trimless CustomStyle units install by simply sliding into—way into—the space between cabinets. CustomStyle refrigerators, because they align with counters, instantly look built-in, and there's nothing to attach or build. (Available in stainless steel, white, bisque and black.)

Dispenser Models



**PSC23SHP**  
Stainless steel with contoured black handles.



**PSC23NHP**  
Available in white, bisque or black.



**PSC23SGP**  
Stainless steel with sculptured stainless-look handles.



**PSC23NGP**  
Available in white, bisque or black.



**PSI23SGP\***  
Stainless steel with full-length stainless handles.

Dispenser Models



**PSC23MGP**  
Available in white, bisque or black.

Non-Dispenser Model



**PSI23SCP**  
Stainless steel with full-length stainless handles.

# GE Profile Arctica CustomStyle™ Side-By-Side Models featuring CustomCool™ technology

**These models include** • CustomCool technology • ClimateKeeper™ system • TurboCool™ setting • Upfront electronic touch temperature controls • Digital temperature display • FrostGuard™ technology • In-the-door beverage rack • Integrated Ice™ system • Premium quiet design • Integrated shelf support system • QuickSpace™ shelf • Two slide-out, spillproof glass shelves • ClearLook™ adjustable door bins • Gallon door storage • **Slide 'n Store™ full-extension freezer basket** • Slide 'n Store freezer basket • Tilt-out wire freezer door bins • **Tri-level lighting** • NeverClean™ condenser

**Dispenser models include** • SmartWater™ Plus filtration system • Quick Ice™ feature • Water filter indicator light • LightTouch! dispenser with child lock and door alarm **Note: bold = feature upgrade from previous model**

**ONLY GE HAS IT!**

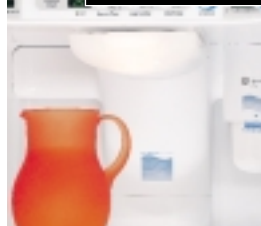

ClimateKeeper system combines a multiframe air system, electronic sensors and electronic touch controls to keep temperatures consistent and help preserve refrigerator contents.

**ONLY GE HAS IT!**



The ExpressThaw™ setting in the exclusive CustomCool bin safely thaws meats and other freezer items in hours, not days!



Refreshment center provides easy access to frequently used items.

**ONLY GE HAS IT!**



Slide 'n Store freezer basket provides convenient storage for taller items, like pizza boxes.



## GE Profile™

### Trimless Refreshment Center Dispenser Models

#### **PSC23SHP** Stainless steel

• 22.7 cu. ft. capacity • Trimless rounded doors, sculptured stainless-look handles and black dispenser

#### **PSC23NHP** (not shown)

• 22.7 cu. ft. capacity • Trimless rounded doors and color-matched contoured Profile handles and dispenser

### Trimless Dispenser Models

#### **PSC23NGP** (not shown)

• 22.6 cu. ft. capacity • Trimless rounded doors and color-matched contoured Profile handles and dispenser

#### **PSC23SGP** Stainless steel (not shown)

• 22.6 cu. ft. capacity • Trimless rounded doors, sculptured stainless-look handles and black dispenser

Not all features available on all models.



**PSI23NGPWW**  
Shown with optional white acrylic panels.



**PSI23NGPBB**  
Shown with custom wood panels.\*

**GE Profile**

*Installed Trim Dispenser Model*

**PSI23NGP**

- 22.6 cu. ft. capacity • Squared doors • Full-length color-matched handles

**PSH23NGP** (not shown)

- 22.6 cu. ft. capacity • Squared doors • Full-length color-matched handles

*Trimless Dispenser Models*

**PSI23SGP Stainless steel** (not shown)

- 22.6 cu. ft. capacity • Squared doors, full-length handles with stainless steel appearance and black dispenser

**PSH23SGP** (not shown)

- 22.6 cu. ft. capacity • Squared doors, full-length handles with stainless steel appearance and black dispenser

*Installed Trim Non-Dispenser Model*

**PSI23NCP** (not shown)

- 22.6 cu. ft. capacity • Squared doors
- Full-length color-matched handles

*Trimless Non-Dispenser Model*

**PSI23SCP Stainless steel** (not shown)

- 22.6 cu. ft. capacity • Squared doors, full-length handles with stainless steel appearance



As an ENERGY STAR® partner, GE has determined that this product meets the ENERGY STAR® guidelines for energy efficiency.

(Models PSH23NGP and PSH23SGP)



TurboCool setting helps the refrigerator quickly restore the temperature when groceries or heated foods are placed inside.



Quick Ice feature provides up to 50% more ice than normal settings for parties and social gatherings.

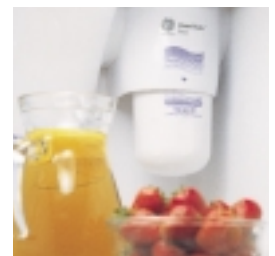

SmartWater Plus filtration system provides clean, better-tasting water and ice through the LightTouch! dispenser. (1 year/500 gallons)



Premium quiet design—GE's best noise-reduction system.

\*Wood panels not supplied by General Electric.

# GE Profile Arctica CustomStyle™ Side-By-Side Models

**These models include** • ClimateKeeper™ system • TurboCool™ setting • Upfront electronic touch temperature controls • FrostGuard™ technology • **In-the-door beverage rack** • **Integrated Ice™ system** • SmartWater™ Plus filtration system • **Quick Ice™ feature** • Water filter indicator light • LightTouch! dispenser with child lock and door alarm • **Premium quiet design** • Integrated shelf support system • QuickSpace™ shelf • Two slide-out, spillproof glass shelves • **ClearLook™ adjustable door bins** • Gallon door storage • Wire slide-out freezer baskets • **Tilt-out wire freezer door bins** • Dual-level lighting • NeverClean™ condenser

Note bold = feature upgrade from previous model



ClimateKeeper system combines a multiflow air system, electronic sensors and electronic touch controls to keep temperatures consistent and help preserve refrigerator contents.



TurboCool setting helps the refrigerator quickly restore the temperature when groceries or heated foods are placed inside.



Upfront electronic touch temperature controls are easy to see and set.



FrostGuard technology reduces freezer burn by monitoring door openings and usage, defrosting only as needed.

Not all features available on all models.



## *GE Profile Trimless Dispenser Model*

### **PSC23MGP**

• 22.7 cu. ft. capacity • Trimless rounded doors and color-matched contoured Profile handles and dispenser



**PSI23MGPWW**  
Shown with optional white acrylic panels.

*GE Profile  
Installed Trim Dispenser Model*

- PSI23MGP**  
 • 22.7 cu. ft. capacity • Squared doors, full-length color-matched handles



**PSI23MGPC**  
Shown with custom wood panels.\*

\*Wood panels not supplied by General Electric.

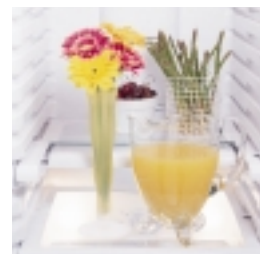

Integrated shelf support system offers maximum storage flexibility with easy-to-remove shelves.



Quick Ice feature provides up to 50% more ice than normal settings for parties and social gatherings.



QuickSpace shelf slides back easily for tall items, maximizing storage space.



Tall LightTouch! dispenser fills sport bottles, pitchers, even blenders! Delivers chilled filtered water, crushed or cubed ice.

## GE® Side-By-Side “L” Series Models: 25 cu. ft.

**These models include** • Upfront electronic touch temperature controls • FrostGuard™ technology • **TurboCool™ setting** • SmartWater™ Plus filtration system • **LightTouch! tall dispenser with child lock and door alarm** • **Integrated Ice™ system** • Water filter indicator light • **Integrated shelf support system** • **QuickSpace™ shelf** • Two adjustable slide-out, spillproof glass shelves • Snack pan • Adjustable humidity vegetable/fruit crisper • **Three wire slide-out freezer baskets** • Deluxe quiet design • Dual-level lighting • NeverClean™ condenser

**Note: bold = feature upgrade from previous model**



TurboCool setting helps the refrigerator quickly restore the temperature when groceries or heated foods are placed inside.



Upfront electronic touch temperature controls are easy to see and set.



GE  
Dispenser Models

**GSS25LGP**

• 24.5 cu. ft. capacity

**GSS25LSP Stainless steel**  
(not shown)

• 24.5 cu. ft. capacity • Black handles and black dispenser



As an ENERGY STAR® partner, GE has determined that this product meets the ENERGY STAR® guidelines for energy efficiency.

(Models GSS25LGP, GSS25LSP, GSS25XGP and GSS25XSP)

## GE Side-By-Side “S” Series Models: 25 to 22 cu. ft.

**These models include** • Upfront electronic touch temperature controls • FrostGuard technology • SmartWater Plus filtration system • **LightTouch! tall dispenser with child lock** • Water filter indicator light • Two adjustable slide-out, spillproof glass shelves • Snack pan • Adjustable humidity vegetable/fruit crisper • Adjustable temperature deli pan • Adjustable gallon door storage • Four wire freezer shelves, three adjustable • One wire slide-out freezer basket • Deluxe quiet design • Dual-level lighting • NeverClean condenser • Stainless steel handles and black dispenser trim

**Note: bold = feature upgrade from previous model**



Convenient upfront electronic temperature controls are easy to see and set.



Fresh food gallon door storage provides maximum storage flexibility.



GE  
Dispenser Models

**GSS25SGP Stainless steel**

• 24.9 cu. ft. capacity

**GSH25SGP Stainless steel**  
(not shown)

• 24.9 cu. ft. capacity

**GSS22SGP Stainless steel**  
(not shown)

• 21.8 cu. ft. capacity

**GSH22SGP Stainless steel**  
(not shown)

• 21.8 cu. ft. capacity



As an ENERGY STAR® partner, GE has determined that this product meets the ENERGY STAR® guidelines for energy efficiency.

(Models GSH25SGP and GSH22SGP)

## GE Side-By-Side “K” Series Models: 25 to 22 cu. ft.

**These models include** • Upfront electronic touch temperature controls • FrostGuard technology • **SmartWater Plus filtration system** • **LightTouch!** tall dispenser with child lock • **Water filter indicator light** • **Two adjustable slide-out, spillproof glass shelves** • **Snack pan** • **Adjustable humidity vegetable/fruit crisper** • Adjustable temperature deli pan • Adjustable gallon door storage • Four wire freezer shelves, three adjustable • **One wire slide-out freezer basket** • Deluxe quiet design • **Dual-level lighting** • NeverClean condenser

Note: bold = feature upgrade from previous model



SmartWater Plus filtration system provides clean, better-tasting water and ice through the LightTouch! dispenser. (1 year/500 gallons)



FrostGuard technology reduces freezer burn by monitoring door openings and usage, defrosting only as needed.



GE Dispenser Models  
**GSH25KGP** (not shown)  
 • 24.9 cu. ft. capacity  
**GSS25KGP**  
 • 24.9 cu. ft. capacity  
**GSS22KGP** (not shown)  
 • 21.8 cu. ft. capacity  
**GSH22KGP** (not shown)  
 • 21.8 cu. ft. capacity

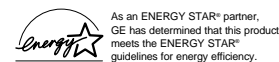

(Models GSH25KGP and GSH22KGP)

## GE Side-By-Side “J” Series Models: 25 to 22 cu. ft.

**These models include** • Upfront electronic temperature controls • FrostGuard technology • LightTouch! tall dispenser • **Three adjustable spillproof glass shelves** • Sealed crisper • Adjustable temperature deli pan • **Adjustable gallon door storage** • Deluxe quiet design • NeverClean condenser

Note: bold = feature upgrade from previous model

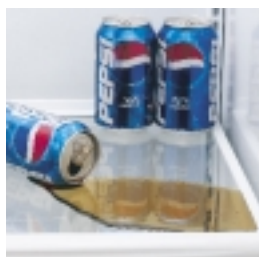

Spillproof shelves help contain spills for ease of cleaning.



SmartWater filtration system provides clean, better-tasting water and ice through the LightTouch! dispenser. (6 months/300 gallons)



GE Dispenser Models  
**GSS25JFP**  
 • 24.9 cu. ft. capacity  
 • SmartWater filtration system  
**GSH25JFP** (not shown)  
 • 24.9 cu. ft. capacity  
**GSL25JFP CleanSteel™**  
 (not shown)  
 • 24.9 cu. ft. capacity  
**GSS22JFP** (not shown)  
 • 21.8 cu. ft. capacity  
 • **SmartWater filtration system**  
**GSH22JFP** (not shown)  
 • 21.8 cu. ft. capacity  
**GSL22JFP CleanSteel**  
 (not shown)  
 • 21.8 cu. ft. capacity

Non-Filtration Models  
**GSS25JEP** (not shown)  
 • 24.9 cu. ft. capacity  
**GSS22JEP** (not shown)  
 • 21.8 cu. ft. capacity

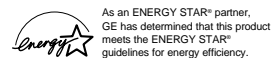

(Models GSH25JFP and GSH22JFP)

## GE® Side-By-Side “I” Series Models: 22 to 20 cu. ft.

**These models include** • Upfront electronic temperature controls • FrostGuard™ technology • **Three adjustable glass shelves** • Sealed crisper • Gallon storage door bins • Deluxe quiet design • NeverClean™ condenser

**Note: bold = feature upgrade from previous model**



Fresh food gallon door storage provides maximum storage flexibility.



Deluxe quiet design—quiet components and insulation allow for quiet operation.



GE  
Dispenser Model

**GSS20IEP**

• 19.9 cu. ft. capacity • **LightTouch!** tall dispenser • **Adjustable temperature deli pan**



GE  
Non-Dispenser Models

**GSS22IBP** (not shown)

• 21.7 cu. ft. capacity • **Two adjustable fresh food door bins** • Sealed deli pan • Equipped for optional electronic icemaker

**GSS20IBP**

• 19.8 cu. ft. capacity • Sealed deli pan • Equipped for optional electronic icemaker

Not all features available on all models.

## GE Side-By-Side “D” Series Model: 20 cu. ft.

***This model includes*** • Upfront electronic temperature controls • FrostGuard technology • Three wire fresh food shelves • Equipped for optional electronic icemaker • Sealed crisper • Sealed deli pan • Four fresh food door bins, two with gallon storage • Four wire freezer shelves, three adjustable • Deluxe quiet design • NeverClean condenser

**Note: bold = feature upgrade from previous model**



Deluxe quiet design—quiet components and insulation allow for quiet operation.



Gallon door storage accommodates gallon containers for quick access to most-used items.



GE  
Non-Dispenser Model  
**GSS20DBP**  
• 19.8 cu. ft. capacity

# GE Profile Arctica™ Top-Freezer Refrigerators

## Top Performance.

Elegant curvaceous design graces Arctica top-freezer refrigerators, which are distinguished by radius doors and rounded storage bins.

Arctica's performance is even more dramatic.

The innovative ClimateKeeper™ system adapts to levels of activity and location, keeping the temperature on an even keel.

Arctica top-freezers not only provide precise temperature management, but they also offer optimal ease and accessibility.

Adjustable storage bins put all contents within convenient reach, while the dual fresh food lighting system and freezer dome light let you fully satisfy your midnight cravings.



**ONLY GE HAS IT!**

### Rapid recovery

Exclusive ClimateKeeper system quickly recovers from such variables as frequent door openings and changes in external temperature.



**ONLY GE HAS IT!**

### Freezer innovation

Exclusive FrostGuard™ technology reduces freezer burn.



*Stunningly styled inside and out, the GE Profile Arctica top-freezer refrigerators give you a brand-new way to enhance your kitchen.*

# GE Profile Arctica Top-Freezer Models: 25 to 22 cu. ft.

**These models include** • Upfront electronic digital temperature display • GE SmartWater filtration • Factory-installed electronic icemaker • ClimateKeeper system • FrostGuard technology • Premium quiet design • ShelfSaver™ rack • Lift-off, slide-out, spillproof glass shelves, four adjustable/split • Two adjustable humidity vegetable/fruit crispers • Adjustable temperature deli pan • Pivot-out pan removal system • One full-width, fixed tall bottle door bin • ClearLook™ adjustable gallon door bins • Spillproof freezer floor • Tilt-out locking freezer door bin • Dual-level lighting • NeverClean™ condenser **Note: bold = feature upgrade from previous model**



Internal water dispenser lets you enjoy the fresh taste of clean, filtered water from inside the refrigerator.



Convenient, upfront electronic touch temperature controls are extremely accurate, easy to see and easy to set.

**ONLY GE HAS IT!**



Pivot-out pan removal system makes cleaning crispers easier than ever.



ShelfSaver™ beverage rack provides convenient storage for a 12-pack, two egg cartons or a 9" x 13" casserole dish.



## GE Profile™ Water Dispenser Models

- PTS25SHP Stainless steel** (not shown)
  - 24.6 cu. ft. capacity
- PTS22SHP Stainless steel** (not shown)
  - 21.7 cu. ft. capacity
- PTS25LHP**
  - 24.6 cu. ft. capacity
- PTS22LHP** (not shown)
  - 21.7 cu. ft. capacity

## Non-Dispenser Models

- PTS22SCP Stainless steel** (not shown)
  - 21.7 cu. ft. capacity
- PTS22LCP** (not shown)
  - 21.7 cu. ft. capacity



As an ENERGY STAR® partner, GE has determined that this product meets the ENERGY STAR® guidelines for energy efficiency.

(Models PTS25SHP, PTS22SHP, PTS22SCP, PTS25LHP, PTS22LHP and PTS22LCP.)

# GE Profile CustomStyle™ Top-Freezer Refrigerators

## Installed trim Top-freezer models

**Designed for today's  
discriminating consumers.**

CustomStyle refrigerators with installed trim accept stainless steel or acrylic panels in white or black, all of which can be ordered from GE. To achieve a custom look, you can order wood panels from your cabinetmaker.

You'll discover all kinds of ways to enhance your kitchen.



### **Optional Acrylic Panels**

Choose stainless steel panels or acrylic panels in white or black.

### **Custom Wood Panels**

Make and install your own custom wood panels to accent cabinetry.

## Dispenser Models



**PTI22SFM**  
Shown with installed stainless steel panels.



**PTI22MFM**  
Shown with optional white acrylic panels. Available in white or black.



**PTI22MFM**  
Shown with optional stainless steel panels. Available in white or black.



**PTI22MFM**  
Shown with custom wood panels. Available in white or black.

## Non-Dispenser Models



**PTI22MBM**  
Shown with optional black acrylic panels. Available in white or black.



**PTI22MBM**  
Shown with optional stainless steel panels. Available in white or black.



**PTI22MBM**  
Shown with custom wood panels. Available in white or black.

### **Optional collar trim: adding the final touch.**

The optional collar trim is just another way GE lets you integrate our CustomStyle refrigerators into your kitchen decor. Available in stainless steel, white and black, this trim frames the refrigerator facade, adding to the finished look of a built-in, custom kitchen. Collar trim: TRMBISSS, TRMBISVWW, TRMBISBB.



### **Top-Freezer Refrigerators**

Because they install nearly flush with the cabinets, these refrigerators save floor space. They don't stick out into the kitchen!



Trimless  
Top-freezer models

**Installation made easy, simply slide in.**

The trimless CustomStyle units install by simply sliding into—way into—the space between cabinets. CustomStyle refrigerators, because they align with counters, instantly look built-in, and there’s nothing to attach or build. (Available in stainless steel, white, bisque and black.)

Dispenser Models



**PTC22SFM**  
Stainless steel.



**PTC22MFM**  
Available in white, bisque or black.

Non-Dispenser Models



**PTC22SBM**  
Stainless steel.



**PTC22MBM**  
Available in white or black.

# GE Profile CustomStyle™ Top-Freezer Models: 22 cu. ft.

**These models include** • Upfront illuminated temperature controls • Beverage rack • **QuickSpace™ shelf** • Adjustable slide-out, spillproof glass shelves • Two adjustable humidity vegetable/fruit crispers • **Slide-out, spillproof crisper cover** • **ClearLook™ gallon door bins** • **Adjustable temperature meat pan** • Dairy compartment • **Upfront fresh food lighting** • Deluxe quiet design • NeverClean™ condenser

**Dispenser models include** • **LightTouch! dispenser delivers cubes, crushed ice and chilled water** • SmartWater™ filtration system

Note: bold = feature upgrade from previous model



SmartWater filtration system provides clean, better-tasting water and ice through the LightTouch! dispenser. (6 months/300 gallons)



QuickSpace shelf slides back to store tall items.

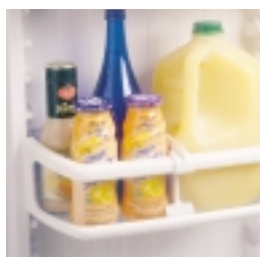

ClearLook adjustable door bins store gallon containers with ease.



## GE Profile™ Trimless Dispenser Models

### PTC22SFM Stainless steel

• 21.7 cu. ft. capacity • Trimless rounded doors, black contoured Profile handles and black dispenser

### PTC22MFM (not shown)

• 21.7 cu. ft. capacity • Trimless rounded doors and contoured Profile handles



As an ENERGY STAR® partner, GE has determined that this product meets the ENERGY STAR® guidelines for energy efficiency.

(Models PTC22SFM and PTC22MFM)

## Trimless Non-Dispenser Models

### PTC22SBM Stainless steel (not shown)

• 21.9 cu. ft. capacity • Trimless rounded doors, black contoured Profile handles • Equipped for optional electronic icemaker

### PTC22MBM (not shown)

• 21.9 cu. ft. capacity • Trimless rounded doors and contoured Profile handles • Equipped for optional electronic icemaker



**GE Profile**

*Installed Trim Dispenser Models*

**PTI22SFM Stainless steel**

- 21.7 cu. ft. capacity • Factory-installed stainless steel panels, trim, full-length handles and black dispenser

**PTI22MFM (not shown)**

- 21.7 cu. ft. capacity

*Installed Trim Non-Dispenser Model*

**PTI22MBM (not shown)**

- 21.9 cu. ft. capacity • Equipped for optional electronic icemaker

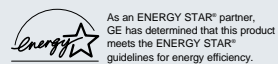

(Models PTI22SFM and PTI22MFM)



LightTouch! dispenser delivers cubes, crushed ice and chilled water.



Deluxe quiet design—quiet components and insulation allow for quiet operation.



Upfront illuminated temperature controls are easy to see and set.

# GE® Top-Freezer “K” Series Models: 22 to 16 cu. ft.

- These models include** • Upfront illuminated temperature controls • Dual-level lighting • **Four adjustable spillproof glass shelves** • **Three adjustable gallon door bins** • **One fixed tall bottle door bin** • Snack pan • **Two adjustable humidity vegetable/fruit crispers** • Spillproof freezer floor • Deluxe quiet design • **Freezer light** • NeverClean™ condenser Note: bold = feature upgrade from previous model



Internal water dispenser lets you enjoy the fresh taste of clean, filtered water from inside the refrigerator.

**ONLY GE HAS IT!**



Pivot-out pan removal system makes cleaning crispers easier than ever (22 cu. ft. model only).



Seamless, spillproof freezer floor design makes freezer cleanup simple!



Adjustable gallon door bins store gallon containers with ease.



## GE Dispenser Models

### **GTS22KHP**

- 21.7 cu. ft. capacity • Internal water dispenser • GE SmartWater™ filtration • Pivot-out pan removal system • Factory-installed icemaker

### **GTH22SHP Stainless steel** (not shown)

- 21.7 cu. ft. capacity • FrostGuard technology • Internal water dispenser • GE SmartWater filtration • Pivot-out pan removal system • Electronic temperature sensors • Factory-installed icemaker

### **GTS18KHP** (not shown)

- 17.9 cu. ft. capacity • Internal water dispenser • GE SmartWater filtration • Factory-installed icemaker

### **GTS18SHP Stainless steel** (not shown)

- 17.9 cu. ft. capacity • Internal water dispenser • GE SmartWater filtration • Factory-installed icemaker

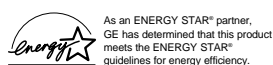

(Model GTH22SHP)

Not all features available on all models.



Upfront illuminated temperature controls are easy to see and set.



Spillproof shelves help contain spills for ease of cleaning.



Exclusive FrostGuard™ technology reduces freezer burn.

**GE**

**Non-Icemaker Models**

**GTS22KBP**

- 21.7 cu. ft. capacity • Pivot-out pan removal system
- Equipped for optional icemaker

**GTH22SBN Stainless steel** (not shown)

- 21.7 cu. ft. capacity • FrostGuard technology
- Pivot-out pan removal system • Electronic temperature sensors • Equipped for optional icemaker

**GTS18SBP Stainless steel** (not shown)

- 17.9 cu. ft. capacity • Equipped for optional icemaker

**GTS18KBP** (not shown)

- 17.9 cu. ft. capacity • Equipped for optional icemaker

**GTH18KBP** (not shown)

- 17.9 cu. ft. capacity • Equipped for optional icemaker

**GTL18KBP CleanSteel™** (not shown)

- 17.9 cu. ft. capacity • Equipped for optional icemaker

**GTS16KBM** (not shown)

- 15.6 cu. ft. capacity

**Icemaker Models**

**GTS22KCP** (not shown)

- 21.7 cu. ft. capacity • Pivot-out pan removal system

**GTS18KCP** (not shown)

- 17.9 cu. ft. capacity

**GTL18KCP CleanSteel** (not shown)

- 17.9 cu. ft. capacity



As an ENERGY STAR® partner, GE has determined that this product meets the ENERGY STAR® guidelines for energy efficiency.

(Models GTH22SBN and GTH18KBP)

# GE® Top-Freezer “J” Series Models: 22 to 18 cu. ft.

**These models include** • Upfront illuminated temperature controls • Dual-level lighting • Three spillproof glass shelves, two adjustable split and one full-width • Two vegetable/fruit crispers • Snack pan • Two full-width encapsulated door bins, one with gallon storage • Spillproof freezer floor • Deluxe quiet design • NeverClean™ condenser

Note: bold = feature upgrade from previous model



Gallon door storage accommodates gallon containers for quick access to most-used items.



Seamless, spillproof freezer floor design makes freezer cleanup simple!



Spillproof shelves help contain spills for ease of cleaning.



## GE® Icemaker Models

### **GTS22JCP**

- 21.8 cu. ft. capacity • Pivot-out pan removal system
- Electronic temperature sensors

### **GTS18JCP** (not shown)

- 17.9 cu. ft. capacity



## GE Non-Icemaker Models

### **GTS22JBP** (not shown)

- 21.8 cu. ft. capacity • Pivot-out pan removal system
- Electronic temperature sensors • Equipped for optional electronic icemaker

### **GTS18JBP**

- 17.9 cu. ft. capacity • Equipped for optional icemaker

### **GTH18JBP** (not shown)

- 17.9 cu. ft. capacity • Equipped for optional icemaker



As an ENERGY STAR® partner, GE has determined that this product meets the ENERGY STAR® guidelines for energy efficiency.

(Model GTH18JBP)

## GE Top-Freezer “I” Series Models: 20 cu. ft.

**These models include** • Upfront temperature controls • **Three full-width gallon door bins, two adjustable** • **Three glass shelves, two adjustable split and one full-width** • Two vegetable/fruit crispers • Snack pan • **Spillproof freezer floor** • Deluxe quiet design • NeverClean™ condenser **Note: bold = feature upgrade from previous model**



Gallon door storage accommodates gallon containers for quick access to most-used items.



Adjustable humidity crispers provide the ideal storage environment for fruits and vegetables.



### GE Icemaker Models

#### **GTS20ICN**

- 20.0 cu. ft. capacity • Three SpillKeeper™ glass shelves, two adjustable split and one full-width
- Three full-width gallon door bins (two adjustable)

### Non-Icemaker Models

#### **GTS20IBN** (not shown)

- 20.0 cu. ft. capacity • Equipped for optional icemaker

## GE Top-Freezer “H” Series Models: 18 cu. ft.

**This model includes** • Upfront temperature control • **Three adjustable glass shelves, two split and one full-width** • Two vegetable/fruit crispers • Snack pan • Two door shelves with gallon storage • Deluxe quiet design • NeverClean condenser

**Note: bold = feature upgrade from previous model**



Gallon door storage accommodates gallon containers for quick access to most-used items.



Clear crispers provide easy storage for vegetables and fruits.



### GE Non-Icemaker Model

#### **GTS18HBM**

- 17.6 cu. ft. capacity • Equipped for optional icemaker

### Icemaker Model

#### **GTS18HCM** (not shown)

- 17.6 cu. ft. capacity

## GE® Top-Freezer “F” Series Models: 22 to 18 cu. ft.

**These models include** • Three cabinet shelves, two wire and one glass • **Two clear vegetable/fruit crispers** • Snack pan  
 • **Gallon door storage** • Deluxe quiet design • Equipped for optional icemaker • NeverClean™ condenser

Note: bold = feature upgrade from previous model



Upfront temperature controls are easy to see and set.



Snack pan conveniently stores rewrapped meats, cheeses and snacks.



### GE Non-Icemaker Models **GTS22FBP**

• 21.8 cu. ft. capacity • Upfront temperature controls • **Three door shelves, two with gallon storage** • **Spillproof freezer floor** • **Pivot-out pan removal system**

### **GTS18FBM** (not shown)

• 17.6 cu. ft. capacity • Two door shelves with gallon storage

## GE Top-Freezer “E” Series Model: 18 cu. ft.

**This model includes** • Three cabinet shelves, one full-width wire, one split wire and one split glass • Two vegetable/fruit crispers  
 • **Snack pan** • Two door shelves with tall bottle storage • **Utility bin** • Deluxe quiet design • Equipped for optional icemaker  
 • NeverClean condenser

Note: bold = feature upgrade from previous model



Deluxe quiet design—quiet components and insulation allow for quiet operation.



NeverClean condenser coils are rolled up and encased, so they never require cleaning in normal operating environments.



### GE Non-Icemaker Model **GTS18EBM**

• 17.6 cu. ft. capacity

## GE Top-Freezer “B” Series Models: 18 to 12 cu. ft.

**These models include** • Upfront temperature controls • **Two vegetable/fruit crispers** • Two fixed door shelves with tall bottle storage • **Two adjustable wire full-width shelves** • Two fixed freezer door shelves • Deluxe quiet design • **NeverClean condenser**

Note: bold = feature upgrade from previous model

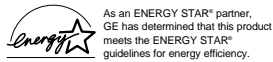

(Model GTH15BBM)

### GE Non-Icemaker Models

#### **GTR18BBM**

- **17.6 cu. ft. capacity** • Recessed handles
- Equipped for optional icemaker

#### **GTS17BBM** (not shown)

- 16.9 cu. ft. capacity • Equipped for optional icemaker

#### **GTR17BBM** (not shown)

- **16.9 cu. ft. capacity** • Recessed handles
- Equipped for optional icemaker

#### **GTS15BBM** (not shown)

- 14.6 cu. ft. capacity • Equipped for optional icemaker

#### **GTH15BBM** (not shown)

- 14.6 cu. ft. capacity • Equipped for optional icemaker

#### **GTR15BBM** (not shown)

- 14.6 cu. ft. capacity • Recessed handles
- Equipped for optional icemaker

#### **GTS12BBP** (not shown)

- 11.7 cu. ft. capacity

### Icemaker Models

#### **GTS17BCM** (not shown)

- **16.9 cu. ft. capacity**

#### **GTS15BCM** (not shown)

- 14.6 cu. ft. capacity

## GE Top-Freezer “A” Series Models: 18 to 11 cu. ft.

**These models include** • Upfront temperature controls • Two wire full-width shelves • One full-width vegetable/fruit crisper • Deluxe quiet design

Note: bold = feature upgrade from previous model



### GE Non-Icemaker Models

#### **GTS18ABM**

- **17.6 cu. ft. capacity** • **Two fixed door shelves with tall bottle storage** • **Equipped for optional icemaker** • **NeverClean condenser**

#### **GTR11AAP** (not shown)

- 11.4 cu. ft. capacity • One wire full-width freezer shelf

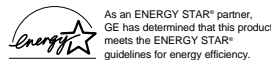

(Model GTR11AAP)

# GE® Top-Freezer Cycle and Manual Defrost Refrigerators

**These models include** • Two adjustable wire cabinet shelves • Tall bottle storage

Note: bold = feature upgrade from previous model



Wire shelves minimize shuffling and restacking of food.



Full-width crisper provides easy access to fruits and vegetables.



GE®  
Cycle Defrost Model

**GFR12AAM**

- 11.7 cu. ft. capacity
- Three door shelves
- Two clear vegetable/fruit crispers



GE  
Manual Defrost Model

**GMS10AAM**

- 9.7 cu. ft. capacity
- Five door shelves (two egg)
- Full-width vegetable/fruit crisper

## GE Spacemaker™ Compact Refrigerators: 6.0 to 1.7 cu. ft.

Note: bold = feature upgrade from previous model



GE  
Compact Model  
**GMR06AAM**

- **6.0 cu. ft. capacity** • Two adjustable cabinet shelves • Three full-width door shelves • Interior light • Optional black panel and door handle available with TK6 trim kit



GE  
Compact Model

- GMR04BAN** (not shown)
- **4.3 cu. ft. capacity** • Two- and one-half wire cabinet shelves • **One full-width, two half-width door shelves** • **Can rack**

- GMR02BAN**
- **1.7 cu. ft. capacity** • One slide-out wire cabinet shelf • One full-width, one half-width door shelves

## Wine Coolers: 3.0 to 4.0 cu. ft.



*GE Profile™*  
Wine Cooler  
**PWR04FAN**

- 4.3 cu. ft. capacity
- Five slide-out shelves (holds 29 bottles)
- Clear glass door
- Electronic adjustable controls • Interior light
- Lock



GE  
Wine Cooler  
**GWR03AAM**

- 2.4 cu. ft. capacity • Four removable shelves (holds 24 bottles) • Clear glass door
- Exterior temperature control knob

# GE Profile Arctica™ Bottom-Freezer Refrigerators

## Fresh Food First.

Arctica bottom-freezers are uniquely configured to put fresh foods within convenient reach. Full-width shelves allow easy access to refrigerator contents, and brilliant lighting allows easy viewing of items.

While these new refrigerators put fresh food first, frozen food storage is also given thoughtful consideration. A multi-level storage system gives you tremendous storage flexibility. Also, an Integrated Icemaker™ gives you all the ice—and space—you need.

Both the fresh food and freezer compartments use innovative cooling technology to help preserve foods and conserve energy. In addition to fresh technology, GE bottom-freezers offer a fresh style twist with contoured doors and sculptured handles.



*GE bottom-freezer refrigerators are a top choice among consumers who want modern design and maximum convenience.*



**ONLY GE HAS IT!**

### Contoured doors and sculptured handles

Gently contoured doors and GE handles offer a dramatic, kitchen-enhancing look.



**ONLY GE HAS IT!**

### ClimateKeeper™ system

Combines upfront electronic touch controls, multiple electronic sensors and a multifold air system to keep temperatures consistent and help keep foods fresh.



**ONLY GE HAS IT!**

### Integrated Icemaker™

Combines an icemaker and ice bin in one system to save space and hassle. The ice bin is built into the icemaker, not the freezer baskets, so cubes don't fall onto the freezer floor.

# GE Profile Arctica Bottom-Freezer Drawer Models: 22 to 20 cu. ft.

**These models include** • Upfront electronic touch controls with digital temperature readout • Adjustable gallon door bins • ShelfSaver™ beverage rack • Slide-out, spillproof glass shelves • **QuickSpace™ shelf** • FrostGuard™ technology • ClearLook™ adjustable gallon door bins • **Multi-level Slide 'n Store™ basket system** • Adjustable humidity vegetable/fruit crispers • **Adjustable temperature deli pan** • Contoured doors • Sculptured handles • NeverClean™ condenser • Deluxe quiet design • Equipped for optional automatic icemaker

**Note: bold = feature upgrade from previous model**



QuickSpace shelf quickly slides out of the way to make room for tall items.



ShelfSaver beverage rack provides space for odd shapes and sizes.

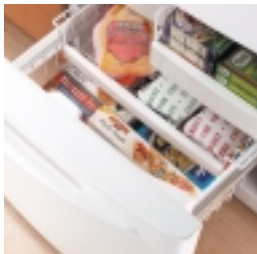

Slide 'n Store freezer drawer provides easy access to frozen foods.



## GE Profile

### Bottom-Freezer Drawer Icemaker Models

#### **PDS20SCP Stainless steel**

- 19.6 cu. ft. capacity • GE SmartWater™ filtration

#### **PDS20MCP** (not shown)

- 19.6 cu. ft. capacity • GE SmartWater filtration

#### **PDS22SCP Stainless steel** (not shown)

- 22.2 cu. ft. capacity • GE SmartWater filtration

#### **PDS22MCP** (not shown)

- 22.2 cu. ft. capacity • GE SmartWater filtration

### Bottom-Freezer Drawer Non-Icemaker Models

#### **PDS20SBP Stainless steel** (not shown)

- 19.6 cu. ft. capacity

#### **PDS20MBP** (not shown)

- 19.6 cu. ft. capacity

#### **PDS22SBP Stainless steel** (not shown)

- 22.2 cu. ft. capacity

#### **PDS22MBP** (not shown)

- 22.2 cu. ft. capacity



As an ENERGY STAR® partner, GE has determined that this product meets the ENERGY STAR® guidelines for energy efficiency.

(Models PDS20SBP, PDS20MBP, PDS22SBP, PDS22MBP, PDS20SCP, PDS20MCP, PDS22SCP and PDS22MCP)

# GE® Bottom-Freezer Drawer Models: 18 cu. ft.

**These models include** • Four adjustable split, spillproof glass shelves (two slide-out) • One full-width, two split Slide 'n Store freezer baskets • Adjustable humidity vegetable/fruit crispers • Snack pan • NeverClean condenser • Deluxe quiet design • Equipped for optional automatic icemaker **Note: bold = feature upgrade from previous model**



Adjustable fresh food gallon door storage provides maximum storage flexibility.



Spillproof shelves help contain spills for ease of cleaning.



Brita filtered water door module holds nearly two gallons of water (18 cu. ft. models only).



## GE® Bottom-Freezer Drawer Models

### **GDS18SBP Stainless steel**

- 18.1 cu. ft. capacity • Brita® filtered water door module • ShelfSaver™ beverage rack
- Stainless steel tubular door handles (must choose left or right hand door opening)

### **GDS18LBP** (not shown)

- 18.1 cu. ft. capacity • Brita® filtered water door module • ShelfSaver beverage rack
- Full-grip, side-mounted color-matched handle



As an ENERGY STAR® partner, GE has determined that this product meets the ENERGY STAR® guidelines for energy efficiency.

## GE® Bottom-Freezer “K” Series Door Models: 22 to 18 cu. ft.

**These models include** • Adjustable spilt glass shelves • Adjustable humidity vegetable/fruit crispers • Snack pan • Adjustable gallon door bins • Full-width sliding freezer basket • NeverClean™ condenser • Deluxe quiet design • Equipped for optional automatic icemaker

Note: bold = feature upgrade from previous model



Adjustable fresh food gallon door storage provides maximum storage flexibility.



Spillproof shelves help contain spills for ease of cleaning.



### GE Bottom-Freezer Door Model

#### **GBS22KBP**

• 22.2 cu. ft. capacity • Spillproof glass shelves

#### **GBS20KBP** (not shown)

• 19.6 cu. ft. capacity

#### **GBS18KBP** (not shown)

• 18.1 cu. ft. capacity



As an ENERGY STAR® partner, GE has determined that this product meets the ENERGY STAR® guidelines for energy efficiency.

## GE® Bottom-Freezer “H” Series Door Models: 22 to 18 cu. ft.

**These models include** • Adjustable spilt glass shelves • Adjustable humidity vegetable/fruit crispers • Snack pan • Adjustable gallon door bins • Full-width sliding freezer basket • NeverClean™ condenser • Deluxe quiet design • Equipped for optional automatic icemaker

Note: bold = feature upgrade from previous model



### GE Bottom-Freezer Door Models

#### **GBS22HBP**

• 22.2 cu. ft. capacity

#### **GBS18HBP**

• 18.1 cu. ft. capacity



As an ENERGY STAR® partner, GE has determined that this product meets the ENERGY STAR® guidelines for energy efficiency.

Not all features available on all models.

# GE® Chest Freezers

## These models include

- Adjustable temperature control
- Upfront defrost water drain

Note: bold = feature upgrade from previous model



Lift-out and sliding wire baskets simplify loading and unloading.



Interior light brightens for easy access.



## GE® Chest Freezer Models

**FCM25RM** (not shown)  
 • 25.1 cu. ft. capacity • **Four lift-out and sliding bulk storage baskets** • Interior light • Built-in lock  
 • Limited food loss warranty\*

**FCM20DM**  
 • 19.7 cu. ft. capacity • **Three lift-out and sliding bulk storage baskets** • Interior light • Built-in lock  
 • Limited food loss warranty\*

**FCM15DM** (not shown)  
 • 14.8 cu. ft. capacity • **Two lift-out and sliding bulk storage baskets** • Interior light • Built-in lock  
 • Limited food loss warranty\*



## GE Chest Freezer Model

**FCM15SM**  
 • 14.8 cu. ft. capacity • One lift-out and sliding bulk storage basket • Limited food loss warranty\*



## GE Chest Freezer Models

**FCM9DM**  
 • 8.8 cu. ft. capacity • Two lift-out and sliding bulk storage baskets • **Interior light**  
 • Built-in lock • Limited food loss warranty\*

**FCM7DN** (not shown)  
 • 7.0 cu. ft. capacity • **Two lift-out and sliding bulk storage baskets** • **Power “ON” light** • Built-in lock • **Limited food loss warranty\***



## GE Chest Freezer Models

**FCM5DM**  
 • 5.0 cu. ft. capacity • Two lift-out and sliding bulk storage baskets • **Power “ON” light** • **Built-in lock**

**FCM5SM** (not shown)  
 • 5.0 cu. ft. capacity • One lift-out and sliding bulk storage basket

\*See written warranty for complete details.

Not all features available on all models.

# GE Upright Freezers

**These models include** • Adjustable temperature control • Limited food loss warranty\*

Note: bold = feature upgrade from previous model

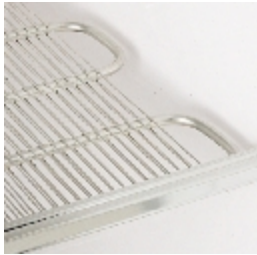

Refrigerated cabinet shelves keep items extra cool.



Slide-out bulk storage basket for maximum freezer capacity.

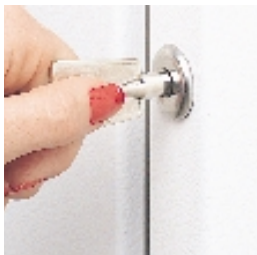

Safety lock provides security.



## GE Deluxe Upright Frost-Free Models **FUF20DM**

- **20.3 cu. ft. capacity** • One slide-out bulk storage basket • **Five cabinet shelves, three adjustable**
- **Six door shelves** • Built-in lock • Interior light

## **FUF17DM** (not shown)

- **16.7 cu. ft. capacity** • One slide-out bulk storage basket • **Four cabinet shelves, three adjustable**
- Five door shelves • Built-in lock • Interior light

## **FUF14DM** (not shown)

- **13.7 cu. ft. capacity** • One slide-out bulk storage basket • **Three cabinet shelves, two adjustable**
- Five door shelves • Built-in lock • Interior light



## GE Deluxe Upright Manual Defrost Models

### **FUM21DM** (not shown)

- **20.6 cu. ft. capacity** • One slide-out bulk storage basket
- **Five cabinet shelves, one adjustable** • **Six door shelves**
- Built-in lock • Interior light • Defrost water drain

### **FUM17DM**

- **17.1 cu. ft. capacity** • One slide-out bulk storage basket
- Four cabinet shelves, one adjustable • Five door shelves
- Built-in lock • Interior light • Defrost water drain

### **FUM14DM** (not shown)

- **14.1 cu. ft. capacity** • One slide-out bulk storage basket
- **Four cabinet shelves, one adjustable** • Five door shelves
- Built-in lock • Interior light • Defrost water drain



## GE Standard Upright Manual Defrost Models

### **FUM14SM**

- **14.1 cu. ft. capacity** • **Three cabinet shelves**
- **Five door shelves** • **Defrost water drain**

### **FUM5SM** (not shown)

- **5.0 cu. ft. capacity** • **Two cabinet shelves**
- **Three door shelves**

\*See written warranty for complete details.

Not all features available on all models.

# GE Profile Arctica™ Side-By-Side Refrigerators

	GE Profile™									
	PSS29NHP PSS29NGP	PSS27SGP	PSS27NGP	PSS26SHP	PSS26NHP	PSF26NGP	PSW26SGP	PSS26SGP	PSS26NGP	PSS26MGP
Stainless steel model				●			●	●		
<b>Capacity</b>										
Total (cu. ft.)	28.7 / 28.6	26.6	26.6	25.5	25.5	25.5	25.5	25.5	25.5	25.5
Fresh food (cu. ft.)	17.92 / 17.85	16.60	16.60	16.02	16.02	16.02	16.02	16.02	16.02	16.02
Freezer (cu. ft.)	10.78	9.92	9.92	9.48	9.48	9.48	9.48	9.48	9.48	9.48
Shelf area (sq. ft.)	23.9 / 25.0	23.8	23.8	22.8	22.8	23.6	23.6	23.6	23.6	23.7
<b>Fresh Food Features</b>										
Refreshment center	● / -			●	●					
ClimateKeeper™ system	●	●	●	●	●	●	●	●	●	●
Multiflow air system	●	●	●	●	●	●	●	●	●	●
Upfront electronic digital display	●	●	●	●	●	●	●	●	●	●
Upfront electronic touch temp. controls	●	●	●	●	●	●	●	●	●	●
Electronic sensors	●	●	●	●	●	●	●	●	●	●
TurboCool™ setting	●	●	●	●	●	●	●	●	●	●
SmartWater™ filtration system	Plus	Plus	Plus	Plus	Plus	Plus	Plus	Plus	Plus	Plus
LightTouch! dispenser	Crushed Ice, Cubes, Water	Crushed Ice, Cubes, Water	Crushed Ice, Cubes, Water	Crushed Ice, Cubes, Water	Crushed Ice, Cubes, Water	Crushed Ice, Cubes, Water	Crushed Ice, Cubes, Water	Crushed Ice, Cubes, Water	Crushed Ice, Cubes, Water	Crushed Ice, Cubes, Water
Light	●	●	●	●	●	●	●	●	●	●
Child lock	●	●	●	●	●	●	●	●	●	●
Door alarm	●	●	●	●	●	●	●	●	●	●
Quick Ice™ feature	●	●	●	●	●	●	●	●	●	●
Water filter indicator light	●	●	●	●	●	●	●	●	●	●
Cabinet shelves	3 Glass	3 Glass	3 Glass	3 Glass	3 Glass	3 Glass	3 Glass	3 Glass	3 Glass	3 Glass
Adjustable	3	3	3	3	3	3	3	3	3	3
Slide-out, spillproof	2	2	2	2	2	2	2	2	2	2
QuickSpace™ shelf	●	●	●	●	●	●	●	●	●	●
Integrated shelf support system	●	●	●	●	●	●	●	●	●	●
Snugger™ clip(s)	2	2	2	2	2	2	2	2	2	2
Deli pan	Adj. Temp.	Adj. Temp.	Adj. Temp.	Adj. Temp.	Adj. Temp.	Adj. Temp.	Adj. Temp.	Adj. Temp.	Adj. Temp.	Adj. Temp.
Vegetable/fruit crisper	Adj. Humid.	Adj. Humid.	Adj. Humid.	Adj. Humid.	Adj. Humid.	Adj. Humid.	Adj. Humid.	Adj. Humid.	Adj. Humid.	Adj. Humid.
Snack pan	Sealed	Sealed	Sealed	Sealed	Sealed	Sealed	Sealed	Sealed	Sealed	Sealed
CustomCool™ technology with full-extension drawer	●	●	●	●	●	●	●	●	●	●
ClearLook™ adjustable door bins	3 (1 Adj.) 4 (3 Adj.)	4 (3 Adj.)	4 (3 Adj.)	3 (1 Adj.)	3 (1 Adj.)	4 (3 Adj.)	4 (3 Adj.)	4 (3 Adj.)	4 (3 Adj.)	4 (3 Adj.)
Dairy compartment (removable)	●	●	●	●	●	●	●	●	●	●
In-the-door beverage rack	●	●	●	●	●	●	●	●	●	●
Interior light system	Tri-level	Tri-level	Tri-level	Tri-level	Tri-level	Tri-level	Tri-level	Tri-level	Tri-level	Dual-level
Quiet Design	Premium	Premium	Premium	Premium	Premium	Premium	Premium	Premium	Premium	Premium
Automatic moisture control	●	●	●	●	●	●	●	●	●	●
NeverClean™ condenser	●	●	●	●	●	●	●	●	●	●
ENERGY STAR®				● (10%)	● (10%)	● (15%)	● (15%)	● (15%)	● (15%)	● (15%)
<b>Freezer Features</b>										
FrostGuard™ technology	●	●	●	●	●	●	●	●	●	●
Integrated Ice™ system	●	●	●	●	●	●	●	●	●	●
Wire slide-out baskets	4 (3 full-ext.)	4 (3 full-ext.)	4 (3 full-ext.)	4 (3 full-ext.)	4 (3 full-ext.)	4 (3 full-ext.)	4 (3 full-ext.)	4 (3 full-ext.)	4 (3 full-ext.)	3
Wire cabinet shelves	2	2	2	2	2	2	2	2	2	2
Wire tilt-out door bin(s)	3 (2 Adj.)	3 (2 Adj.)	3 (2 Adj.)	3 (2 Adj.)	3 (2 Adj.)	3 (2 Adj.)	3 (2 Adj.)	3 (2 Adj.)	3 (2 Adj.)	3 (2 Adj.)
Fixed door bin(s)	1	1	1	1	1	1	1	1	1	1
Interior light	Dual	Dual	Dual	Dual	Dual	Dual	Dual	Dual	Dual	Dual
<b>Exterior</b>										
Color(s) available*	WW, CC, BB	SS	WW, CC, BB	SS	WW, CC, BB	WW, CC, BB	SS	SS	WW, CC, BB	WW, CC, BB
Door handle(s)	Black Contoured Profile	Sculptured	Color-Matched Contoured Profile	Sculptured	Color-Matched Contoured Profile	Color-Matched Contoured Profile	Sculptured	Sculptured	Color-Matched Contoured Profile	Color-Matched Contoured Profile
Exterior design	Contoured	Contoured	Contoured	Contoured	Contoured	Contoured High-Gloss	Contoured	Contoured	Contoured	Contoured
Textured steel door and case	●	Case only	●	Case only	●	Case only	●	Case only	●	●
Adjustable rollers	Front	Front	Front	Front	Front	Front	Front	Front	Front	Front
<b>Weights &amp; Dimensions</b>										
Height to top of hinge (in.) A	69-1/4	69-1/4	69-1/4	69-1/4	69-1/4	69-1/4	69-1/4	69-1/4	69-1/4	69-1/4
Height to top of case (in.) B	68-3/4	68-3/4	68-3/4	68-3/4	68-3/4	68-3/4	70-1/2	68-3/4	68-3/4	68-3/4
Case depth without door(in.) C †	28	28	28	28	28	28	28-1/2	28	28	28
Case depth less door handle (in.) D †	33-9/16	32-1/4	32-1/4	32-1/4	32-1/4	32-1/4	32-3/4	32-1/4	32-1/4	32-1/4
Case depth with door handle (in.) E †	36	34-11/16	34-11/16	34-11/16	34-11/16	34-11/16	35-3/16	34-11/16	34-11/16	34-11/16
Depth w/fresh food door open 90°(in.) F †	49-11/16	50-1/16	50-1/16	50-1/16	50-1/16	50-1/16	50-9/16	50-1/16	50-1/16	50-1/16
Width (in.) G	35-3/4	35-3/4	35-3/4	35-3/4	35-3/4	35-3/4	35-7/8**	35-3/4	35-3/4	35-3/4
Width w/door open 90° less door handle (in.) H	37-3/8	36	36	36	36	36	36-3/16	36	36	36
Air clearances Each side (in.)	1/8	1/8	1/8	1/8	1/8	1/8	1/8	1/8	1/8	1/8
Top (in.)	1	1	1	1	1	1	1	1	1	1
Back (in.)	1	1	1	1	1	1	1	1	1	1
Approx. shipping weight (lbs.)	320	346	346	346	346	365	393	347	347	347
Power/Rating	120V, 60Hz, 15Amps									

\*Color(s) available: SS = Stainless steel, WW = White on white, CC = Bisque on bisque, BB = Black on black.  
 \*\*Width including caps is 36-3/16".  
 †Water hook-up fits in back air clearance when calculating installation depth.

If installed against a wall, allow clearance of 14-3/16" on 25 cu. ft., 26 cu. ft. and 27 cu. ft. models; 13" on 29 cu. ft. models on freezer side to remove ice bin. To remove fresh food pans, remove door bins. Clearances required to remove fresh food full-size pan without disassembling: 18-15/16" on 25 cu. ft., 26 cu. ft. and 27 cu. ft.; 16-1/4" on 29 cu. ft. Allow additional space for any necessary leveling adjustments.

**ALL MODELS AVAILABLE IN U.S. AND CANADA.**  
 Energy information available at [www.GEAppliances.com](http://www.GEAppliances.com)



Total volume and shelf area are calculated by the Association of Home Appliance Manufacturers' standards.



Listed by Underwriters Laboratories

## Side-By-Side Refrigerators

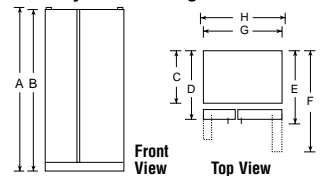

# GE Profile Arctica CustomStyle™ Side-By-Side Refrigerators

	GE Profile™									
	PSC23SHP PSC23SGP	PSH23SGP PSI23SGP	PSC23NHP	PSC23NGP	PSH23NGP PSI23NGP	PSI23SCP	PSI23NCP	PSC23MGP	PSI23MGP	
Stainless steel model	●	●				●				
<b>Capacity</b>										
Total (cu. ft.)	22.7 / 22.6	22.6	22.7	22.6	22.6	22.6	22.6	22.7	22.7	
Fresh food (cu. ft.)	14.41 / 14.38	14.38	14.41	14.38	14.38	14.38	14.38	14.38	14.38	
Freezer (cu. ft.)	8.17	8.24	8.24	8.17	8.24	8.19	8.19	8.26	8.26	
Shelf area (sq. ft.)	18.6 / 19.7	19.7	18.6	19.7	19.7	20.6	20.6	19.0	19.0	
<b>Fresh Food Features</b>										
Refreshment center	● / -		●							
ClimateKeeper system	●	●	●	●	●	●	●	●	●	
Multiflow air system	●	●	●	●	●	●	●	●	●	
Upfront electronic digital display	●	●	●	●	●	●	●	●	●	
Upfront electronic touch temp. controls	●	●	●	●	●	●	●	●	●	
Electronic sensors	●	●	●	●	●	●	●	●	●	
TurboCool setting	●	●	●	●	●	●	●	●	●	
SmartWater filtration system	Plus	Plus	Plus	Plus	Plus			Plus	Plus	
LightTouch! dispenser	Crushed Ice, Cubes, Water	Crushed Ice, Cubes, Water	Crushed Ice, Cubes, Water	Crushed Ice, Cubes, Water	Crushed Ice, Cubes, Water			Crushed Ice, Cubes, Water	Crushed Ice, Cubes, Water	
Light	●	●	●	●	●			●	●	
Child lock	●	●	●	●	●			●	●	
Door alarm	●	●	●	●	●			●	●	
Quick Ice feature	●	●	●	●	●			●	●	
Water filter indicator light	●	●	●	●	●			●	●	
Cabinet shelves	3 Glass	3 Glass	3 Glass	3 Glass	3 Glass	3 Glass	3 Glass	3 Glass	3 Glass	
Adjustable	3	3	3	3	3	3	3	3	3	
Slide-out, spillproof	2	2	2	2	2	2	2	2	2	
QuickSpace shelf	●	●	●	●	●	●	●	●	●	
Integrated shelf system	●	●	●	●	●	●	●	●	●	
Snugger clip(s)	1 / 2	2	1	2	2	2	2	2	2	
Del! pan	Adj. Temp.	Adj. Temp.	Adj. Temp.	Adj. Temp.	Adj. Temp.	Adj. Temp.	Adj. Temp.	Adj. Temp.	Adj. Temp.	
Vegetable/fruit crisper	Adj. Humid.	Adj. Humid.	Adj. Humid.	Adj. Humid.	Adj. Humid.	Adj. Humid.	Adj. Humid.	Adj. Humid.	Adj. Humid.	
Snack pan	Sealed	Sealed	Sealed	Sealed	Sealed	Sealed	Sealed	Sealed	Sealed	
CustomCool technology with full-extension drawer	●	●	●	●	●	●	●	●	●	
ClearLook adjustable door bins	3 (1 Adj.) 4 (3 Adj.)	4 (3 Adj.)	3 (1 Adj.)	4 (3 Adj.)	4 (3 Adj.)	4 (3 Adj.)	4 (3 Adj.)	4 (3 Adj.)	4 (3 Adj.)	
Dairy compartment (removable)	●	●	●	●	●	●	●	●	●	
Can storage rack (door)	● / -		●					●	●	
In-the-door beverage rack	- / ●		●					●	●	
Interior light system	Tri-level	Tri-level	Tri-level	Tri-level	Tri-level	Tri-level	Tri-level	Dual-level	Dual-level	
Quiet Design	Premium	Premium	Premium	Premium	Premium	Premium	Premium	Premium	Premium	
Automatic moisture control	●	●	●	●	●	●	●	●	●	
NeverClean condenser	●	●	●	●	●	●	●	●	●	
ENERGY STAR®		● / -			● / -					
<b>Freezer Features</b>										
FrostGuard technology	●	●	●	●	●	●	●	●	●	
Integrated Ice system	●	●	●	●	●	●	●	●	●	
Wire slide-out baskets	4 (3 full-ext.)	4 (3 full-ext.)	4 (3 full-ext.)	4 (3 full-ext.)	4 (3 full-ext.)	4 (3 full-ext.)	4 (3 full-ext.)	3	3	
Wire cabinet shelves	2 (1 slide-out)	2 (1 slide-out)	2 (1 slide-out)	2 (1 slide-out)	2 (1 slide-out)	2 (1 slide-out)	2 (1 slide-out)	2 (1 slide-out)	2 (1 slide-out)	
Wire tilt-out door bin(s)	3 (2 Adj.)	3 (2 Adj.)	3 (2 Adj.)	3 (2 Adj.)	3 (2 Adj.)	4 (3 Adj.)	4 (3 Adj.)	3 (2 Adj.)	3 (2 Adj.)	
Fixed door bins	1	1	1	1	1	1	1	1	1	
Interior light	Dual	Dual	Dual	Dual	Dual	Dual	Dual	Dual	Dual	
<b>Exterior</b>										
Color(s) available*	SS	BS	WW, CC, BB	WW, CC, BB	WW, CC, BB	BS	WW, CC, BB	WW, CC, BB	WW, CC, BB	
CustomStyle configuration	Trimless	Trimless	Trimless	Trimless	Installed Trim	Trimless	Installed Trim	Trimless	Installed Trim	
Door handles*	Sculptured	SS Full-length	CM Profile	CM Profile	CM Full-Length	SS Full-length	CM Full-Length	CM Profile	CM Full-Length	
Exterior design	Rounded Doors	Squared Doors	Rounded Doors	Rounded Doors	Squared Doors	Squared Doors	Squared Doors	Rounded Doors	Squared Doors	
Textured steel door and case	Case only	Case only	●	●	Case only	Case only	Case only	●	Case only	
Adjustable rollers	All	All	All	All	All	All	All	All	All	
<b>Weights &amp; Dimensions</b>										
Height to top of hinge (in.) A	69-1/4	69-1/4	69-1/4	69-1/4	69-1/4	69-1/4	69-1/4	69-1/4	69 1/4	
Height to top of case (in.) B	68-3/4	68-3/4	68-3/4	68-3/4	68-3/4	68-3/4	68-3/4	68-3/4	68-3/4	
Height to top of door trim (in.)		70-1/4			70-1/4	70-1/4	70-1/4	70-1/4	70-1/4	
Case depth without door (in.) C	23-7/8	23-7/8	23-7/8	23-7/8	23-7/8	23-7/8	23-7/8	23-7/8	23-7/8	
Case depth less door handle (in.) D	26-3/4	26-3/4	26-3/4	26-3/4	26-3/4	26-3/4	26-3/4	26-3/4	26 3/4	
Case depth with door handle (in.) E	29-3/16	28-5/16	29-3/16	29-3/16	28-5/16	28-5/16	28-5/16	29-3/16	28-5/16	
Depth w/fresh food door open 90° (in.) F	45-9/16	45-9/16	45-9/16	45-9/16	45-9/16	45-9/16	45-9/16	45-9/16	45-9/16	
Width (in.) G	35-3/4	35-3/4	35-3/4	35-3/4	35-3/4	35-3/4	35-3/4	35-3/4	35-3/4	
Width w/door open 90° w/door handle (in.) H	38-3/16	37-5/16	38-3/16	38-3/16	37-5/16	37-5/16	37-5/16	38-3/16	37-5/16	
Air clearances Each side (in.)	1/8	1/8	1/8	1/8	1/8	1/8	1/8	1/8	1/8	
Top (in.)	1	1	1	1	1	1	1	1	1	
Back (in.)	1/2	1/2	1/2	1/2	1/2	1/2	1/2	1/2	1/2	
Approx. shipping weight (lbs.)	334	334	334	334	334	334	334	334	334	
Power/Rating	120V, 60Hz, 15Amps									
<b>Accessories</b>										
Factory trim kit attached	N/A	N/A	N/A	N/A	●	N/A	●	N/A	●	
Black acrylic panels (optional)	N/A	N/A	N/A	N/A	PSPK23DBB	N/A	PSPK23CBB	N/A	PSPK23DBB	
White acrylic panels (optional)	N/A	N/A	N/A	N/A	PSPK23DWW	N/A	PSPK23GWW	N/A	PSPK23DWW	
Bisque acrylic panels (optional)	N/A	N/A	N/A	N/A	PSPK23DCC	N/A	PSPK23CCC	N/A	PSPK23DCC	
Stainless steel panels (optional)	N/A	N/A	N/A	N/A	PSPK23DSS	N/A	N/A	N/A	PSPK23DSS	
Black collar trim (optional)	N/A	TRMBISBB	N/A	N/A	TRMBISBB	TRMBISBB	TRMBISBB	N/A	TRMBISBB	
White collar trim (optional)	N/A	TRMBISWW	N/A	N/A	TRMBISWW	TRMBISWW	TRMBISWW	N/A	TRMBISWW	
Bisque collar trim (optional)	N/A	TRMBISCC	N/A	N/A	TRMBISCC	TRMBISCC	TRMBISCC	N/A	TRMBISCC	
Stainless steel collar trim (optional)	N/A	TRMBISSS	N/A	N/A	TRMBISSS	TRMBISSS	TRMBISSS	N/A	TRMBISSS	

\*Color(s) available: BS = Black case with stainless steel doors, SS = Stainless steel, WW = White on white, CC = Bisque on bisque, BB = Black on black, CM = Color-Matched. If installed against a wall, allow clearance of 13-15/16" on freezer side to remove bin. Clearance required to remove fresh food full size pan without disassembling is 18-5/8".

**ALL MODELS AVAILABLE IN U.S. AND CANADA.**

# GE Profile Arctica CustomStyle™ Side-By-Side Installation Information and Specifications

## Rough-In Dimensions

### Standard, New Construction and Replacement Installation

#### Installation Tips to Maximize the Built-In Look

- All wall/floor molding should be removed prior to installation.
- Water recess on rear wall recommended to prevent water line damage. 48" minimum length, 1/4" diameter water line tubing recommended.
- When possible, recess both copper water line and electrical outlet. (See local codes)
- Front and rear leveling legs are adjustable for the built-in look. (See owner's manual)
- If optional collar trim kit is to be used or anticipated, see collar trim installation on next page for different rough-in dimensions.

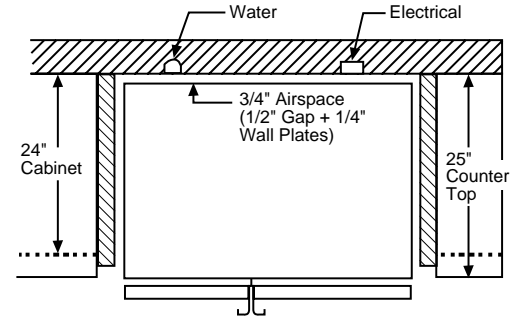
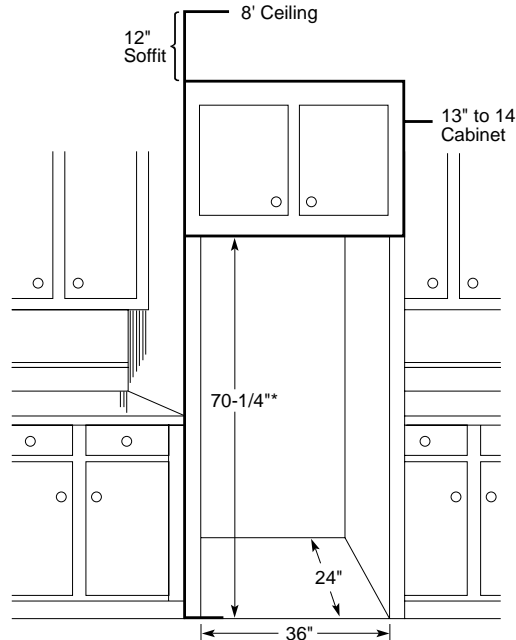

\*The rough-in dimension of 70-1/4" is minimum and is measured from the finished floor to top of opening (or the underside of the overhead cabinets). For Models with Trim Kit: If frameless style cabinets are planned for above the refrigerator, you may need to consider adding a maximum of 1/4" (70-1/2") to height of opening to allow additional clearance between cabinet doors and top of refrigerator trim when cabinet doors are in open position.

## Door Panel Dimensions

### Freezer Panel without Dispenser

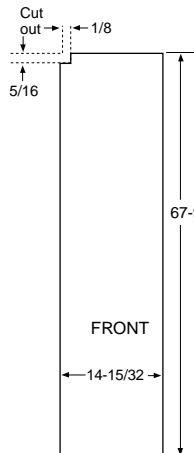

### Freezer Panel with Dispenser

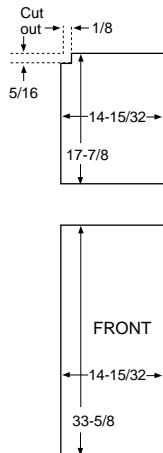

### Fresh Food Panel

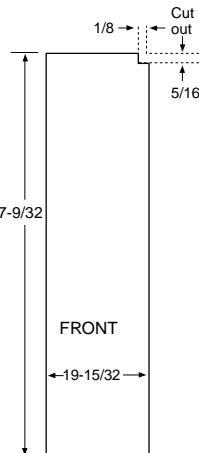

### Order your own custom wood panels to match cabinetry or other decor.

Panels up to 1/4" thick will fit door frame with no special preparation. Add filler behind material thinner than 1/4" for proper fit.

**Weight Limits:** Total weight of panels (i.e., both freezer panels)— Fresh Food = 38 lbs., Freezer = 28 lbs.

**Note:** Panels up to 3/4" will require special routing area around handles. Dimensions may vary depending on depth of panel.

### Detail C

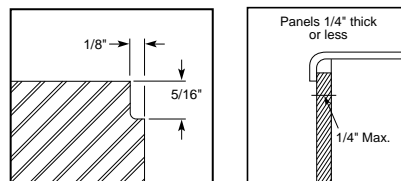

(Fresh Food panel shown)  
Notch required at top corner as noted.

## Installation of Water Outlets

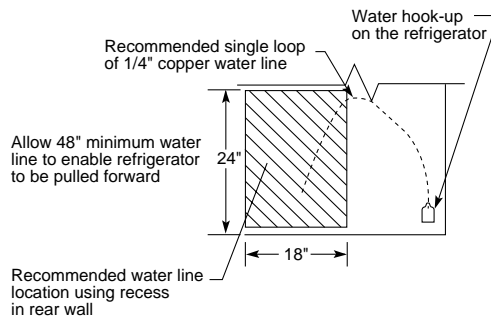
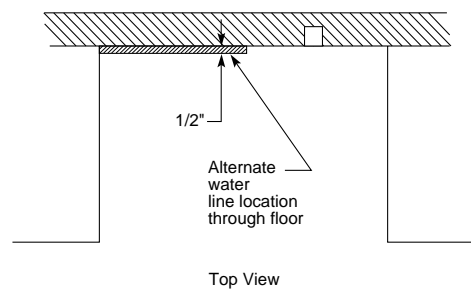

**IMPORTANT:** Before finalizing specifications for your GE Profile CustomStyle Refrigerator, please NOTE:

- A minimum of 36" is required for refrigerator installation
- Be sure to allow for 1/2" or 3/4" side panels in addition to the 36" minimum

## Collar Trim Installation

An enclosure is **required** to match up to the trim, see Typical Installation. To obtain the most integrated look, the cabinet or soffit above the refrigerator should extend out to the same depth as the side panels. The refrigerator opening must have minimum dimensions of 70-1/4" high x 36-1/8" wide x 24-1/2" deep as shown at right. If there is an overhead cabinet, allow 1" for cabinet door clearance with the top trim piece so the cabinet doors can be opened without hitting the top trim. If 1/2" side panels are used, then side trim and panel will be even. If 3/4" side panels are used, then some of the side panel will extend beyond the trim and must be finished.

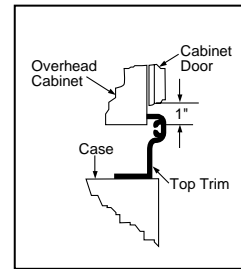
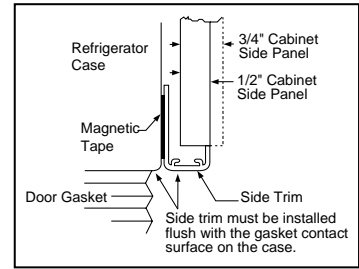
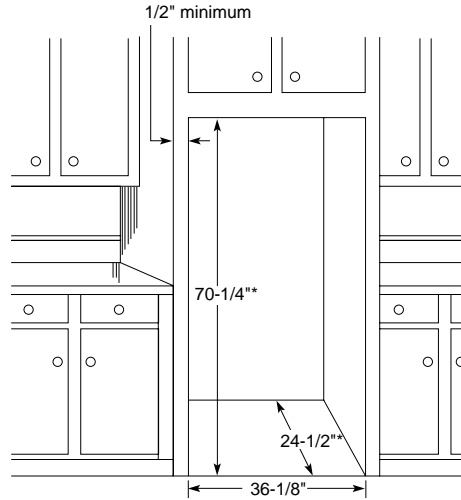

\*The rough-in dimension of 70-1/4" is minimum and is measured from the finished floor to top of opening (or the underside of the overhead cabinets). For Models with Trim Kit: If frameless style cabinets are planned for above the refrigerator, you may need to consider adding a maximum of 1/4" (70-1/2") to height of opening to allow additional clearance between cabinet doors and top of refrigerator trim when cabinet doors are in open position.

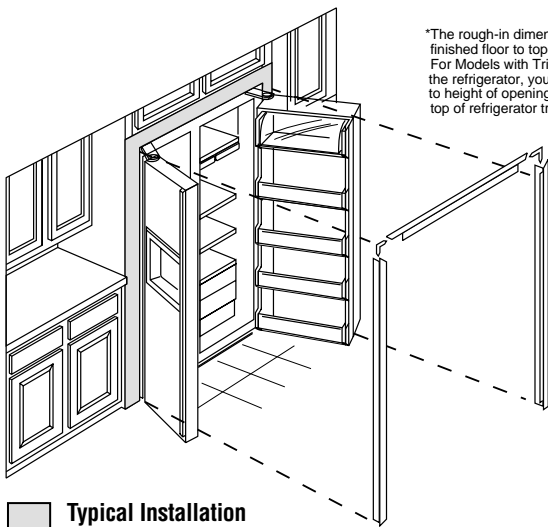

### Typical Installation

Shaded areas represent front surfaces of side panels and overhead cabinet or soffit that contacts trim.

**IMPORTANT:** Before finalizing specifications for your GE Profile CustomStyle Refrigerator, please NOTE:

- A minimum of 36-1/8" is required for refrigerator installation with collar
- Be sure to allow for 1/2" or 3/4" side panels in addition to the 36-1/8" minimum

## Create a Custom Look for Your GE Profile CustomStyle Side-By-Side Refrigerator

Still another advantage offered by GE Profile CustomStyle Refrigerators is ease of installation. For a refrigerator that does so much to enhance the beauty of your kitchen, the "behind-the-scenes" preparation and installation are surprisingly simple.

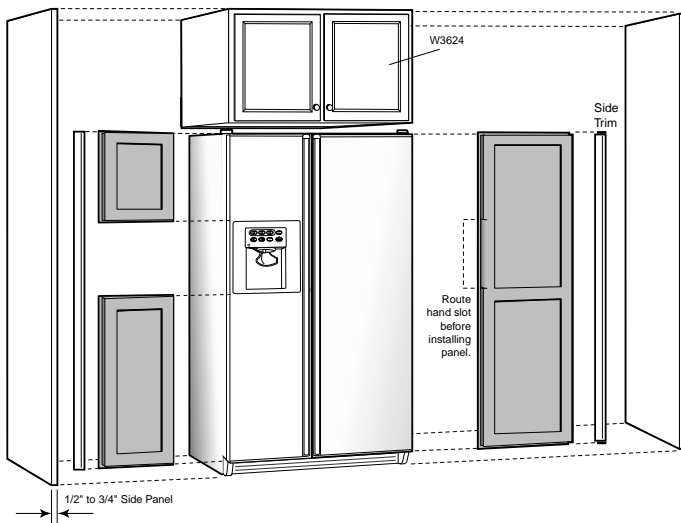

### Fabricating the Enclosure

- The drawing shows an 84" cabinet elevation. Adjust dimensions accordingly for other cabinet elevations.
- Cabinet pieces to order: (2) side panels and (1) wall cabinet.
- Side panels will typically be attached to adjacent cabinets and/or cleated to rear wall and floor.
- Refer to GE refrigerator installation instructions for proper plumbing, and electrical and air clearances.
- (1) Some framed cabinet lines will make a refrigerator enclosure with a cabinet 12" high x 39" wide with sides and 1-1/2" face frame extended down to floor to create the refrigerator space. This will replace the above construction.
- (2) A tall cabinet on either side of the refrigerator can replace a side panel!
- Counter overhangs on either side of the refrigerator should have clipped corners to allow for full door swing.
- If the refrigerator has a wall returning beyond the front of the refrigerator on either side, a 2" tall filler will help to allow for movement of the door.

### Door Panels

- See drawings for exact dimensions of the fresh-food and freezer door panels.
- Refrigerator door fronts from stock and most semi-custom cabinet manufacturers will be supplied as 1/4"-thick panels cut to dimensions, with closest available standard door sizes applied to front.
  - This will leave a "reveal" at top/bottom and sides.
  - Width of "reveal" will depend on manufacturer's standard door sizes.
  - Door will be affixed on the 1/4" panels at factory or in the field by the local supplier, depending on manufacturer.
- Local shop-built or custom cabinet supplier may fabricate custom 3/4" panels. In this case, edges must be routed.
- Follow notes on drawing to assure room for fingers/hands to open handles.

# GE® Side-By-Side Refrigerators

	GE "L" Series	GE "S" Series		GE "K" Series		GE "J" Series		
	GSS25LSP GSS25LGP	GSS25SGP GSH25SGP	GSS22SGP GSH22SGP	GSS25KGP GSH25KGP	GSS22KGP GSH22KGP	GSL25JFP GSS25JFP GSH25JFP	GSL22JFP GSS22JFP GSH22JFP	GSS25JEP GSS22JEP
Stainless steel model	● / -	●						
<b>Capacity</b>								
Total (cu. ft.)	25.4	24.9	21.8	24.9	21.8	24.9	21.8	24.9 / 21.8
Fresh food (cu. ft.)	15.90	15.33	14.70	15.33	14.70	15.33	14.70	15.33 / 14.70
Freezer (cu. ft.)	9.48	9.53	7.11	9.53	7.11	9.53	7.11	9.53 / 7.11
Shelf area (sq. ft.)	23.7	24.1	7.11	24.1	22.1	22.4	20.4	22.4 / 20.4
<b>Fresh Food Features</b>								
SmartWater™ filtration system	Plus	Plus	Plus	Plus	Plus	●	●	
LightTouch! dispenser features	Crushed Ice, Cubes, Water	Crushed Ice, Cubes, Water	Crushed Ice, Cubes, Water	Crushed Ice, Cubes, Water	Crushed Ice, Cubes, Water	Crushed Ice, Cubes, Water	Crushed Ice, Cubes, Water	Crushed Ice, Cubes, Water
Light	●	●	●	●	●	●	●	●
Child lock	●	●	●	●	●			
Door alarm	●							
Water filter indicator light	●	●	●	●	●			
Upfront electronic touch temperature controls	●			●	●			
Upfront electronic temperature controls				●	●			
Cabinet shelves	3 Glass	3 Glass	3 Glass	3 Glass	3 Glass	3 Glass	3 Glass	3 Glass
Adjustable	3	3	3	3	3	3	3	3
Slide-out	2	2	2	2	2			
Spillproof	2	2	2	2	2	●	●	●
QuickSpace™ shelf	●	●	●	●	●			
Integrated shelf system	●							
TurboCool™ setting	●							
Snuggler™ clip	1	1	1	1	1			
Deli pan	1 Sealed	1 Adj. Temp.	1 Adj. Temp.	1 Adj. Temp.	1 Adj. Temp.	1 Adj. Temp.	1 Adj. Temp.	1 Adj. Temp.
Vegetable/fruit crisper	1 Adj. Humid.	1 Adj. Humid.	1 Adj. Humid.	1 Adj. Humid.	1 Adj. Humid.	1 Sealed	1 Sealed	1 Sealed
Snack pan	●	●	●	●	●			
Adjustable door bins	4 (3 Adj. w/ gallon storage)	4 (2 Adj. w/ gallon storage)	4 (2 Adj. w/ gallon storage)	4 (2 Adj. w/ gallon storage)	4 (2 Adj. w/ gallon storage)	4 (2 Adj. w/ gallon storage)	4 (2 Adj. w/ gallon storage)	4 (2 Adj. w/ gallon storage)
Dairy compartment	●	●	●	●	●	●	●	●
Utility bin (clear)	●	●	●	●	●			
Interior light system	Dual-level	Dual-level	Dual-level	Dual-level	Dual-level	Dual-level	Dual-level	Single
Quiet Design	Deluxe	Deluxe	Deluxe	Deluxe	Deluxe	Deluxe	Deluxe	Deluxe
Automatic moisture control	●	●	●	●	●	●	●	●
NeverClean™ condenser	●	●	●	●	●	●	●	●
ENERGY STAR®	●	- / ●	- / ●	- / ●	- / ●	- / - / ●	- / - / ●	
<b>Freezer Features</b>								
Integrated Ice™ system	●							
FrostGuard™ technology	●	●	●	●	●	●	●	●
Factory-installed electronic icemaker & bin	●	●	●	●	●	●	●	●
Wire cabinet shelves	2 (1 slide-out)	4 (3 Adj.)	4 (3 Adj.)	4 (3 Adj.)	4 (3 Adj.)	4 (3 Adj.)	4 (3 Adj.)	4 (3 Adj.)
Storage basket(s)	3 wire (slide-out)	1 wire (slide-out)	1 wire (slide-out)	1 wire (slide-out)	1 wire (slide-out)	1 bin	1 bin	1 bin
Door shelves	3 (2 Adj.)	5	5	5	5	5	5	5
Interior light	●	●	●	●	●	●	●	●
<b>Appearance</b>								
Color(s) available*	BS / WW, CC, BB	SS	SS	WW, CC, BB	WW, CC, BB	CleanSteel™/WW, CC	CleanSteel™/WW, CC	WW, CC, BB
Deluxe door handle(s)*	Black Premium/CM	Stainless Steel	Stainless Steel	CM Premium	CM Premium	CM Premium	CM Premium	CM Premium
Textured steel door and case	Case only / ●	Case only	Case only	●	●	●	●	●
Adjustable rollers	Front	Front	Front	Front	Front	Front	Front	Front
<b>Weights &amp; Dimensions</b>								
Height to top of hinge (in.) A	69-1/4	69-3/4	67-1/2	69-3/4	67-1/2	69-3/4	67-1/2	69-3/4 / 67-1/2
Height to top of case (in.) B	68-3/4	68-3/4	66-1/2	68-3/4	66-1/2	68-3/4	66-1/2	68-3/4 / 66-1/2
Case depth without door (in.) C†	28	28	28	28	28	28	28	28
Case depth less door handle (in.) D†	31-1/4	31-1/4	31-1/4	31-1/4	31-1/4	31-1/4	31-1/4	31-1/4
Case depth with door handle (in.) E†	33-9/16	33-9/16	33-9/16	33-9/16	33-9/16	33-9/16	33-9/16	33-9/16
Depth with fresh food door open 90° (in.) F†	50-1/16	49-3/8	49-3/8	49-3/8	49-3/8	49-3/8	49-3/8	49-3/8
Width (in.) G	35-3/4	35-3/4	33-1/2	35-3/4	33-1/2	35-3/4	33-1/2	35-3/4 / 33-1/2
Width w/door open 90° less door handle (in.) H	36	35-3/4	33-1/2	35-3/4	33-1/2	35-3/4	33-1/2	35-3/4 / 33-1/2
Air clearances Each side (in.)	1/8	1/8	1/8	1/8	1/8	1/8	1/8	1/8
Top (in.)	1	1	1	1	1	1	1	1
Back (in.)	1	1	1	1	1	1	1	1
Approx. shipping weight (lbs.)	338	338	334	338	315	338	315	338 / 315
Power/Ratings	120V, 60Hz, 15Amps							

\*Color(s) available: BS = Black case with stainless steel doors, SS = Stainless steel, WW = White on white, CC = Bisque on bisque, BB = Black on black, CM = Color-Matched.

†Water hook-up fits in back air clearance when calculating installation depth.

If installed against a wall, allow clearance of 10-3/4" on 20 cu. ft. and 22 cu. ft. models; 14-3/16" on 25 cu. ft. models on freezer side to remove bin.

Clearances required to remove fresh food full-size pan without disassembling: 13-1/2" on 20 cu. ft.; 15" on 22 cu. ft.; and 18-15/16" on 25 cu. ft.

Allow additional space for any necessary leveling adjustments.

**ALL MODELS AVAILABLE IN U.S. AND CANADA.**



Total volume and shelf area are calculated by the Association of Home Appliance Manufacturers' standards.



Listed by Underwriters Laboratories

## Side-By-Side Refrigerators

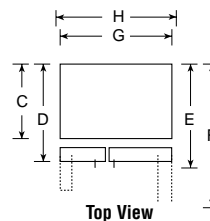
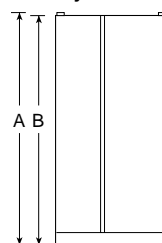

	GE "I" Series		GE "D" Series
	GSS22IBP GSS20IBP	GSS20IEP	GSS20DBP
<b>Capacity</b>			
Total (cu. ft.)	21.8 / 19.84	19.94	19.84
Fresh food (cu. ft.)	14.84 / 12.87	12.75	12.75
Freezer (cu. ft.)	7.04	7.14	7.04
Shelf area (sq. ft.)	21.1 / 18.0	17.3	18.1
<b>Fresh Food Features</b>			
LightTouch! dispenser features		Crushed Ice, Cubes, Water	
Light		●	
Upfront electronic temperature controls	●	●	●
Cabinet shelves	3 Glass	3 Glass	3 Wire Everwhite
Adjustable	3	3	3
Deli pan	1 Sealed	1 Adj. Temp.	1 Sealed
Vegetable/fruit crisper	1 Sealed	1 Sealed	1 Sealed
Adjustable door bins	4 (2 Adj. w/ gallon storage)	4 (2 w/ gallon storage)	4 (2 w/ gallon storage)
Dairy compartment	●	●	●
Interior light system	Single-level	Single-level	Single-level
Quiet Design	Deluxe	Deluxe	Deluxe
Automatic moisture control	●	●	●
NeverClean condenser	●	●	●
<b>Freezer Features</b>			
FrostGuard technology	●	●	●
Factory-installed electronic icemaker & bin	Opt. (IM5SS)	●	Opt. (IM5SS)
Wire cabinet shelves	5 (4 Adj.) 4 (3 Adj.)	3 (2 Adj.)	4 (3 Adj.)
Storage bin(s)	1	1	1
Door shelves	6	5	6
Interior light	●	●	●
<b>Appearance</b>			
Color(s) available*	WW, CC	WW, CC, WH	WW, CC
Deluxe door handle(s)*	CM	WW, CC, BK	CM
Textured steel door and case	●	●	●
Adjustable rollers	Front	Front	Front
<b>Weights &amp; Dimensions</b>			
Height to top of hinge (in.) A	67-1/2	67-1/2	67-1/2
Height to top of case (in.) B	66-1/2	66-1/2	66-1/2
Case depth without door (in.) C†	28	28	28
Case depth less door handle (in.) D‡	31-1/4	31-1/4	31-1/4
Case depth with door handle (in.) E‡	33-9/16	33-9/16	33-9/16
Depth with fresh food door open 90° (in.) F‡	49-3/8 / 47-3/8	47-3/8	47-3/8
Width (in.) G	33-1/2 / 31-1/2	31-1/2	31-1/2
Width w/door open 90° less door handle (in.) H	33-5/8 / 31-5/8	31-5/8	31-5/8
Air clearances Each side (in.)	1/8	1/8	1/8
Top (in.)	1	1	1
Back (in.)	1	1	1
Approx. shipping weight (lbs.)	315 / 300	300	300
Power/Ratings	120V, 60Hz, 15Amps		

\*Color(s) available: WW = White on white, CC = Bisque on bisque, WH = White, BK = Black, CM = Color-Matched.

†Water hook-up fits in back air clearance when calculating installation depth.

If installed against a wall, allow clearance of 10-3/4" on 20 cu. ft. and 22 cu. ft. models;

14-3/16" on 25 cu. ft. models on freezer side to remove bin.

To remove fresh food pans, remove door bins.

Clearances required to remove fresh food full-size pan without disassembling:

13-1/2" on 20 cu. ft.; 15" on 22 cu. ft.; and 18-15/16" on 25 cu. ft.

Allow additional space for any necessary leveling adjustments.

**ALL MODELS AVAILABLE IN U.S. AND CANADA.**

**Side-By-Side Refrigerators**

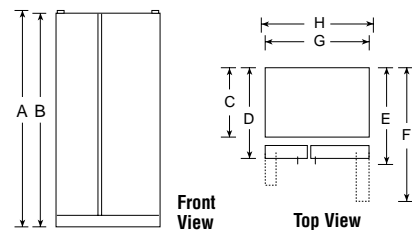

# GE Profile Arctica™ Top-Freezer Refrigerators

	GE Profile Arctica					
	PTS25LHP	PTS25SHP	PTS22LHP	PTS22SHP	PTS22LCP	PTS22SCP
Stainless steel model		●		●		●
<b>Capacity</b>						
Total (cu. ft.)	24.6	24.6	21.7	21.7	21.7	21.7
Fresh food (cu. ft.)	17.51	17.51	15.35	15.35	15.35	15.35
Freezer (cu. ft.)	7.08	7.08	6.35	6.35	6.35	6.35
Shelf area (sq. ft.)	29.1	29.1	26.3	26.3	26.3	26.3
<b>Fresh Food Features</b>						
Internal water dispenser	●	●	●	●		
ClimateKeeper™ system	●	●	●	●	●	●
Multiflow air system	●	●	●	●	●	●
Upfront electronic touch temperature controls	●	●	●	●	●	●
Electronic sensors	●	●	●	●	●	●
GE SmartWater™ filtration	●	●	●	●		
Cabinet shelves	4 Glass	4 Glass	4 Glass	4 Glass	4 Glass	4 Glass
Adjustable	4 Split	4 Split	4 Split	4 Split	4 Split	4 Split
Slide-out, removable	3	3	3	3	3	3
Spillproof	4	4	4	4	4	4
ShelfSaver™ rack	●	●	●	●	●	●
Delicacy pan	Adj. Temp.	Adj. Temp.	Adj. Temp.	Adj. Temp.	Adj. Temp.	Adj. Temp.
Vegetable/fruit crisper(s)	2 Adj. Humid.	2 Adj. Humid.	2 Adj. Humid.	2 Adj. Humid.	2 Adj. Humid.	2 Adj. Humid.
Pivot-out pan removal system	●	●	●	●	●	●
ClearLook™ adjustable gallon door bins	4 (Adj.)	4 (Adj.)	4 (Adj.)	4 (Adj.)	4 (Adj.)	4 (Adj.)
Snugger™ clip(s)	2	2	2	2	2	2
Fixed door bins	1 (Tall Bottle)	1 (Tall Bottle)	1 (Tall Bottle)	1 (Tall Bottle)	1 (Tall Bottle)	1 (Tall Bottle)
Dairy compartment	●	●	●	●	●	●
Interior light system	Dual	Dual	Dual	Dual	Dual	Dual
Quiet Design	Premium	Premium	Premium	Premium	Premium	Premium
Automatic moisture control	●	●	●	●	●	●
NeverClean™ condenser	●	●	●	●	●	●
ENERGY STAR®	●	●	●	●	●	●
<b>Freezer Features</b>						
Factory-installed electronic icemaker and bin	●	●	●	●	●	●
Multiflow air system (freezer)	●	●	●	●	●	●
Ice storage bin	Ice Bucket	Ice Bucket	Ice Bucket	Ice Bucket	Ice Bucket	Ice Bucket
FrostGuard™ technology	●	●	●	●	●	●
Spillproof freezer floor	●	●	●	●	●	●
Wire freezer compartment shelves	1 full-width (2 pos.)	1 full-width (2 pos.)	1 full-width (2 pos.)	1 full-width (2 pos.)	1 full-width (2 pos.)	1 full-width (2 pos.)
Freezer door bins	2 (1 Adj.)	2 (1 Adj.)	2 (1 Adj.)	2 (1 Adj.)	2 (1 Adj.)	2 (1 Adj.)
Tilt-out locking freezer door bin	●	●	●	●	●	●
Interior light	●	●	●	●	●	●
<b>Exterior</b>						
Color(s) available*	WW, CC, BB	BS	WW, CC, BB	BS	WW, CC, BB	BS
Deluxe door handle(s)	Color-Matched	Black	Color-Matched	Black	Color-Matched	Black
Customer installed handles	●	●	●	●	●	●
Exterior design	Rounded Doors	Rounded Doors	Rounded Doors	Rounded Doors	Rounded Doors	Rounded Doors
Reversible doors	●	●	●	●	●	●
Adjustable rollers	Front	Front	Front	Front	Front	Front
<b>Weights &amp; Dimensions</b>						
Height to top of hinge (in.) A	68-5/8	68-5/8	67-1/2	67-1/2	67-1/2	67-1/2
Height to top of case (in.) B	67-7/8	67-7/8	66-7/8	66-7/8	66-7/8	66-7/8
Case depth without door (in.) C	27-5/8	27-5/8	27-5/8	27-5/8	66-7/8	66-7/8
Case depth less door handle (in.) D	31-5/8	31-5/8	31-5/8	31-5/8	31-5/8	31-5/8
Case depth with door handle (in.) E	33-5/8	33-5/8	33-5/8	33-5/8	33-5/8	33-5/8
Depth with fresh food door open 90° (in.) F	66	66	63	63	63	63
Width (in.) G	35 7/8	35-7/8	32-7/8	32-7/8	32-7/8	32-7/8
Width w/door open 90° less door handle (in.) H	36	36	33	33	33	33
Air clearances Each side (in.)	1/8	1/8	1/8	1/8	1/8	1/8
Top (in.)	1	1	1	1	1	1
Back (in.)	1	1	1	1	1	1
Approx. shipping weight (lbs.)	310	310	260	260	260	260
Power/Ratings	120V, 60Hz, 15Amps					

\*Color(s) available: BS = Black case with stainless steel doors, WW = White on white, CC = Bisque on bisque, BB = Black on black.

ALL MODELS AVAILABLE IN U.S. AND CANADA.

## Top-Freezer No-Frost Refrigerators

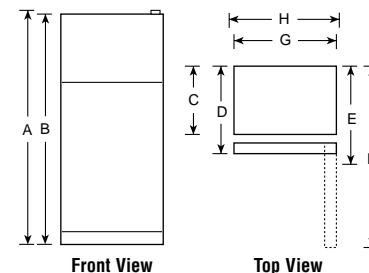

Total volume and shelf area are calculated by the Association of Home Appliance Manufacturers' standards.



Listed by Underwriters Laboratories

# GE Profile CustomStyle™ Top-Freezer Refrigerators

	GE Profile™						
	PTC22MBM	PTC22MFM	PTC22SBM	PTC22SFM	PTI22MBM	PTI22MFM	PTI22SFM
Stainless steel model			●	●			●
<b>Capacity</b>							
Total (cu. ft.)	21.9	21.7	21.9	21.7	21.9	21.7	21.7
Fresh food (cu. ft.)	15.4	15.4	15.4	15.4	15.4	15.4	15.4
Freezer (cu. ft.)	6.5	6.3	6.5	6.3	6.5	6.3	6.3
Shelf area (sq. ft.)	22.4	20	22.4	20	22.4	20	20
<b>Fresh Food Features</b>							
SmartWater™ filtration system		●		●		●	●
		Crushed Ice, Cubes, Water		Crushed Ice, Cubes, Water		Crushed Ice, Cubes, Water	Crushed Ice, Cubes, Water
LightTouch! dispenser							
Upfront illuminated temperature controls	●	●	●	●	●	●	●
Cabinet shelves	4 Glass	4 Glass	4 Glass	4 Glass	4 Glass	4 Glass	4 Glass
Adjustable	4 Split	4 Split	4 Split	4 Split	4 Split	4 Split	4 Split
Slide-out, spillproof	3	3	3	3	3	3	3
Snugger clip	●	●	●	●	●	●	●
QuickSpace™ shelf	●	●	●	●	●	●	●
Meat pan	Adj. Temp.	Adj. Temp.	Adj. Temp.	Adj. Temp.	Adj. Temp.	Adj. Temp.	Adj. Temp.
Vegetable/fruit crisper(s)	2 Adj. Humid.	2 Adj. Humid.	2 Adj. Humid.	2 Adj. Humid.	2 Adj. Humid.	2 Adj. Humid.	2 Adj. Humid.
Slide-out, spillproof crisper cover	●	●	●	●	●	●	●
ClearLook modular door bins	4 Adj. w/gallon storage	4 Adj. w/gallon storage	4 Adj. w/gallon storage	4 Adj. w/gallon storage	4 Adj. w/gallon storage	4 Adj. w/gallon storage	4 Adj. w/gallon storage
Fixed door bins	1 F/W tall bottle	1 F/W tall bottle	1 F/W tall bottle	1 F/W tall bottle	1 F/W tall bottle	1 F/W tall bottle	1 F/W tall bottle
Slide-out, slide-over pan removal system	●	●	●	●	●	●	●
Dairy compartment	●	●	●	●	●	●	●
Beverage rack	●	●	●	●	●	●	●
Interior light system	Dual	Dual	Dual	Dual	Dual	Dual	Dual
Quiet Design	Deluxe	Deluxe	Deluxe	Deluxe	Deluxe	Deluxe	Deluxe
Automatic moisture control	●	●	●	●	●	●	●
NeverClean condenser	●	●	●	●	●	●	●
ENERGY STAR®		●		●		●	●
<b>Freezer Features</b>							
Factory-installed electronic icemaker & bin	Opt. (IM4A)	●	Opt. (IM4A)	●	Opt. (IM4A)	●	●
Ice 'N Easy trays	3		3		3		
Ice storage bin	●		●		●		
Wire compartment shelf(s)	2 Split (Adj.)	1(Adj.) 2 fixed	2 Split (Adj.)	1(Adj.) 2 fixed	2 Split (Adj.)	1(Adj.) 2 fixed	1(Adj.) 2 fixed
Door bins	2 Adj./1 F/W fixed	(1 w/gallon storage)	2 Adj./1 F/W fixed	(1 w/gallon storage)	2 Adj./1 F/W fixed	(1 w/gallon storage)	(1 w/gallon storage)
Interior light		●		●		●	●
<b>Exterior</b>							
Color(s) available*	WW, BB	WW, CC, BB	BS	BS	WW, BB	WW, BB	BS
CustomStyle configuration	Trimless	Trimless	Trimless	Trimless	Installed Trim	Installed Trim	Installed Trim
Premium door handles*	CM Deluxe	CM Deluxe	Black Deluxe	Black Deluxe	CM Full-Length	CM Full-Length	Stainless Steel Appearance
Choose right or left door opening	●	●	●	●	●	●	●
Reversible doors	●						
Exterior design	Rounded Doors	Rounded Doors	Rounded Doors	Rounded Doors	Squared Doors	Squared Doors	Squared Doors
Adjustable rollers	All	All	All	All	All	All	All
<b>Weights &amp; Dimensions</b>							
Height to top of hinge (in.) A	69-7/8	69-7/8	69-7/8	69-7/8	69-7/8	69-7/8	69-7/8
Height to top of case (in.) B	68-3/4	68-3/4	68-3/4	68-3/4	68-3/4	68-3/4	68-3/4
Height to top of door trim (in.)					70-1/2	70-1/2	70-1/2
Case depth without door (in.) C	23-3/4	23-3/4	23-3/4	23-3/4	23-3/4	23-3/4	23-3/4
Depth less door handle (in.) D	26-3/4	26-3/4	26-3/4	26-3/4	26-3/4	26-3/4	26-3/4
Depth with door handle (in.) E	28-5/8	28-5/8	28-5/8	28-5/8	28-3/8	28-3/8	28-5/8
Depth with fresh food door open 90° (in.) F	61	61	61	61	61	61	61
Width (in.) G	35-3/4	35-3/4	35-3/4	35-3/4	35-3/4	35-3/4	35-3/4
Width with door open 90° w/door handle (in.) H	38-1/4	38-1/4	38-1/4	38-1/4	38	38	38
Air clearances Each side (in.)	1/8	1/8	1/8	1/8	1/8	1/8	1/8
Top (in.)	1	1	1	1	1	1	1
Back (in.)	1/2	1/2	1/2	1/2	1/2	1/2	1/2
Approx. shipping weight (lbs.)	300	324	300	324	300	324	360
Power/Ratings	120V, 60Hz, 15Amps						
<b>Accessories</b>							
Black acrylic panels (optional)	N/A	N/A	N/A	N/A	PTPK22CBB	PTPK22DBB	N/A
White acrylic panels (optional)	N/A	N/A	N/A	N/A	PTPK22CWW	PTPK22DWW	N/A
Stainless steel panels (optional)	N/A	N/A	N/A	N/A	PTPK22CSS	PTPK22DSS	N/A
Black collar trim (optional)	N/A	N/A	N/A	N/A	TRMBISBB	TRMBISBB	N/A
White collar trim (optional)	N/A	N/A	N/A	N/A	TRMBISWW	TRMBISWW	N/A
Bisque collar trim (optional)	N/A	N/A	N/A	N/A	N/A	N/A	N/A
Stainless steel collar trim (optional)	N/A	N/A	N/A	N/A	TRMBISSS	TRMBISSS	TRMBISSS

\*Color(s) available: BS = Black case with stainless steel doors, WW = White on white, CC = Bisque on bisque, BB = Black on black, CM = Color-Matched.

ALL MODELS AVAILABLE IN U.S. AND CANADA.

# GE Profile CustomStyle™ Top-Freezer Installation Information and Specifications

## Rough-In Dimensions

### Standard, New Construction and Replacement Installation

#### Installation Tips to Maximize the Built-In Look

- All wall/floor molding should be removed prior to installation.
- Water recess on rear wall recommended to prevent water line damage. 48" minimum length, 1/4" diameter water line tubing recommended.
- When possible, recess both copper water line and electrical outlet. (See local codes)
- Front and rear leveling legs are adjustable for the built-in look. (See owner's manual)

### Collar Trim Installation

An enclosure is **required** to match up to the trim, see Typical Installation. To obtain the most integrated look, the cabinet or soffit above the refrigerator should extend out to the same depth as the side panels. The refrigerator opening must have minimum dimensions of 70-1/4" high x 36-1/8" wide x 24-1/2" deep as shown at right. If there is an overhead cabinet, allow 1" for cabinet door clearance with the top trim piece so the cabinet doors can be opened without hitting the top trim. If 1/2" side panels are used, then side trim and panel will be even. If 3/4" side panels are used, then some of the side panel will extend beyond the trim and must be finished.

Rough-In Dimensions

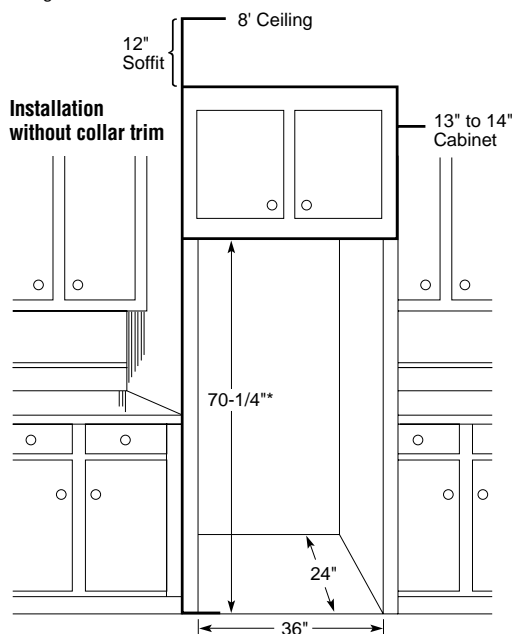

Collar Trim Installation

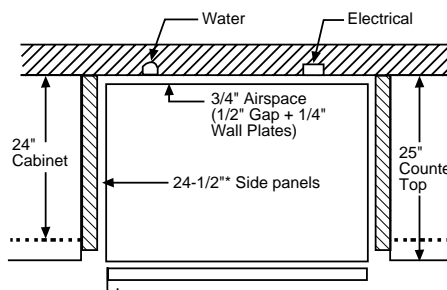
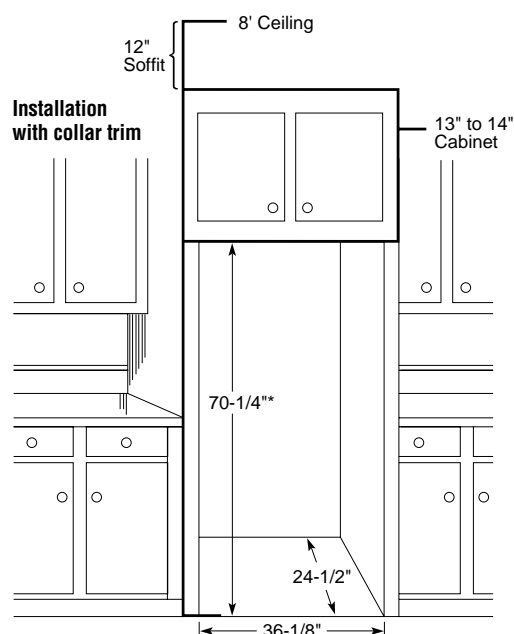

\*The rough-in dimension of 70-1/4" is minimum and is measured from the finished floor to top of opening (or the underside of the overhead cabinets). For Models with Trim Kit: If frameless style cabinets are planned for above the refrigerator, you may need to consider adding a maximum of 1/4" (70-1/2") to height of opening to allow additional clearance between cabinet doors and top of refrigerator trim when cabinet doors are in open position.

For 22 cu. ft. models only.

\*22" depth applies to the refrigerator opening, not the actual cabinet depth.

## Door Panel Dimensions

Order your own custom wood panels to match cabinetry or other decor.

Fresh Food Panels	Freezer Panel Without Dispenser	Freezer Panel With Dispenser
B-42-1/4"	A-24-1/16"	D-24-1/16"
22 cu. ft. C-35-3/4"	C-35-3/4"	C-35-3/4"

Panels up to 1/4" thick will fit door frame with no special preparation. Add filler behind material thinner than 1/4" for proper fit.

**Note:** Panels up to 3/4" will require special routing area around handles. Dimensions may vary depending on depth of panel.

### Handle Side Clearance

- At least 2-5/8" (67mm) on the handle side for fingertip clearances.

### Top and Bottom Clearance

- At least 3/16" (4.75mm) at the top and bottom edges to allow for trim flange.

### Hinge Side Clearance

- A 3/4" (19mm) thick door panel may strike the adjacent countertops when the door is fully opened. Therefore, the hinge side clearance to raised panel will vary according to the installation situation.
  - Allow 1-3/4" (44mm) clearance when installation does not include side panels.
  - The installation of 3/4" (19mm) thick side panels requires less clearance because the space between the door and adjacent countertop is wider.
- To avoid door contact to countertop consider:
  - Miter the corner of the adjacent countertops 45°, or
  - Pull the refrigerator forward enough to avoid contact.

### Stability Leg

- The top-freezer refrigerator is the first cabinet-depth top-freezer. This means depth is more shallow than conventional models and the width is larger. The stability leg gives the unit extra support.

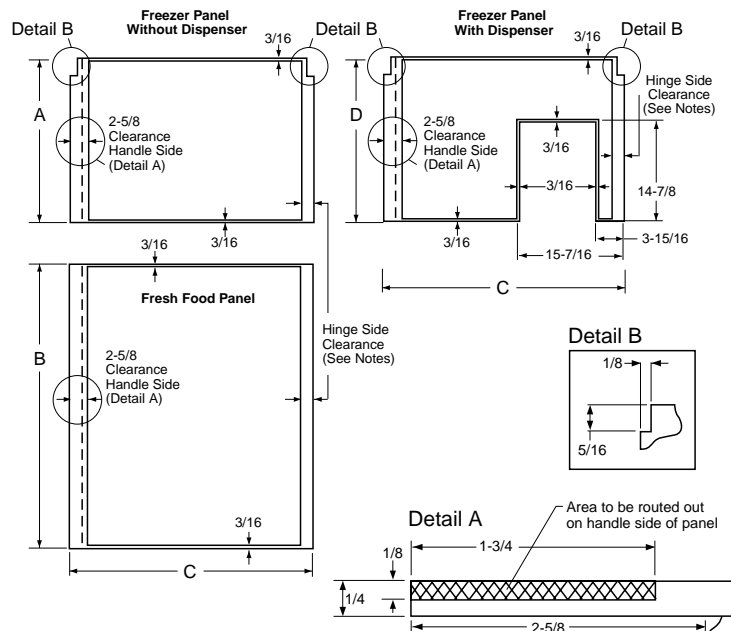

**IMPORTANT:** Before finalizing specifications for your GE Profile CustomStyle Refrigerator, please NOTE:

- A minimum of 36" is required for refrigerator installation
- Be sure to allow for 1/2" or 3/4" side panels in addition to the 36" minimum

# GE® Top-Freezer Refrigerators

	GE "K" Series								
	GTS22KBP GTS22KCP	GTS22KHP	GTH22SBP GTH22SHP	GTH18KBP GTS18KBP	GTL18KBP	GTS18KCP GTL18KCP	GTS18KHP	GTS18SBP GTS18SHP	GTS16KBM
<b>Capacity</b>									
Total (cu. ft.)	21.7	21.7	21.7	17.9	17.9	17.9	17.9	17.9	15.6
Fresh food (cu. ft.)	15.35	15.35	15.35	12.87	12.87	12.87	12.87	12.87	11.69
Freezer (cu. ft.)	6.35	6.35	6.35	4.98	4.98	4.98	4.98	4.98	3.86
Shelf area (sq. ft.)	25.3	24.9	25.3	22.4	22.0	22.4	22.4	22.4	19.6
<b>Fresh Food Features</b>									
Upfront temperature controls	Illuminated	Illuminated	Illuminated	Illuminated	Illuminated	Illuminated	Illuminated	Illuminated	●
Cabinet shelves	4 Glass	4 Glass	4 Glass	4 Glass	4 Glass	4 Glass	4 Glass	4 Glass	4 Glass
Adjustable	4 Split	4 Split	4 Split	4 Split	4 Split	4 Split	4 Split	4 Split	4 Split
Spillproof	4	4	4	4	4	4	4	4	4
Internal water dispenser	●	●	- / ●	●	●	●	●	- / ●	●
GE SmartWater™ filtration	●	●	- / ●	●	●	●	●	- / ●	●
Vegetable/fruit crisper(s)	2 Adj. Humid.	2 Adj. Humid.	2 Adj. Humid.	2 Adj. Humid.	2 Adj. Humid.	2 Adj. Humid.	2 Adj. Humid.	2 Adj. Humid.	2
Snack pan	●	●	●	●	●	●	●	●	●
Pivot-out pan removal system	●	●	●	●	●	●	●	●	●
Adjustable gallon door bins	3 (Adj.)	3 (Adj.)	3 (Adj.)	3 (Adj.)	3 (Adj.)	3 (Adj.)	3 (Adj.)	3 (Adj.)	
Fixed door bins	1 (Tall Bottle)	1 (Tall Bottle)	1 (Tall Bottle)	1 (Gallon)	1 (Gallon)	1 (Gallon)	1 (Gallon)	1 (Gallon)	2 F/W (1 w/ gallon storage) 2 w/ gallon storage
Door shelves									
Dairy compartment	●	●	●	●	●	●	●	●	●
Interior light system	Dual	Dual	Dual	Dual	Dual	Dual	Dual	Dual	Single
Quiet Design	Deluxe	Deluxe	Deluxe	Deluxe	Deluxe	Deluxe	Deluxe	Deluxe	Deluxe
Automatic moisture control	●	●	●	●	●	●	●	●	●
NeverClean™ condenser	●	●	●	●	●	●	●	●	●
ENERGY STAR®			●	● / -		●	●	●	●
<b>Freezer Features</b>									
Factory-installed icemaker	Opt. (IM4A) ●	●	Opt. (IM4A)●	Opt. (IM4A)	Opt. (IM4A)	Opt. (IM4A)	●	Opt. (IM4A)●	Opt. (IM4A)
Ice 'N Easy trays	2 / -		2	2		2	2	2	2
Ice storage bin	- / Ice Bucket	Ice Bucket			Ice Bucket				
FrostGuard™ technology			●						
Spillproof freezer floor	●	●	●	●	●	●	●	●	●
Wire freezer compartment shelves	1 F/W (2 pos.)	1 F/W (2 pos.)	1 F/W (2 pos.)	Step	Step	Step	Step	Step	Step
Adjustable door bins	1 (Adj.)	1 (Adj.)	1 (Adj.)	2	2	2	2	2	
Fixed door bins	1 Split	1 Split	1 Split						
Fixed door shelves									2
Interior light	●	●	●	●	●	●	●	●	●
<b>Exterior</b>									
Color(s) available*	WW, CC, BB	WW, CC, BB	BS	WW, CC, BB	CleanSteel™ Black	WW, CC, BB/ CleanSteel™ CM/Black	WW, CC, BB	BS	WW, CC
Door handle(s)*	CM	CM	CM	CM	Black	CM/Black	Black	Black	CM
Customer installed handles	●	●	●	●	●	●	●	●	●
Exterior design	Rounded Doors	Rounded Doors	Rounded Doors	Rounded Doors	Rounded Doors	Rounded Doors	Rounded Doors	Rounded Doors	Square Doors
Reversible doors	●	●	●	●	●	●	●	●	●
Adjustable rollers	Front	Front	Front	Front	Front	Front	Front	Front	Front
<b>Weights &amp; Dimensions</b>									
Height to top of hinge (in.) A	67-1/2	67-1/2	67-1/2	66-5/8	66-5/8	66-5/8	66-5/8	66-5/8	64-3/4
Height to top of case (in.) B	66-7/8	66-7/8	66-7/8	66-1/8	66-1/8	66-1/8	66-1/8	66-1/8	64-1/4
Height to mid-freezer (in.)	54-1/2	54-1/2	54-1/2	53-15/16	53-15/16	53-15/16	53-15/16	53-15/16	54-3/8
Case depth without door (in.) C	27-5/8	27-5/8	27-5/8	27-1/2	27-1/2	27-1/2	27-1/2	27-1/2	25-7/8
Case depth less door handle (in.) D	31-5/8	31-5/8	31-5/8	30-1/4	30-1/4	30-1/4	30-1/4	30-1/4	29-1/8
Case depth with door handle (in.) E	33-5/8	33-5/8	33-5/8	32-1/8	32-1/8	32-1/8	32-1/8	32-1/8	31
Depth w/fresh food door open 90° (in.) F	63	63	63	58-1/8	58-1/8	58-1/8	58-1/8	58-1/8	54-7/8
Width (in.) G	32-7/8	32-7/8	32-7/8	29-1/2	29-1/2	29-1/2	29-1/2	29-1/2	28
Width w/door open 90° less door handle (in.) H	33	33	33	30	30	30	30	30	28-5/8
Air clearances Each side (in.)	1/8	1/8	1/8	1/8	1/8	1/8	1/8	1/8	3/4
Top (in.)	1	1	1	1	1	1	1	1	1
Back (in.)	1	1	1	1	1	1	1	1	1
Approx. shipping weight (lbs.)	255	260	255	231	236	231	231	231	185
Power/Ratings	120V, 60Hz, 15Amps								

\*Color(s) available: BS = Black case with Stainless steel doors, WW = White on white, CC = Bisque on bisque, BB = Black on black, CM = Color-Matched.

**ALL MODELS AVAILABLE IN U.S. AND CANADA.**

## Top-Freezer No-Frost Refrigerators

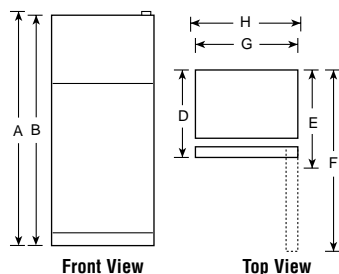

**Note: All Top-Freezer No-Frost Right-Hand Refrigerator Doors:** As you face the front of the refrigerator, the handle is on your left and the hinges are on your right.  
**All Top-Freezer No-Frost Left-Hand Refrigerator Doors:** As you face the front of the refrigerator, the handle is on your right and the hinges are on your left.



Total volume and shelf area are calculated by the Association of Home Appliance Manufacturers' standards.



Listed by Underwriters Laboratories

# GE® Top-Freezer Refrigerators

	GE "J" Series			GE "I" Series	GE "H" Series	GE "F" Series	GE "E" Series	
	GTS22JBP GTS22JCP	GTH18JBP GTS18JBP	GTS18JCP	GTS20IBN GTS20ICN	GTS18HBM GTS18HCM	GTS22FBP	GTS18FBM	GTS18EBM
<b>Capacity</b>								
Total (cu. ft.)	21.8	17.9	17.9	20.0	17.6	21.8	17.6	17.6
Fresh food (cu. ft.)	15.47	12.89	12.89	14.61	13.62	15.47	13.62	13.62
Freezer (cu. ft.)	6.37	5.03	5.03	5.41	4.01	6.37	4.01	4.01
Shelf area (sq. ft.)	25.4/25.1	22.6	22.2	24.5	20.3	25.4	20.3	20.3
<b>Fresh Food Features</b>								
Upfront temperature controls	Illuminated	Illuminated	Illuminated	●	●	Illuminated	●	●
Cabinet shelves	3 Glass	3 Glass	3 Glass	3 Glass	3 Glass	3 (1 F/W wire, 1 split wire, 1 split glass)	3 (1 F/W wire, 1 split wire, 1 split glass)	3 (1 F/W wire, 1 split wire, 1 split glass)
Adjustable	2 Split, 1 F/W	2 Split, 1 F/W	2 Split, 1 F/W	2 Split, 1 F/W	2 Split, 1 F/W	3	3	3
Spillproof	●	●	●	SpillKeeper™				
Vegetable/fruit crisper(s)	2	2	2	2	2	2	2	2
Snack pan	●	●	●	●	●	●	●	●
Pivot-out pan removal system	●	●	●			●		
Fixed door bins	1 F/W w/ gallon storage			2 F/W (1 w/ gallon storage)				
Door shelves	1 w/ gallon storage	1 w/ gallon storage	1 w/ gallon storage	2 Adj. F/W w/ gallon storage	2 w/ gallon storage	3 (2 w/ gallon storage)	2 w/ gallon storage	2 (Tall Bottle)
Dairy compartment	●	●	●	●	●	●	●	●
Interior light system	Dual	Dual	Dual	Single	Single	Dual	Single	Single
Quiet Design	Deluxe	Deluxe	Deluxe	Deluxe	Deluxe	Deluxe	Deluxe	Deluxe
Automatic moisture control	●	●	●	●	●	●	●	●
NeverClean™ condenser	●	●	●	●	●	●	●	●
ENERGY STAR®		● / -						
<b>Freezer Features</b>								
Factory-installed icemaker	Opt. (IM4A) / ●	Opt. (IM4A)	●	Opt. (IM4A) / ●	Opt. (IM4A) / ●	Opt. (IM4A)	Opt. (IM4A)	Opt. (IM4A)
Ice 'N Easy trays	2 / -	2		1 / -	2 / -	2	2	2
Ice storage bin	- / Ice Bucket		Ice Bucket		- / Ice Bucket			
Spillproof freezer floor	●	●	●			●		
Wire freezer compartment shelves	1 F/W (2 pos.)	Step	Step	2 Adj. F/W	Step / -	1 F/W (2 pos.)	Step	Step
Fixed door shelves	2 F/W w/ gallon storage	2 Full-width	2 Full-width	2 Fixed	2	2 w/gal. storage	2	2
<b>Exterior</b>								
Color(s) available*	WW, CC	WW, CC	WW, CC	WW, CC	WW, CC	WW, CC	WW, CC	WW, CC
Door handle(s)*	CM	CM	CM	CM	CM	CM	CM	CM
Customer installed handles	●	●	●	●	●			
Exterior design	Rounded Doors	Rounded Doors	Rounded Doors	Rounded Doors	Square Doors	Rounded Doors	Square Doors	Square Doors
Reversible doors	●	●	●	●	●	●	●	●
Adjustable rollers	Front	Front	Front	Front	Front	Front	Front	Front
<b>Weights &amp; Dimensions</b>								
Height to top of hinge (in.) A	67-1/2	66-5/8	66-5/8	68-1/8	67-3/8	67-1/2	67-3/8	67-3/8
Height to top of case (in.) B	66-7/8	66-1/8	66-1/8	67-1/2	66-7/8	66-7/8	66-7/8	66-7/8
Height to mid-freezer (in.)	54-1/2	53-15/16	53-15/16	56-3/4	57	54-1/2	57	57
Case depth without door (in.) C	27-5/8	27-1/2	27-1/2	27-1/2	26-3/4	27-5/8	26-3/4	26-3/4
Case depth less door handle (in.) D	31-5/8	30-1/4	30-1/4	30-5/8	30-1/2	31-5/8	30-1/2	30-1/2
Case depth with door handle (in.) E	33-5/8	32-1/8	32-1/8	32-3/8	32-3/8	33-5/8	32-3/8	32-3/8
Depth w/fresh food door open 90° (in.) F	63	58-1/8	58-1/8	57-15/16	56-3/8	63	56-3/8	56-3/8
Width (in.) G	32-7/8	29-1/2	29-1/2	29-1/2	28	32-7/8	28	28
Width w/door open 90° less door handle (in.) H	33	30	30	30-3/4	28-7/8	33	28-7/8	28-7/8
Air clearances Each side (in.)	1/8	1/8	1/8	1/8	3/4	1/8	3/4	3/4
Top (in.)	1	1	1	1	1	1	1	1
Back (in.)	1	1	1	1	1	1	1	1
Approx. shipping weight (lbs.)	255/260	226	231	227	192	255	187	187
Power/Ratings	120V, 60Hz, 15Amps							

\* Color(s) available: WW = White on white, CC = Bisque on bisque, CM = Color-Matched.

**ALL MODELS AVAILABLE IN U.S. AND CANADA.**

## Top-Freezer No-Frost Refrigerators

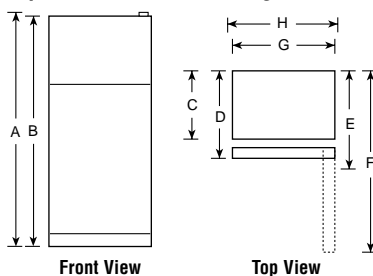

Total volume and shelf area are calculated by the Association of Home Appliance Manufacturers' standards.



Listed by Underwriters Laboratories

**Note:** All Top-Freezer No-Frost Right-Hand Refrigerator Doors: As you face the front of the refrigerator, the handle is on your left and the hinges are on your right.  
All Top-Freezer No-Frost Left-Hand Refrigerator Doors: As you face the front of the refrigerator, the handle is on your right and the hinges are on your left.

# GE Top-Freezer Refrigerators

	GE "B" Series							GE "A" Series	
	GTR18BBM	GTS17BBM GTS17BCM	GTR17BBM	GTS15BBM GTH15BBM	GTS15BCM	GTR15BBM	GTS12BBP	GTS18ABM	GTR11AAP
<b>Capacity</b>									
Total (cu. ft.)	17.6	16.9	16.9	14.6	14.6	14.6	11.7	17.6	10.3
Fresh food (cu. ft.)	13.62	13.05	13.05	10.77	10.77	10.77	8.80	13.58	7.95
Freezer (cu. ft.)	4.01	3.86	3.86	3.86	3.86	3.86	2.90	4.01	2.37
Shelf area (sq. ft.)	18.0	17.5/16.7	17.5	17.2	16.4	17.2	13.6	16.9	14.0
<b>Fresh Food Features</b>									
Upfront temperature controls	●	●	●	●	●	●	●	●	●
Cabinet shelves	2 Wire	2 Wire	2 Wire	2 Wire	2 Wire	2 Wire	2 Wire	2 Wire	2 Wire
Adjustable	2 F/W	2 F/W	2 F/W	2 F/W	2 F/W	2 F/W	2 F/W	2 F/W	2 F/W
Vegetable/fruit crisper(s)	2	2	2	2	2	2	Divided	1 F/W	1 F/W
Door shelves	2 (Tall Bottle)	2 (Tall Bottle)	2 (Tall Bottle)	2 (Tall Bottle)	2 (Tall Bottle)	2 (Tall Bottle)	(1 Tall Bottle)	2 (Tall Bottle)	4 (1 Tall Bottle)
Dairy compartment	●	●	●	●	●	●	●	●	●
Interior light system	Single	Single	Single	Single	Single	Single	Single	Single	Single
Quiet Design	Deluxe	Deluxe	Deluxe	Deluxe	Deluxe	Deluxe	Deluxe	Deluxe	Deluxe
Automatic moisture control	●	●	●	●	●	●	●	●	●
NeverClean™ condenser	●	●	●	●	●	●	●	●	●
ENERGY STAR®				- / ●					●
<b>Freezer Features</b>									
Factory-installed icemaker & bin	Opt. (IM4A)	Opt. (IM4A) / ●	Opt. (IM4A)	Opt. (IM4A)	●	Opt. (IM4A)	Opt. (IM4A)	Opt. (IM4A)	
Ice 'N Easy trays	2	2 / -	2	2		2	1	1	2
Ice storage bin	- / Ice Bucket			Ice Bucket					
Wire freezer compartment shelves									1 F/W
Fixed door shelves	2	2	2	2	2	2	2	2	2
<b>Exterior</b>									
Color(s) available*	WW, CC	WW, CC WW, CC	WW, CC	WW, CC WW, CC	WW, CC	WW, CC	WW, CC	WW	WW
Door handle(s)*	CM Recessed	CM	CM Recessed	CM	CM	CM Recessed	CM	CM	CM Recessed
Exterior design	Square Doors	Square Doors	Square Doors	Square Doors	Square Doors	Square Doors	Rounded Doors	Square Doors	Rounded Doors
Reversible doors	●	●	●	●	●	●	●	●	●
Choose right or left door opening	●	●	●	●	●	●	●	●	●
Adjustable rollers	Front	Front	Front	Front	Front	Front	Front	Front	Front
<b>Weights &amp; Dimensions</b>									
Height to top of hinge (in.) A	67-3/8	67-3/8	67-3/8	61-3/4	61-3/4	61-3/4	60-5/8	67-3/8	58-3/4
Height to top of case (in.) B	66-7/8	66-7/8	66-7/8	61-1/4	61-1/4	61-1/4	60-1/4	66-7/8	58-1/4
Height to mid-freezer (in.)	57	57	57	51-3/8	51-3/8	51-3/8	51-3/4	57	50
Case depth without door (in.) C	26-3/4	26-3/4	26-3/4	25-7/8	25-7/8	25-7/8	27-1/2	26-3/4	25
Case depth less door handle (in.) D	30-1/2	30	30	29-1/8	29-1/8	29-1/8	30-1/4	30-1/2	27
Case depth with door handle (in.) E	30-1/2	31-7/8	30	31	31	29-1/8	32	32-3/8	27
Depth w/fresh food door open 90° (in.) F	56-3/8	55-3/4	55-3/4	54-7/8	54-7/8	54-7/8	51-5/8	56-3/8	48-3/4
Width (in.) G	28	28	28	28	28	28	23-3/8	28	23-5/8
Width w/door open 90° less door handle (in.) H	28-7/8	28-5/8	28-5/8	28-5/8	28-5/8	28-5/8	24-1/8	28-7/8	24-1/8
Air clearances Each side (in.)	3/4	3/4	3/4	3/4	3/4	3/4	3/4	3/4	1
Top (in.)	1	1	1	1	1	1	2	1	3
Back (in.)	1	1	1	1	1	1	3/4	1	1
Approx. shipping weight (lbs.)	178	179 / 184	178	166	171	165	155	177	158
Power/Ratings	120V, 60Hz, 15Amps								

\*Color(s) available: WW = White on white, CC = Bisque on bisque, CM = Color-Matched.

**ALL MODELS AVAILABLE IN U.S. AND CANADA.**

## Top-Freezer No-Frost Refrigerators

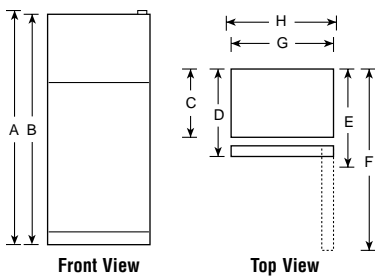

Total volume and shelf area are calculated by the Association of Home Appliance Manufacturers' standards.



Listed by Underwriters Laboratories

**Note:** All Top-Freezer No-Frost Right-Hand Refrigerator Doors: As you face the front of the refrigerator, the handle is on your left and the hinges are on your right.  
 All Top-Freezer No-Frost Left-Hand Refrigerator Doors: As you face the front of the refrigerator, the handle is on your right and the hinges are on your left.

# GE Cycle and Manual Defrost Refrigerators

	GE	
	Cycle Defrost	Manual Defrost
	GFR12AAM	GMS10AAM
<b>Capacity</b>		
Total (cu. ft.)	11.7	9.7
Fresh food (cu. ft.)	9.04	8.74
Freezer (cu. ft.)	2.61	.97*
Shelf area (sq. ft.)	13.9	9.88
<b>Features</b>		
Ice 'N Easy trays	2	2
Freezer chiller tray with baffle		●
Cabinet shelves	2 Adj.	2 Adj.
Vegetable/fruit crisper	2	1 F/W
Door shelves	3	5 (2 Egg w/Pockets)
Tall bottle storage on door	●	●
Dairy compartment(s)	1 Full Door Width	1
Freezer compartment shelf(s)	1 F/W	1 F/W
<b>Economical/Quiet</b>		
Cabinet/door insulation	Foam	Foam
Cabinet/door liner	Plastic	Plastic
<b>Appearance</b>		
Color(s) available	White	White
Door handle(s)	White Recessed	Black
Reversible doors	●	
Right or left door opening		●
<b>Weights &amp; Dimensions</b>		
Height to top of hinge (in.) A	59-1/2	58
Height to top of case (in.) B	59-5/16	57-9/16
Case depth without door (in.) C	26	21-3/8
Case depth with door less handle (in.) D	28	23-1/2
Case depth with door handle (in.) E	28	24-13/16
Depth with door open 90° less door handle (in.) F	50-1/8	44-13/16
Width (in.) G	23-1/2	23
Width w/door open 90° less door handle (in.) H	23-1/2	23-1/2
Air clearances Each side (in.)	1/4	5/8
Top (in.)	1	2
Back (in.)	2	1
Approx. shipping weight (lbs.)	139	135

\*Compartment for short-term storage of frozen food. The frozen food compartment of this refrigerator will make ice, and pre-frozen foods can be stored for about **two weeks**. It will not effectively freeze fresh foods or provide long-term storage for meats, poultry, or fish.

## Cycle Defrost Two-Door Refrigerator

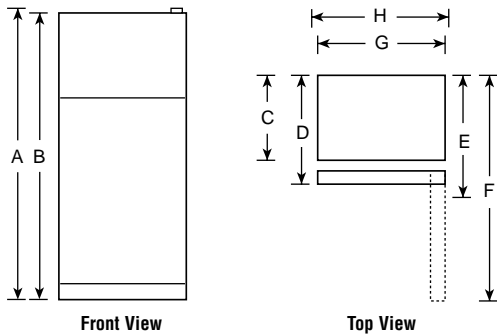

## Manual Defrost Single-Door Refrigerator

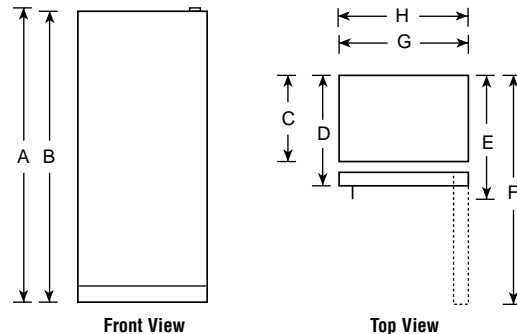

## GE Profile™ and GE® Wine Coolers

	GE Profile	GE
	PWR04FANBB PWR04FANBS	GWR03AAM
<b>Capacity</b>		
Total (cu. ft.)	4.5	2.4
Bottle capacity	29	24 Maximum
<b>Features</b>		
Electronic touch controls	●	
Adjustable temperature control (45-65°F)	●	Knob
See-through door		●
Door design	Contoured	Flat
Pull-out and adjustable racks	Chrome w/bowed handles	4
Multiple shelf liner positions	5 full-width, 1 display	
Interior light	●	
Interior light timer (60 min. delay)	●	
Lock	●	
External condenser		●
<b>Appearance</b>		
Color(s) available	Black case and trim Black case and Stainless trim	Black case and trim
Door handle	Recessed	
Free-standing	●	●
Meets California Energy Commission (CEC) requirements	●	●
Cabinet liner color	Black	White
Reversible door	●	
<b>Weights &amp; Dimensions</b>		
<b>Height (in.) A</b>	34 maximum	25-1/4
<b>Width (in.) B</b>	23 maximum	18-5/8
<b>Depth with handle (in.) C</b>	22 maximum	19-3/8
<b>Depth with door open 90° (in.) D</b>	TBD	37-1/4
Each side (in.)	1 maximum	
Air clearances Back (in.)	2 maximum	5
Approx. shipping weight (lbs.)	TBD	51

### Wine Coolers

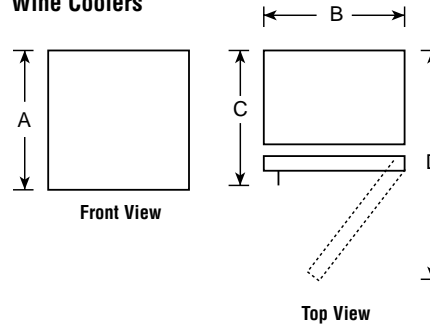

## GE Spacemaker™ Compact Refrigerators

	GE		
	GMR06AAM	GMR04BAN	GMR02BAN
<b>Capacity</b>			
Total (cu. ft.)	6.0	4.3	1.7
Fresh food (cu. ft.)	5.51	3.89	1.51
Freezer (cu. ft.)	.49**	.42**	.21**
Shelf area (sq. ft.)	8.8	6.0	2.9
<b>Features</b>			
Ice 'N Easy trays	2 Mini	1 Mini	1 Mini
Manual defrost	●	●	●
Cabinet shelves (wire)	2 Adj.	2-1/2 Adj.	1
Can rack		●	
Door shelves	3 F/W	1 F/W, 2 half-width	1 F/W, 1 half-width
Interior light	●		
<b>Economical/Quiet</b>			
Cabinet/door insulation	Foam	Foam	Foam
Cabinet/door liner	HIPS	ABS	ABS
<b>Appearance</b>			
Color(s) available*	WW	WW, BB	WW, BB
Door handles	White Visor	Color-Matched Recessed	Color-Matched Recessed
Rounded doors		●	●
Reversible doors	●		
<b>Weights &amp; Dimensions</b>			
<b>Height (in.) A</b>	34 -1/4	33-1/4	18-15/16
<b>Width (in.) B</b>	23-5/8	20-11/16	17-1/2
<b>Depth with handle (in.) C</b>	25-7/8	21-3/4	19-1/4
<b>Depth with door open 90° (in.) D</b>	47 -1/2	40-1/4	35-1/2
Air clearances Each side (in.)	0†	1/2	1/2
Top (in.)	1-1/2	2	2
Back (in.)	3/4	2	2
Approx. shipping weight (lbs.)	88	79	51
<b>Accessories</b>			
Custom trim and black panel	TK6 Optional		

### Spacemaker Compact Refrigerators

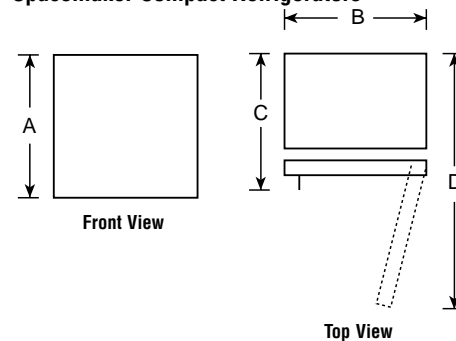

\*Color(s) available: WW = White on white, BB = Black on black.

\*\*Compartment for short-term storage of frozen food. The frozen food compartment of this refrigerator will make ice, and pre-frozen foods can be stored for about **two weeks**. It will not effectively freeze fresh foods or provide long-term storage for meats, poultry, or fish.

† If installed against a wall, allow 1 -1/4" on hinge side to allow for proper door opening.

# GE Profile™ and GE® Bottom-Freezer Refrigerators

	GE Profile				GE		
	PDS22SBP PDS22SCP	PDS22MBP PDS22MCP	PDS20SBP PDS20SCP	PDS20MBP PDS20MCP	GBS22KBP	GBS22HBP	GBS20KBP
Stainless steel model	●		●				
<b>Capacity</b>							
Total (cu. ft.)	22.2	22.2	19.5	19.5	22.3	22.3	19.5
Fresh food (cu. ft.)	15.21	15.21	13.21	13.21	15.21	15.22	13.21
Freezer (cu. ft.)	7.04	7.04	6.31	6.31	7.05	7.09	6.32
Shelf area (sq. ft.)	27.66	27.66	24.44	24.44	23.99	24.27	21.43
<b>Fresh Food Features</b>							
Cabinet shelves	4 Glass	4 Glass	4 Glass	4 Glass	4 Glass	3 Glass	4 Glass
Adjustable	4 Split	4 Split	4 Split	4 Split	4 Split	2 Split, 1 F/W	4 Split
Slide-out	2	2	2	2			
Spillproof	4	4	4	4	4		4
QuickSpace shelf	●	●	●	●			
ShelfSaver™ rack	●	●	●	●			
Vegetable/fruit crisper(s)	2 Adj. Humid.	2 Adj. Humid.	2 Adj. Humid.	2 Adj. Humid.	2 Adj. Humid.	2 Clear	2 Adj. Humid.
Snack pan	Clear	Clear	Clear	Clear	Clear	Clear	Clear
ClearLook™ adjustable bins	4	4		4	4 opaque		4 opaque
Snugger™ clip			●	●			
Fixed door bins	1 F/W w/gal. storage	1 F/W w/gal. storage	1 F/W w/gal. storage	1 F/W w/gal. storage	1 F/W w/gal. storage	2 F/W (1 w/gal. storage)	1 F/W w/gal. storage
Dairy compartment	●	●	●	●	●	●	●
Interior light	Dual	Dual	Dual	Dual	Dual	●	Dual
Quiet Design	Deluxe	Deluxe	Deluxe	Deluxe	Deluxe	Deluxe	Deluxe
Automatic moisture control	●	●	●	●	●	●	●
NeverClean™ condenser	●	●	●	●	●	●	●
ENERGY STAR®	●	●	●	●	●	●	●
<b>Freezer Features</b>							
Factory-installed electronic icemaker & bin	Opt. (IM4A)	Opt. (IM4A)	Opt. (IM4A)	Opt. (IM4A)	IM4A	Opt. (IM4A)	IM4A
GE SmartWater™ filtration	- / ●	- / ●	- / ●	- / ●			
Ice 'N Easy trays	2	2	2	2	2	2	2
Ice tray shelf	●	●	●	●	●	●	●
Ice storage bin	●	●	●	●	●	●	●
Full slide-out wire basket(s)	2 FW/1 Split	2 FW/1 Split	1 FW, 2 Split	1 FW, 2 Split	1 FW	1 FW	1 FW
Wire compartment shelves					1 F/W	2 Split	1 F/W
Door shelves					1 F/W		1 F/W
Interior light	●	●	●	●	●	●	●
<b>Exterior</b>							
Color(s) available*	SS	WW, CC, BB	BS	WW, CC, BB	WW, CC	WW, CC, BB	WW, CC
Door handle(s)	Stainless	Color-Matched	Color-Matched	Color-Matched	Color-Matched	Color-Matched	Color-Matched
Exterior design	Contoured Doors	Contoured Doors	Rounded Doors	Rounded Doors	Rounded Doors	Contoured Doors	Rounded Doors
Door stops	●	●	●	●	●	●	●
Reversible doors	●	●	●	●	●	●	●
Choose left or right door opening			●				
Adjustable rollers	Front	Front	Front	Front	Front	Front	Front
<b>Weights &amp; Dimensions</b>							
Height to top of hinge (in.) A	68-5/8	68-5/8	68	68	68-5/8	68-5/8	68
Height to top of case (in.) B	67-7/8	67-7/8	67-1/4	67-1/4	67-7/8	67-7/8	67-1/4
Case depth without door (in.) C	28-1/4	28-1/4	28-1/4	28-1/4	28-1/4	28-1/4	28-1/4
Depth less door handle (in.) D	31-3/4	31-3/4	31-3/4	31-3/4	31-3/4	31-3/4	31-3/4
Depth with door handle (in.) E	33-7/8	33-7/8	33-7/8	33-7/8	34-1/8	34-1/8	34-1/8
Depth w/door open 90° (in.) F	62	62	59	59	62	62	59
Width (in.) G	32-7/8	32-7/8	29-7/8	29-7/8	32-7/8	32-7/8	29-7/8
Side clearance for 90° door open	1-1/4	1-1/4	2-3/8	2-3/8	1-1/4	1-1/4	2-3/8
Air clearances Each side (in.)	1/8	1/8	1/8	1/8	1/8	1/8	1/8
Top (in.)	1	1	1	1	1	1	1
Back (in.)	1	1	1	1	1	1	1
Approx. shipping weight (lbs.)	287	287	265	265	287	287	265
Power/Ratings	120V, 60Hz, 15Amps						

\*Color(s) available: SS = Stainless steel, BS = Black case with stainless steel doors, WW = White on white, CC = Bisque on bisque, BB = Black on black.

ALL MODELS AVAILABLE IN U.S. AND CANADA.

## Bottom-Freezer Refrigerators

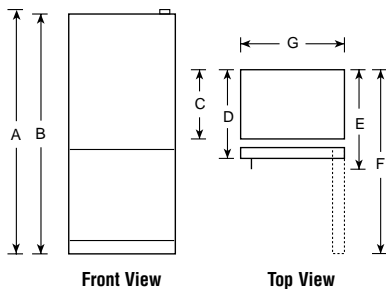

Total volume and shelf area are calculated by the Association of Home Appliance Manufacturers' standards.



Listed by Underwriters Laboratories

# GE Bottom-Freezer Refrigerators

	GE			
	GDS18SBP	GDS18LBP	GBS18KBP	GBS18HBP
Stainless steel model	●			
<b>Capacity</b>				
Total (cu. ft.)	18.1	18.1	18.1	18.1
Fresh food (cu. ft.)	13.44	13.44	13.44	13.44
Freezer (cu. ft.)	4.64	4.64	4.64	4.64
Shelf area (sq. ft.)	21.0	21.0	22.2	22.2
<b>Fresh Food Features</b>				
Brita® Filtered Water Door Module	●	●		
Cabinet shelves	4 Glass	4 Glass	4 Glass	3 Glass
Adjustable	4 Split	4 Split	4 Split	2 Split, 1 F/W
Slide-out	2	2		
Spillproof	4	4	4	
ShelfSaver™ rack	●	●		
Vegetable/fruit crisper(s)	2 Adj. Humid.	2 Adj. Humid.	2 Adj. Humid.	2 Clear
Snack pan	Clear	Clear	Clear	Clear
Adjustable gallon door bins	3	3	4	
Snugger™ clip	●	●		
Fixed door bins	1 F/W w/gal. storage	1 F/W w/gal. storage	1 F/W w/gal. storage	2 F/W (1 w/gal. storage)
Dairy compartment	●	●	●	●
Interior light	Dual	Dual	Dual	●
Quiet Design	Deluxe	Deluxe	Deluxe	Deluxe
Automatic moisture control	●	●	●	●
NeverClean™ condenser	●	●	●	●
ENERGY STAR®	●	●	●	●
<b>Freezer Features</b>				
Factory-installed electronic icemaker & bin	Opt. (IM4A)	Opt. (IM4A)	Opt. (IM4A)	Opt. (IM4A)
Ice 'N Easy trays	2	2	2	2
Ice storage bin	●	●	●	●
Full slide-out wire basket(s)	1 F/W, 2 Split	1 F/W, 2 Split	1 F/W	1 F/W
Wire compartment shelves			1 F/W	1 F/W
Interior light	●	●	●	●
<b>Exterior</b>				
Color(s) available*	SS	WW, CC, BB	WW, CC	WW, CC, BB
Door handle(s)	Color-Matched	Color-Matched	Color-Matched	Color-Matched
Customer-installed handles		●		
Exterior design	Rounded Doors	Rounded Doors	Rounded Doors	Rounded Doors
Door stops	●	●	●	●
Reversible doors		●	●	●
Choose left or right door opening	●			
Adjustable rollers	Front	Front	Front	Front
<b>Weights &amp; Dimensions</b>				
Height to top of hinge (in.) A	66-1/4	66-1/4	66-1/4	66-1/4
Height to top of case (in.) B	65-3/4	65-3/4	65-3/4	65-3/4
Case depth without door (in.) C	25-1/4	25-1/4	25-1/4	25-1/4
Depth less door handle (in.) D	28	28	28	28
Depth with door handle (in.) E	30-3/8	30-3/8	30-3/8	30-3/8
Depth w/door open 90° (in.) F	57-3/4	57-3/4	57-3/4	57-3/4
Width (in.) G	31	31	31	31
Side clearance for 90° door open	2-3/8	2-3/8	2-3/8	1-3/8
Air clearances Each side (in.)	0	0	0	0
Top (in.)	1	1	1	1
Back (in.)	1/2	1/2	1/2	1/2
Approx. shipping weight (lbs.)	257	257	257	262
Power/Ratings	120V, 60Hz, 15Amps			

\*Color(s) available: SS = Black case with stainless steel doors, WW = White on white, CC = Bisque on bisque, BB = Black on black.  
**ALL MODELS AVAILABLE IN U.S. AND CANADA.**

## Bottom-Freezer Refrigerators

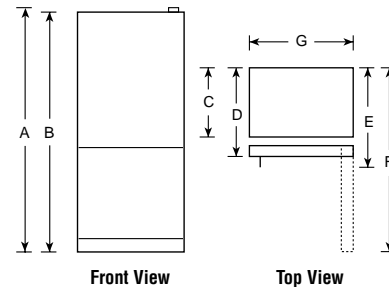

 Total volume and shelf area are calculated by the Association of Home Appliance Manufacturers' standards.



Listed by Underwriters Laboratories

# GE Chest Freezers

	GE							
	FCM25RM	FCM20DM	FCM15DM	FCM15SM	FCM9DM	FCM7DN	FCM5DM	FCM5SM
<b>Capacity</b>								
Total volume (cu. ft.)	25.1	19.7	14.8	14.8	8.8	7.0	5.0	5.0
<b>Features</b>								
Manual defrost	●	●	●	●	●	●	●	●
Temperature control	Adj.	Adj.	Adj.	Adj.	Adj.	Adj.	Adj.	Adj.
Power "ON" light						●	●	
Wraparound condenser	●	●	●	●	●	●	●	●
Wraparound evaporator	●	●	●	●	●	●	●	●
Limited food loss warranty*	●	●	●	●	●	●	●	●
Upfront defrost water drain	●	●	●	●	●	●	●	●
Interior light	●	●	●	●	●	●	●	●
Lock	●	●	●	●	●	●	●	●
Lift-out and sliding bulk storage basket(s)	4	3	2	1	2	2	2	1
<b>Economical/Quiet</b>								
Insulation (cabinet and lid)—Foam	●	●	●	●	●	●	●	●
Cabinet liner	Steel Epoxy-Coated	Steel Epoxy-Coated	Steel Epoxy-Coated	Steel Epoxy-Coated	Steel Epoxy-Coated	Textured Aluminum	Textured Aluminum	Textured Aluminum
<b>Appearance</b>								
Color available	White	White	White	White	White	White	White	White
Handle	●	●	●	Recessed	●	Recessed	Recessed	Recessed
Textured steel case and lid	●	●	●	●	●	●	●	●
<b>Weights &amp; Dimensions</b>								
Height (in.) A	35	35	35	35	34-1/4	33-1/8	33	33
Width (in.) B	73-7/8	61-1/4	48	48	41	38	29-1/8	29-1/8
Depth (in.) C	28-3/4	29-1/2	29-1/2	29-1/2	23-1/4	22-3/8	22-3/16	22-3/16
Height with lid open (in.) D	59-3/4	60-3/4	60-3/4	60-3/4	54-1/4	53-1/4	53-3/16	53-3/16
Air clearances	Each side (in.)	3	3	3	3	3	3	3
	Back (in.)	3	3	3	3	3	3	3
Approx. shipping weight (lbs.)	245	195	161	161	127	126	101	101

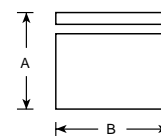

Front View

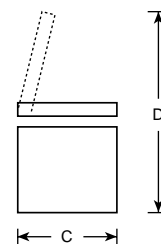

Side View

\*See written warranty for complete details.

# GE Upright Freezers

	GE							
	Frost-Free			Manual Defrost				
	FUF20DM	FUF17DM	FUF14DM	FUM21DM	FUM17DM	FUM14DM	FUM14SM	FUM5SM
<b>Capacity</b>								
Total volume (cu. ft.)	20.3	16.7	13.7	20.6	17.1	14.1	14.1	5.0
Shelf area (sq. ft.)	23.9	18.4	14.3	25.3	19.1	17.9	15.0	6.0
<b>Features</b>								
Temperature control	Adj.	Adj.	Adj.	Adj.	Adj.	Adj.	Adj.	Adj.
Limited food loss warranty*	●	●	●	●	●	●	●	●
Door shelves (total)	6	5	5	6	5	5	5	3
Defrost water drain				●	●	●	●	
Interior light	●	●	●	●	●	●	●	
Lock	●	●	●	●	●	●	●	
Cabinet shelves (total)	5 (3 Adj.)	4 (3 Adj.)	3 (2 Adj.)	5 (1 Adj.)	4 (1 Adj.)	4 (1 Adj.)	3	2
Slide-out bulk storage basket	1	1	1	1	1	1		
<b>Economical/Quiet</b>								
Defrost	Frost-Free	Frost-Free	Frost-Free	Manual	Manual	Manual	Manual	Manual
Magnetic door gasket	●	●	●	●	●	●	●	●
Cabinet liner	Baked enamel-on-steel	Baked enamel-on-steel	Baked enamel-on-steel	Baked enamel-on-steel	Baked enamel-on-steel	Baked enamel-on-steel	Baked enamel-on-steel	Polystyrene
Wraparound condenser	●	●	●	●	●	●	●	●
<b>Appearance</b>								
Color available	White	White	White	White	White	White	White	White
Door handle	●	●	●	●	●	●	Recessed	Recessed
Textured steel case/door	●	●	●	●	●	●	●	●
<b>Weights &amp; Dimensions</b>								
Height (in.) A	70	64-1/2	59	70	64-1/2	59	59	33-1/2
Width (in.) B	32	32	28	32	32	28	28	21-3/8
Depth (in.) C	28-1/2	26-1/2	28-1/2	28-1/2	26-1/2	28-1/2	28-1/2	26-1/8
Depth with door open 90° (in.) D	59-1/8	57-1/8	55-1/8	59-1/8	57-1/8	55-1/8	55-1/8	45-3/4
Air clearances	Each side (in.)	3	3	3	3	3	3	1
	Top (in.)	3	3	3	3	3	3	4
	Back (in.)	3	3	3	3	3	3	4
Approx. shipping weight (lbs.)	235	213	186	224	200	177	177	80

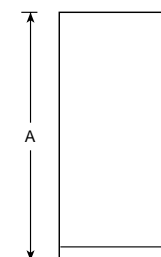

Front View

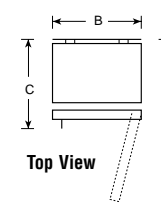

Top View

\*See written warranty for complete details.

## Create a Custom Look for Your GE Refrigerator

Decide from a choice of GE optional Panels and Trim to create a distinctive appearance for your new refrigerator. Precut panels in Stainless steel, Black, White or Bisque provide an exciting way to express your individual taste and preference, while complementing your kitchen.

### GE Profile CustomStyle™ Side-By-Side Refrigerators

Acrylic and Stainless Steel Panels

Model No.	Black Acrylic Panels	White Acrylic Panels	Bisque Acrylic Panels	Stainless Steel Panels
PSI23NCN	PSPK23CBB	PSPK23CWW	PSPK23CCC	–
PSI23MGN	PSPK23DBB	PSPK23DWW	PSPK23DCC	PSPK23DSS
PSI23NGN	PSPK23DBB	PSPK23DWW	PSPK23DCC	PSPK23DSS

Collar Trim

Model No.	Black Collar Trim	White Collar Trim	Bisque Collar Trim	Stainless Steel Collar Trim
PSI23NCN	TRMBISBB	TRMBISWW	TRMBISCC	TRMBISSS
PSI23SCN	TRMBISBB	TRMBISWW	TRMBISCC	TRMBISSS
PSI23MGN	TRMBISBB	TRMBISWW	TRMBISCC	TRMBISSS
PSI23NGN	TRMBISBB	TRMBISWW	TRMBISCC	TRMBISSS
PSI23SGN	TRMBISBB	TRMBISWW	TRMBISCC	TRMBISSS

### GE Profile CustomStyle Top-Freezer No-Frost Refrigerators

Acrylic Panels and Trim

Model No.	Black Acrylic Panels	White Acrylic Panels	Stainless Steel Panels	Black Collar Trim	White Collar Trim	Stainless Steel Collar Trim
PTI22MBM	PTPK22CBB	PTPK22CWW	PTPK22CSS	TRMBISBB	TRMBISWW	TRMBISSS
PTI22MFM	PTPK22DBB	PTPK22DWW	PTPK22DSS	TRMBISBB	TRMBISWW	TRMBISSS

### GE Spacemaker™ Compact Refrigerator

**TK6 Trim**

- Panel is black painted aluminum
- Trim is black plastic that covers entire side of door
- 1/4" wood can also be used with the trim

Order your own custom door panel to match cabinetry or other decor.

- Maximum panel thickness 1/4"
- Minimum panel thickness 1/8"

Notch all four corners of panel

Custom Trim

Model No.	Black Trim No.	Custom Panel Insert Cut-Out Dimensions (Inches)	
		A	B
GMRO6AAM	TK6	29	22-3/4

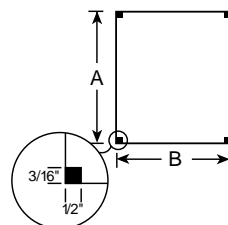

Answers that click!  
GE puts everything you need at your fingertips.



**GE Appliances web site — 16 million visitors a year!  
Visit us at [GEAppliances.com](http://GEAppliances.com)**

Everything you need to know about GE products is here. Access up-to-date information, find out "what's new," obtain dimensions, get installation tips and more. Extremely user-friendly, this one-stop site lets you research by brand, category or model number and even buy online through a local GE dealer.

**GE Answer Center® saves you time.  
800.626.2000**

This 24-hour-a-day, 7-day-a-week service provides answers on product features, installation, service and more.



**A Century of Quality and Innovation**

For more than a century, GE has been committed to producing innovative products that change the way people live. The result of thorough research and rigorous testing, GE appliances are designed for years of dependable performance. Today, the GE tradition of quality and innovation continues.



**GE Appliances**

GE Consumer Products  
General Electric Company  
Louisville, Kentucky 40225  
[GEAppliances.com](http://GEAppliances.com)

Before purchasing an appliance, read important information about its estimated annual energy consumption or energy efficiency rating that is available from your retailer or [GEAppliances.com](http://GEAppliances.com)

GE has a policy of continuous improvement of its products and reserves the right to change materials and specifications without notice.

© 2002 General Electric Company  
Pub. No. 2-S033 PC34573