



brightspace™ interior • customcool™ technology • 2004 product specifications • turbocool™ setting • tall lighttouch! dispenser •

GE Profile™ and GE® Refrigerators

The Ultimate in Refrigeration.™
Rethought. Reinvented. Revolutionized.

imagination at work



The Ultimate in Refrigeration.™





GE Profile Arctica® has the freshest ideas in refrigeration, including the new **ClimateKeeper2™ dual-evaporator system** which carefully controls humidity to keep foods **fresh days longer**. The **stylish exterior** makes a **dramatic** statement, and the multilevel interior makes **versatile** use of every inch of storage space. In the freshfood compartment, slide-out shelves **simplify** loading and unloading. In the freezer compartment, the ice system is **uniquely** designed to allow more room for more food. In addition to **innovative** storage features, both compartments offer a range of cooling capabilities for the ultimate in **flexibility** and **performance**.



Feature Gallery: Built-In Side-by-Sides



ENERGY STAR®-qualified
 Reduces energy usage below federal energy standards by 15% or more, for a high-efficiency design that can help lower utility bills.



ClimateKeeper™ System

Combines electronic touch controls, multiple electronic sensors and a multiflow air system to keep temperatures consistent and help preserve foods.



Digital temperature controls

Located on the dispenser to provide easy-access and electronic accuracy in controlling fresh food and freezer compartment temperatures.



Soft-touch dispenser

Dispenses water and ice with gentle pressure, complete with safety and convenience features such as a child lock and door alarm, filter replacement indicator light and QuickIce™ system.

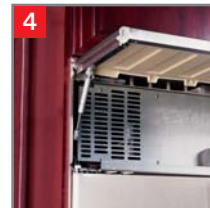

Overhead evaporator system

Provides additional freezer space, eliminates shared air and reduces defrosting. Access panel easily lifts out of the way for convenient replacement of the water filter.



Adjustable humidity vegetable/fruit crispers

Customizes the storage environment to keep fruits and vegetables at their best.

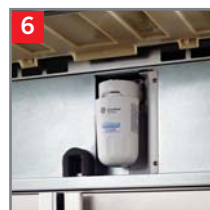

SmartWater™ Plus filtration

Ensures access to clear, better-tasting water and ice with filter change indicator light and simple-to-install Twist and Lock design.



Spillproof glass shelves

Contains spills to keep cleanup to a minimum.

Built-In Side-By-Side Refrigerators



PSB42LSR

GE Profile Arctica® 25.2 cu. ft. Refrigerator

- 42" built-in configuration
- ClimateKeeper™ system
- Electronic dispenser with digital temperature display
- Soft-touch dispenser with child lock and door alarm
- SmartWater™ Plus filtration system
- FrostGuard™ technology
- Quick Ice™ feature

- PSB42LSRBV
- PSB42LGRWV
- PSB42LGRBV



- Stainless steel
- White
- Black

Built-in refrigerators with installed trim accept acrylic panels in white or black which can be ordered from GE. To achieve a custom look, you can order 1/4" or 3/4" wood panels from your cabinetmaker. You'll discover all kinds of ways to enhance your kitchen. Our trimless unit, which comes in stainless steel, simply slides into the space between cabinets. It instantly looks built-in with nothing to attach or build.



PSB42LGRWV
shown with optional white acrylic panels



PSB42LGRBV
shown with optional black acrylic panels



PSB42LGRWV
shown with optional 1/4" custom wood panels



PSB42LGRBV
shown with optional 1/4" custom wood panels



PSB42LGRWV
shown with optional 3/4" custom wood panels



PSB42LGRBV
shown with optional 3/4" custom wood panels

Acrylic Panels

Model No.	Black Acrylic Panels	White Acrylic Panels
PSB42LGRWV		PSPK42DWW
PSB42LGRBV	PSPK42DBB	

Feature Gallery: Side-by-Sides





1 **ClimateKeeper2™ System**
Keeps foods fresh longer, while protecting ice from odor transfer, with its unique dual-evaporator system.



2 **Only GE has it!**
Upfront digital controls with temperature readout
Are precise and easy to use.



3 **TurboCool™ feature**
Quickly cools the refrigerator after frequent door openings or when hot items are placed inside.



4 **SmartWater™ filtration system**
Delivers clean, great-tasting water and ice through the LightTouch! dispenser.



5 **In-the-door beverage rack**
Conveniently located inside the refrigerator door to increase flexibility and free up valuable shelf space.

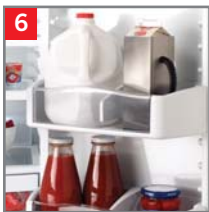

6 **Adjustable ClearLook™ bins**
Hold gallon-size containers with style and ease.



7 **Slide-out, spillproof glass shelves**
Simplify loading, unloading and cleaning.



8 **Only GE has it!**
Full-extension bin with CustomCool™ technology
Chills in minutes, thaws in hours and helps keep foods fresher, longer. For added convenience, it opens fully to allow easy access.

Limited lifetime warranty* on slides. See written warranty for details.



9 **Only GE has it!**
Integrated Ice™ system
The ice bucket is integrated into the icemaker, not the freezer door, freeing up valuable storage space. It pulls out and down, providing easy access to cubed ice.



10 **Only GE has it!**
Slide 'n Store™ full-extension freezer baskets
Extend 16" for easy loading and unloading.



11 **QuickSpace™ shelf**
Quickly slides out of the way to make room for tall items.



Tall LightTouch! dispenser
Accommodates tall glassware and dispenses water and ice at the slightest touch.

GE Profile Arctica® and GE CustomStyle™ Side-by-Sides

An impressive design statement, without standing out.

For a built-in look, without the built-in expense, here's a fitting solution. A GE Profile CustomStyle™ refrigerator makes the most of your kitchen space by blending in almost seamlessly with surrounding cabinetry. It gives you the style you want and features you need, without the cost and inconvenience of remodeling. For a sleek, modern appearance, choose stainless or acrylic panels. Or, achieve a custom look with cabinet-matching wood panels. Whatever style you prefer, you'll find a CustomStyle refrigerator that works beautifully with your decor and budget.



Installed-trim side-by-side models

Designed for today's discriminating consumers.

CustomStyle refrigerators with installed trim accept stainless steel or acrylic panels in white, black or bisque, all of which can be ordered from GE. To achieve a custom look, you can order wood panels from your cabinetmaker. You'll discover all kinds of ways to enhance your kitchen.



Optional Panels

Choose stainless steel panels or acrylic panels in white, bisque or black.



Custom Wood Panels

Make and install your own custom wood panels to accent cabinetry.

Optional collar trim: adding the final touch.

The optional collar trim is just another way GE lets you integrate our CustomStyle refrigerators into your kitchen decor. Available in stainless steel, white, bisque and black, this trim frames the refrigerator facade, adding to the finished look of a built-in, custom kitchen.

Collar Trim

Model No.	Black Collar Trim	White Collar Trim	Bisque Collar Trim	Stainless Steel Collar Trim
PSI23NCP	TRMBISBB	TRMBISWW	TRMBISCC	TRMBISS
PSI23SCR				TRMBISS
PSI23MGP	TRMBISBB	TRMBISWW	TRMBISCC	TRMBISS
PSI23NGP	TRMBISBB	TRMBISWW	TRMBISCC	TRMBISS
PSI23SGR				TRMBISS

Acrylic and Stainless Steel Panels

Model No.	Black Acrylic Panels	White Acrylic Panels	Bisque Acrylic Panels	Stainless Steel Panels
PSI23NCP	PSPK23CBB	PSPK23CWW	PSPK23CCC	-
PSI23MGP	PSPK23DBB	PSPK23DWW	PSPK23DCC	PSPK23DSS
PSI23NGP	PSPK23DBB	PSPK23DWW	PSPK23DCC	PSPK23DSS

Trimless side-by-side models

Installation made easy: simply slide in.

Trimless CustomStyle units install by simply sliding into—way into—the space between cabinets. They align with counters, instantly look built-in, with nothing to attach or build. (Available in stainless steel, white, bisque and black.)



Installed-trim side-by-side models

Dispenser Models



PSH23PGR
Shown with optional black acrylic panels. Available in white, bisque or black.

Model PSH23PGR is ENERGY STAR®-qualified.



PSI23NGP
Shown with custom wood panels. Available in white, bisque or black.



PSI23MGP
Shown with optional white acrylic panels. Available in white, bisque or black.



PSI23MGP
Shown with custom wood panels. Available in white, bisque or black.

Non-Dispenser Models



PSI23NCP
Shown with optional white acrylic panels. Available in white, bisque or black.



PSI23NCP
Shown with custom wood panels. Available in white, bisque or black.

Trimless side-by-side models

Dispenser Models



PSW23PSR
Stainless-wrapped with sculptured stainless steel handles.

Model PSW23PSR is ENERGY STAR®-qualified.



PSC23SHR
Stainless steel with sculptured stainless steel handles.



PSC23NHP
Available in white, bisque or black.



PSC23SGR
Stainless steel with sculptured stainless steel handles.



**PSC23NGP/
PSC23MGP**
Available in white, bisque or black.



PSH23PSR/PSI23SGR
Stainless steel with full-length visor handles.

Model PSH23PSR is ENERGY STAR®-qualified.

Non-Dispenser Model



GSC23LSR
Stainless steel with tubular handles. Available in stainless or white and black as GSC23LGQ.



GSC21KGR
Available in white or black.



PSI23SCR
Stainless steel with full-length visor handles.

Side-By-Side Refrigerators



PSW23PSR

GE Profile Arctica CustomStyle™ 22.6 cu. ft. Stainless-Wrapped Refrigerator

- ClimateKeeper2™ system
- CustomCool™ technology with full-extension drawer
- Upfront electronic touch temperature controls with digital temperature display
- Integrated Ice™ system
- LightTouch! tall dispenser with child lock and door alarm
- Slide 'n Store™ full-extension freezer baskets
- FrostGuard™ technology





 PSW23PSRSS



PSH23PSR

GE Profile Arctica CustomStyle™ 22.6 cu. ft. Refrigerator

- **ClimateKeeper2 system**
- CustomCool technology with full-extension drawer
- Upfront electronic touch temperature controls with digital temperature display
- Integrated Ice system
- LightTouch! tall dispenser with child lock and door alarm
- Slide 'n Store full-extension freezer baskets
- FrostGuard technology

-  PSH23PSRSV trimless
-  PSH23PGRWW installed trim
-  PSH23PGRCC installed trim
-  PSH23PGRBB installed trim











 Stainless steel  White  Bisque  Black



PSI23SGR

GE Profile Arctica CustomStyle 22.6 cu. ft. Installed-Trim Refrigerator

- CustomCool technology with full-extension drawer
- ClimateKeeper™ system
- Upfront electronic touch temperature controls with digital temperature display
- Integrated Ice system
- LightTouch! tall dispenser with child lock and door alarm
- Slide 'n Store full-extension freezer baskets
- FrostGuard technology



-  PSI23SGRSV
-  PSI23NGPWW
-  PSI23NGPCC
-  PSI23NGPBB
-  PSI23SCRSV
non-dispenser model
-  PSI23NCPWW
non-dispenser model
-  PSI23NCPCC
non-dispenser model
-  PSI23NCPBB
non-dispenser model



PSI23MGP

GE Profile Arctica CustomStyle 22.7 cu. ft. Installed-Trim Refrigerator

- ClimateKeeper system
- Upfront electronic touch temperature controls
- Integrated Ice system
- LightTouch! tall dispenser with child lock and door alarm
- Integrated shelf support system
- FrostGuard technology
- Slide-out spillproof glass shelves

-  PSI23MGPWW
-  PSI23MGPCC
-  PSI23MGPBB

Side-By-Side Refrigerators



PSC23SGR

GE Profile Arctica CustomStyle™ 22.6 cu. ft. Trimless Refrigerator

- **CustomCool™** technology with full-extension drawer
- ClimateKeeper™ system
- **Upfront electronic touch temperature controls with digital temperature display**
- Integrated Ice™ system
- LightTouch! tall dispenser with child lock and door alarm
- **Slide 'n Store™ full-extension freezer baskets**
- FrostGuard™ technology

○ PSC23SGRSS

○ PSC23NGPWW

○ PSC23NGPCC

● PSC23NGPBB

○ PSC23SHRSS
black dispenser and refreshment center model

○ PSC23NHPWW
refreshment center model

○ PSC23NHPCC
refreshment center model

● PSC23NHPBB
refreshment center model



PSC23MGP

GE Profile Arctica CustomStyle™ 22.7 cu. ft. Trimless Refrigerator

- **ClimateKeeper system**
- Upfront electronic touch temperature controls
- Integrated Ice system
- LightTouch! tall dispenser with child lock and door alarm
- FrostGuard technology
- Integrated shelf support system
- Slide-out, spillproof glass shelves

○ PSC23MGPWW

○ PSC23MGPC

● PSC23MGPBB

○ Stainless steel ○ White ○ Bisque ● Black



GSC23LSR

GE CustomStyle 22.7 cu. ft.
Trimless Refrigerator

- Upfront electronic touch temperature controls
- **Integrated Ice system**
- **TurboCool™ setting**
- **LightTouch! tall dispenser with child lock and door alarm**
- SmartWater™ Plus filtration system
- FrostGuard technology
- **QuickSpace™ shelf**

- GSC23LSRSS
- GSC23LGQWW
- GSC23LGQBB



GSC21KGR

GE CustomStyle 21.4 cu. ft.
Trimless Refrigerator

- Upfront electronic touch temperature controls
- LightTouch! tall dispenser with child lock
- FrostGuard technology
- Slide-out, spillproof glass shelves
- SmartWater Plus filtration system
- Adjustable humidity vegetable/fruit crisper
- Adjustable gallon door bins

- GSC21KGRWW
- GSC21KGRBB

○ Stainless steel ○ White ● Black

Side-By-Side Refrigerators



PSW26SGR

GE Profile Arctica® 25.5 cu. ft. Stainless-Wrapped Refrigerator

- ClimateKeeper™ system
- CustomCool™ technology with full-extension drawer
- Upfront electronic touch temperature controls with digital temperature display
- Integrated Ice™ system
- LightTouch! tall dispenser with child lock and door alarm
- Slide 'n Store™ full-extension freezer baskets
- FrostGuard™ technology

○ PSW26SGRSS



PSF26NGP

GE Profile Arctica 25.5 cu. ft. High-Gloss Refrigerator

- **ClimateKeeper system**
- CustomCool technology with full-extension drawer
- Upfront electronic touch temperature controls with digital temperature display
- Integrated Ice system
- LightTouch! tall dispenser with child lock and door alarm
- Contoured doors
- Slide 'n Store full-extension freezer baskets

○ PSF26NGPWW

○ PSF26NGPCC

● PSF26NGPBB



○ Stainless steel ○ White ○ Bisque ● Black



PSS29NHP

GE Profile Arctica 28.7 cu. ft. Refrigerator

- Refreshment Center
- ClimateKeeper system
- CustomCool technology with full-extension drawer
- Upfront electronic touch temperature controls with digital temperature display
- Integrated Ice system
- LightTouch! tall dispenser with child lock and door alarm
- Contoured doors

- PSS29NHPWW
- PSS29NHPCC
- PSS29NHPBB



PSS26SHR

GE Profile Arctica 25.5 cu. ft. Refrigerator

- Refreshment Center
- CustomCool technology with full-extension drawer
- ClimateKeeper system
- Upfront electronic temperature controls with digital temperature display
- Integrated Ice system
- LightTouch! tall dispenser with child lock and door alarm
- Contoured doors

- PSS26SHRSS
- PSS26NHPWW
- PSS26NHPCC
- PSS26NHPBB



Side-By-Side Refrigerators



PSS29NGP

GE Profile Arctica® 28.6 cu. ft. Refrigerator

- CustomCool™ technology with full-extension drawer
- ClimateKeeper™ system
- Upfront electronic touch temperature controls with digital temperature display
- Integrated Ice™ system
- LightTouch! tall dispenser with child lock and door alarm
- Contoured doors
- Slide 'n Store™ full-extension freezer baskets

 PSS29NGPWW

 PSS29NGPCC

 PSS29NGPBB



PSS26SGR

GE Profile Arctica 25.5 cu. ft. Refrigerator

- CustomCool technology with full-extension drawer
- ClimateKeeper system
- **Upfront electronic touch temperature controls with digital temperature display**
- Integrated Ice system
- LightTouch! tall dispenser with child lock and door alarm
- Contoured Doors
- Slide 'n Store full-extension freezer baskets

 PSS26SGRSS

 PSS26NGPWW

 PSS26NGPCC

 PSS26NGPBB



PSS27SGR (not shown)

Similar to the PSS26SGR with 26.5 cu. ft. capacity and is not ENERGY STAR® qualified

 PSS27SGRSS

 PSS27NGPWW

 PSS27NGPCC

 PSS27NGPBB

 Stainless steel  White  Bisque  Black



PSS26MGP

GE Profile Arctica 25.5 cu. ft. Refrigerator

- **ClimateKeeper system**
- Upfront electronic touch temperature controls
- Integrated Ice system
- LightTouch! tall dispenser with child lock and door alarm
- FrostGuard™ technology
- Contoured doors
- Integrated shelf support system

- PSS26MSRSS
- PSS26MGPWW
- PSS26MGPCC
- PSS26MGPBB



PSS26LSR

GE Profile Arctica 25.6 cu. ft. Refrigerator

- Upfront electronic touch temperature controls
- **Integrated Ice system**
- **TurboCool™ setting**
- **LightTouch! tall dispenser with child lock and door alarm**
- SmartWater™ Plus water filtration system
- FrostGuard technology
- **Integrated shelf support system**

- PSS26LSRSS
- PSS26LGRWW
- PSS26LGRCC
- PSS26LGRBB



- Stainless steel
- White
- Bisque
- Black

Side-By-Side Refrigerators



GSH25KGR

GE® 25.0 cu. ft. Refrigerator

- Upfront electronic touch temperature controls
- Adjustable slide-out, spillproof glass shelves
- LightTouch! tall dispenser with child lock
- SmartWater™ Plus filtration system
- FrostGuard™ technology
- Adjustable humidity vegetable/fruit crisper
- Adjustable temperature deli pan

- GSH25SGRSS
- GSH25KGRWW
- GSH25KGRCC
- GSH25KGRBB



GSH22SGR (not shown)

Similar to the GSH25SGR with 21.9 cu. ft. capacity

- GSH22SGRSS
- GSH22KGRWW
- GSH22KGRCC
- GSH22KGRBB



GSS25SGR

GE 25.0 cu. ft. Refrigerator

- Upfront electronic touch temperature controls
- Adjustable slide-out, spillproof glass shelves
- **LightTouch! tall dispenser with child lock**
- **SmartWater Plus filtration system**
- FrostGuard technology
- **Adjustable humidity vegetable/fruit crisper**
- Adjustable temperature deli drawer

- GSS25SGRSS
- GSS25KGPWW
- GSS25KGPCC
- GSS25KGPBB

GSS22SGR (not shown)

Similar to the GSS25SGR with 21.9 cu. ft. capacity

- GSS22SGRSS
- GSS22KGPWW
- GSS22KGPCC
- GSS22KGPBB





○ Stainless steel ○ White ○ Bisque ● Black



GSL25JFP



GE 25.0 cu. ft. Refrigerator

- **CleanSteel™ exterior (GSL25JFP and GSL22JFP only)**
- Upfront electronic temperature controls
- Adjustable spillproof glass shelves
- LightTouch! tall dispenser
- SmartWater filtration system
- Sealed vegetable/fruit crisper
- Adjustable temperature deli drawer

-  **GSL25JFPBS**
-  **GSS25JFPWW**
-  **GSS25JFPCC**
-  **GSS25JFPBB**

GSL22JFP (not shown)

Similar to the GSL25JFP with 21.9 cu. ft. capacity

-  **GSL22JFPBS**
-  **GSS22JFPWW**
-  **GSS22JFPCC**
-  **GSS22JFPBB**



GSS25JEP

GE 25.0 cu. ft. Refrigerator

- Upfront electronic temperature controls
- **Adjustable spillproof glass shelves**
- LightTouch! tall dispenser
- Sealed vegetable/fruit crisper
- **Adjustable temperature deli drawer**
- Adjustable gallon door bins
- FrostGuard technology

-  **GSS25JEPWW**
-  **GSS25JEPCC**
-  **GSS25JEPBB**

GSS22JEP (not shown)

Similar to the GSS25JEP with 22.0 cu. ft. capacity

-  **GSS22JEPWW**
-  **GSS22JEPCC**
-  **GSS22JEPBB**

Side-By-Side Refrigerators



GSS25IFP

GE® 25.0 cu. ft. Refrigerator

- Upfront electronic temperature controls
- Adjustable glass shelves
- **LightTouch! tall dispenser with SmartWater™ filtration**
- Sealed vegetable/fruit crisper
- Sealed deli drawer
- Adjustable gallon door bins
- FrostGuard™ technology

○ GSS25IFPWW

○ GSS25IFPCC

● GSS25IFPBB

GSS22IFP (not shown)

Similar to the GSS25IFP with 22.0 cu. ft. capacity

○ GSS22IFPWW

○ GSS22IFPCC

● GSS22IFPBB



GSS20IEP

GE 20.0 cu. ft. Refrigerator

- Upfront electronic temperature controls
- Adjustable glass shelves
- **LightTouch! tall dispenser**
- Sealed vegetable/fruit crisper
- Sealed meat drawer
- Adjustable gallon door bins
- FrostGuard technology

○ GSS20IEPWW

○ GSS20IEPCC

● GSS20IEPBB

○ White ○ Bisque ● Black



GSS22IBP

GE 21.9 cu. ft. Refrigerator

- Upfront electronic temperature controls
- Adjustable glass shelves
- Sealed vegetable/fruit crisper
- Sealed meat drawer
- Adjustable gallon door bins
- FrostGuard technology
- Deluxe quiet design

 GSS22IBPWW

 GSS22IBPCC

GSS20IBP (not shown)

Similar to the GSS22IBP with 19.9 cu. ft. capacity

 GSS20IBPWW

 GSS20IBPCC



GSS20DBP

GE 19.9 cu. ft. Refrigerator

- Upfront electronic temperature controls
- Sealed vegetable/fruit crisper
- Sealed meat drawer
- Gallon door storage
- FrostGuard technology
- Deluxe quiet design
- NeverClean™ condenser

 GSS20DBPWW

 GSS20DBPCC

 White  Bisque

Feature Gallery: Bottom-Freezers





New!

Internal water dispenser

Provides chilled, great tasting filtered water on demand, from inside the refrigerator.



Slide-out, spillproof glass shelves

Simplify loading, unloading and cleaning.



Adjustable temperature deli drawer

Provides a convenient, temperature-controlled place for meats, cheeses and other favorite foods.



Adjustable ClearLook™ crispers

Provide the ideal storage environment for fruits and vegetables, with humidity controls and transparent fronts.



Upfront electronic controls with digital temperature readout

Are precise and easy to use. Take the guesswork out of selecting accurate temperatures.



Only GE has it!

ClimateKeeper™ system

Combines upfront electronic touch controls, multiple electronic sensors and a multiflow air system to keep temperatures consistent and help keep foods fresh.



QuickSpace™ shelf

Quickly slides out of the way to make room for tall items.



ClearLook™ gallon door bins

Hold gallon-size containers with style and ease.



ShelfSaver™ beverage rack

Provides convenient storage for a 12-pack, two egg cartons or a 9"x 13" casserole dish.



ENERGY STAR®-qualified

Higher energy efficiency means lower utility bills. 20 and 22 cu. ft. models are 33% better than 2004 ENERGY STAR standards.

Bottom-Freezer Refrigerators



PDW22SHR

GE Profile Arctica® 22.2 cu. ft. Stainless-Wrapped Drawer Refrigerator

- **Internal water dispenser with GE SmartWater™ filtration**
- Upfront electronic touch temperature controls with digital temperature display
- ClimateKeeper™ system
- Multi-level Slide 'n Store™ freezer baskets
- Integrated icemaker
- BrightSpace™ interior with GE Reveal™ lighting
- ShelfSaver™ beverage rack

 **PDW22SHRSS**

Available July 2004



PDW22SCR

GE Profile Arctica 22.2 cu. ft. Stainless-Wrapped Drawer Refrigerator

- Upfront electronic touch temperature controls with digital temperature display
- ClimateKeeper system
- Multi-level Slide 'n Store freezer baskets
- Integrated icemaker with GE SmartWater filtration
- BrightSpace interior with GE Reveal lighting
- ShelfSaver beverage rack
- QuickSpace™ shelf

 **PDW22SCRSS**

Discontinues July 2004



 Stainless steel



PDF22MCR

GE Profile Arctica 22.2 cu. ft. High-Gloss Smooth Drawer Refrigerator

- Upfront electronic touch temperature controls with digital temperature display
- ClimateKeeper system
- Multi-level Slide 'n Store freezer baskets
- Integrated icemaker with GE SmartWater filtration
- BrightSpace interior with GE Reveal lighting
- ShelfSaver beverage rack
- QuickSpace shelf

 PDF22MCRWW

 PDF22MCRBB



PDS22MHR

GE Profile Arctica 22.2 cu. ft. Drawer Refrigerator

- Internal water dispenser with GE SmartWater filtration
- Upfront electronic touch temperature controls with digital temperature display
- ClimateKeeper system
- Multi-level Slide 'n Store freezer baskets
- Integrated icemaker
- BrightSpace interior with GE Reveal lighting
- ShelfSaver beverage rack

 PDS22SHRSS

 PDS22MHRWW

 PDS22MHRCC

 PDS22MHRBB



Available July 2004

Bottom-Freezer Refrigerators



PDS22SCR

GE Profile Arctica® 22.2 cu. ft. Drawer Refrigerator

- Upfront electronic touch temperature controls with digital temperature display
- ClimateKeeper™ system
- Multi-level Slide 'n Store™ freezer baskets
- **Integrated icemaker with GE SmartWater™ filtration**
- BrightSpace™ interior with GE Reveal™ lighting
- ShelfSaver™ beverage rack
- QuickSpace™ shelf

- PDS22SCRSS
- PDS22MCRWW
- PDS22MCRCC
- PDS22MCRBB



Discontinues July 2004



PDS22MBR

GE Profile Arctica 22.2 cu. ft. Drawer Refrigerator

- Upfront electronic touch temperature controls with digital temperature display
- ClimateKeeper system
- Multi-level Slide 'n Store freezer baskets
- BrightSpace interior with GE Reveal lighting
- ShelfSaver beverage rack
- QuickSpace shelf
- Self-closing drawer

- PDS22SBRSS
- PDS22MBRWW
- PDS22MBRCC
- PDS22MBRBB



○ Stainless steel ○ White ○ Bisque ● Black



PDS20SCR

GE Profile Arctica 19.5 cu. ft. Drawer Refrigerator

- Upfront electronic touch temperature controls with digital temperature display
- ClimateKeeper system
- Multi-level Slide 'n Store freezer baskets
- Integrated icemaker with GE SmartWater filtration
- BrightSpace interior with GE Reveal lighting
- ShelfSaver beverage rack
- Self-closing drawer

- PDS20SCRSS
- PDS20MCRWW
- PDS20MCRCC
- PDS20MCRBB



- PDS20SBRSS non-icemaker model
- PDS20MBRWW non-icemaker model
- PDS20MBRCC non-icemaker model
- PDS20MBRBB non-icemaker model



GBS22KBR

GE® 22.3 cu. ft. Door Refrigerator

- Upfront illuminated temperature controls
- Slide 'n Store freezer basket
- Adjustable gallon door bins
- BrightSpace interior with GE Reveal lighting
- Adjustable spillproof glass shelves
- Adjustable humidity vegetable/fruit crispers
- Snack pan

- GBS22KBRWW
- GBS22KBRCC
- GBS22KBRBB



GBS20KBR (not shown)

Similar to the GBS22KBR with 19.5 cu. ft. capacity

- GBS20KBRWW
- GBS20KBRCC
- GBS20KBRBB



○ Stainless steel ○ White ○ Bisque ● Black

Bottom-Freezer Refrigerators



GBS22HCR

GE® 22.3 cu. ft. Door Refrigerator

- Upfront illuminated temperature controls
- **Integrated Icemaker**
- Gallon door storage
- BrightSpace™ interior with GE Reveal™ lighting
- Adjustable glass shelves
- Snack pan
- Deluxe quiet design

 GBS22HCRWW

 GBS22HCRCC

 GBS22HCRBB



GBS22HBR

GE 22.3 cu. ft. Door Refrigerator

- Upfront illuminated temperature controls
- Gallon door storage
- **BrightSpace interior with GE Reveal lighting**
- Adjustable glass shelves
- Snack pan
- Deluxe quiet design
- NeverClean™ condenser

 GBS22HBRWW

 GBS22HBRCC

 GBS22HBRBB



 White  Bisque  Black



GDS18SCR

GE 18.1 cu. ft. Drawer Refrigerator

- Brita® filtered water door module
- Adjustable humidity vegetable/fruit crispers
- Adjustable spillproof glass shelves
- Slide 'n Store™ freezer basket
- Factory-installed automatic icemaker
- Adjustable gallon door bins
- Snack pan

 GDS18SCRSS

 GDS18LCRWW

 GDS18LCRCC

 GDS18LCRBB



 GDS18SBRSS
non-icemaker model

 GDS18LBRWW
non-icemaker model

 GDS18LBRCC
non-icemaker model

 GDS18LBRBB
non-icemaker model



GBS18HBR

GE 18.1 cu. ft. Door Refrigerator

- Slide 'n Store freezer basket
- Gallon door storage
- Adjustable glass shelves
- Snack pan
- NeverClean™ condenser
- Deluxe quiet design
- Equipped for optional automatic icemaker

 GBS18HBRWW

 GBS18HBRCC

 GBS18HBRBB



 Stainless steel  White  Bisque  Black

GE Profile CustomStyle™ Top-Freezers

An impressive design statement, without standing out.

If you want a built-in look, but can't afford the built-in expense, here's a fitting solution. A GE Profile CustomStyle refrigerator makes the most of your kitchen space by blending in almost seamlessly with surrounding cabinetry. It gives you the style you want and features you need, without the cost and inconvenience of a kitchen redo. For a sleek, modern appearance, choose stainless or acrylic panels. Or, achieve a custom look with cabinet-matching wood panels. Whatever style you prefer, you'll find a CustomStyle refrigerator that works beautifully with your decor and budget.

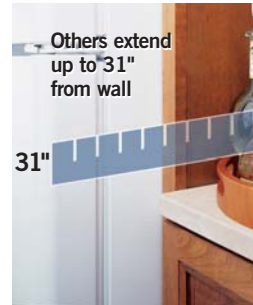

Installed-trim top-freezer models

Designed for today's discriminating consumers.

CustomStyle refrigerators with installed trim accept stainless steel or acrylic panels in white or black, all of which can be ordered from GE. To achieve a custom look, you can order wood panels from your cabinetmaker. You'll discover all kinds of ways to enhance your kitchen.



Optional Panels

Choose stainless steel panels or acrylic panels in white or black.



Custom Wood Panels

Make and install your own custom wood panels to accent cabinetry.

Optional collar trim: adding the final touch.

The optional collar trim is just another way GE lets you integrate our CustomStyle refrigerators into your kitchen decor. Available in stainless steel, white and black, this trim frames the refrigerator facade, adding to the finished look of a built-in, custom kitchen.

Acrylic Panels and Trim

Model No.	Black Acrylic Panels	White Acrylic Panels	Stainless Steel Panels	Black Collar Trim	White Collar Trim	Stainless Steel Trim
PTI22MBM	PTPK22CBB	PTPK22CWW	PTPK22CSS	TRMBISBB	TRMBISWW	TRMBISSS
PTI22MFM	PTPK22DBB	PTPK22DWW	PTPK22DSS	TRMBISBB	TRMBISWW	TRMBISSS

Trimless top-freezer models

Installation made easy: simply slide in.

Trimless CustomStyle units install by simply sliding into—way into—the space between cabinets. They align with counters and instantly look built-in, with nothing to attach or build. (Available in stainless steel, white, bisque and black.)



Installed-trim top-freezer models

Dispenser Models



PTI22SFM
Shown with installed stainless steel panels.



PTI22MFM
Shown with optional white acrylic panels. Available in white or black.



PTI22MFM
Shown with optional stainless steel panels. Available in white or black.



PTI22MFM
Shown with custom wood panels. Available in white or black.

Non-Dispenser Models



PTI22MBM
Shown with optional black acrylic panels. Available in white or black.



PTI22MBM
Shown with optional stainless steel panels. Available in white or black.



PTI22MBM
Shown with custom wood panels. Available in white or black.

Trimless top-freezer models

Dispenser Models



PTC22SFM
Stainless steel.



PTC22MFM
Available in white, bisque or black.



PTC22SBM
Stainless steel.



PTC22MBM
Available in white or black.

Feature Gallery: Top-Freezers





1 **Internal water dispenser**
Provides chilled, great tasting filtered water on demand, from inside the refrigerator.



2 **Adjustable temperature deli drawer**
Provides a convenient, temperature-controlled place for meats, cheeses and other favorite foods.



3 **Slide-out, spillproof glass shelves**
Simplify loading, unloading and cleaning.



Only GE has it!
Electronic touch controls with digital temperature readout
Precise and easy to use. Take the guesswork out of selecting accurate temperatures.



5 **ShelfSaver™ beverage rack**
Provides convenient storage for a 12-pack, two egg cartons or a 9"x 13" casserole dish.



6 **Adjustable ClearLook™ gallon door bins**
Hold large containers with style and ease.



7 **Adjustable humidity crispers**
Provide the ideal storage environment for fruits and vegetables.



GE SmartWater™ and ice filtration
Delivers clean, fresh-tasting water through the internal water dispenser.



Only GE has it!
FrostGuard™ technology
Defrosts only when needed, reducing freezer burn.

Top-Freezer Refrigerators



PTI22SFM

GE Profile CustomStyle™ 21.7 cu. ft. Installed-Trim Refrigerator

- Upfront illuminated temperature controls
- LightTouch! dispenser
- SmartWater™ filtration
- Factory-installed electronic icemaker
- Adjustable slide-out, spillproof glass shelves
- QuickSpace™ shelf
- Snack pan

 **PTI22SFMBS**

 **PTI22MFMWW**

 **PTI22MFMBB**

PTI22MBM (not shown)

Similar to the PTI22SFM with 21.9 cu. ft. capacity, except without dispenser and icemaker

 **PTI22MBMWW**

 **PTI22MBMBB**



PTC22SFM

GE Profile CustomStyle 21.7 cu. ft. Trimless Refrigerator

- Upfront illuminated temperature controls
- LightTouch! dispenser
- SmartWater filtration
- Factory-installed electronic icemaker
- Adjustable slide-out, spillproof glass shelves
- QuickSpace shelf
- Snack pan

 **PTC22SFMBS**

 **PTC22MFMWW**

 **PTC22MFMCC**

 **PTC22MFMBB**

PTC22SBM (not shown)

Similar to the PTC22SFM with 21.9 cu. ft. capacity, except without dispenser and icemaker

 **PTC22SBMBS**

 **PTC22MBMWW**

 **PTC22MBMBB**



 Stainless steel  White  Bisque  Black



PTS25SHR

GE Profile Arctica® 24.6 cu. ft. Refrigerator





- Internal water dispenser with SmartWater filtration
- Upfront electronic touch temperature controls with digital temperature display
- ClimateKeeper™ system
- Factory-installed automatic icemaker
- Adjustable slide-out, spillproof glass shelves
- ClearLook™ adjustable gallon door bins
- Tilt-out locking freezer door bin

-  PTS25SHRBS
-  PTS25LHRWW
-  PTS25LHRCC
-  PTS25LHRBB



PTS22SHR (not shown)

Similar to the PTS25SHR with 21.7 cu. ft. capacity





-  PTS22SHRBS
-  PTS22LHRWW
-  PTS22LHRCC
-  PTS22LHRBB



PTS22SCR

GE Profile Arctica 21.7 cu. ft. Refrigerator

- Upfront electronic touch temperature controls with digital temperature display
- ClimateKeeper system
- Factory-installed automatic icemaker
- Adjustable slide-out, spillproof glass shelves
- ClearLook adjustable gallon door bins
- Tilt-out locking freezer door bin
- Pivot-out pan removal system

-  PTS22SCRBS
-  PTS22LCRWW
-  PTS22LCRCC
-  PTS22LCRBB



Top-Freezer Refrigerators



GTH22SHR

GE® 21.7 cu. ft. Refrigerator

- **Internal water dispenser with GE SmartWater™ filtration**
- **Factory-installed automatic icemaker**
- Upfront illuminated slimline temperature controls
- Adjustable spillproof glass shelves
- Adjustable humidity vegetable/fruit crispers
- Adjustable gallon door bins
- Spillproof freezer floor



GTH22SHRBS



GTS22KHPWW
non ENERGY STAR® model



GTS22KHPCC
non ENERGY STAR® model



GTS22KHPBB
non ENERGY STAR® model

GTS18SHP (not shown)

Similar to the GTS22KHP with 17.9 cu. ft. capacity



GTS18SHPBS



GTS18KHPWW



GTS18KHPCC



GTS18KHPBB



GTS22KCP

GE 21.7 cu. ft. Refrigerator

- Upfront illuminated slimline temperature controls
- Adjustable spillproof glass shelves
- Factory-installed automatic icemaker
- Adjustable humidity vegetable/fruit crispers
- Spillproof freezer floor
- Adjustable gallon door bins
- Pivot-out pan removal system (21.7 cu. ft. models only)



GTS22KCPWW



GTS22KCPCC



GTS22KCPBB

GTS18KCP (not shown)

Similar to the GTS22KCP with 17.9 cu. ft. capacity



GTS18KCPWW



GTS18KCPCC



GTS18KCPBB

Stainless steel
 White
 Bisque
 Black



GTH22SBR

GE 21.7 cu. ft. Refrigerator

- Upfront illuminated slimline temperature controls
- Adjustable spillproof glass shelves
- Adjustable humidity vegetable/fruit crispers
- Adjustable gallon door bins
- Spillproof freezer floor
- Pivot-out pan removal system (21.7 cu. ft. models only)
- NeverClean™ condenser



GTH22SBRBS



GTH22KBRWW



GTS22KBPWW

non ENERGY STAR® model



GTS22KBPCC

non ENERGY STAR® model



GTS22KBPBB

non ENERGY STAR® model

GTH18KBR (not shown)

Similar to the GTH22KBR with 17.9 cu. ft. capacity



GTH18KBRWW



GTH18KBRCC



GTH18KBRBB



GTS18SBPBS

non ENERGY STAR® model



GTS18KBPWW

non ENERGY STAR® model



GTS18KBPCC

non ENERGY STAR® model



GTS18KBPBB

non ENERGY STAR® model



GTS16KBR

GE 15.8 cu. ft. Refrigerator

- Spillproof glass shelves
- Upfront temperature controls
- Adjustable humidity vegetable/fruit crispers
- Gallon door storage
- Freezer step shelf
- NeverClean™ condenser
- Deluxe quiet design



GTS16KBRWW



GTS16KBRCC

Stainless steel

White

Bisque

Black

Top-Freezer Refrigerators



GTS22JCP

GE® 21.8 cu. ft. Refrigerator

- Upfront illuminated slimline temperature controls
- Adjustable spillproof glass shelves
- Factory-installed automatic icemaker
- Sealed vegetable/fruit crispers
- Spillproof freezer floor
- Gallon door storage
- **Pivot-out pan removal system**

CS GTL22JCPBS

GTS22JCPWW

GTS22JCPCC

CS GTL22JBPBS
non-icemaker model

GTS22JBPWW
non-icemaker model

GTS22JBPCC
non-icemaker model



GTL18JCP

GE 17.9 cu. ft. Refrigerator

- CleanSteel™ exterior (GTL18JCP/GTL18JBP only)
- **Upfront illuminated slimline temperature controls**
- Adjustable spillproof glass shelves
- **Factory-installed automatic icemaker**
- Sealed vegetable/fruit crispers
- Spillproof freezer floor
- Gallon door storage

CS GTL18JCPBS

GTS18JCPWW

GTS18JCPCC

CS GTL18JBPBS
non-icemaker model

GTS18JBPWW
non-icemaker model

GTS18JBPCC
non-icemaker model

GTH18JBRWW
ENERGY STAR®-qualified, non-icemaker model

GTH18JBRC
ENERGY STAR®-qualified, non-icemaker model



CS CleanSteel ○ White ○ Bisque



GTL16JBR

GE 15.8 cu. ft. Refrigerator

- CleanSteel exterior (GTL16JBR only)
- Upfront temperature controls
- Spillproof glass shelves
- Adjustable humidity clear vegetable/fruit crispers
- Gallon door storage
- NeverClean™ condenser
- Deluxe Quiet Design





-  GTL16JBRBS
-  GTS16JBRWW
-  GTS16JBRCC
-  GTS16JBRBB



GTS18HBR

GE 17.9 cu. ft. Refrigerator

- Adjustable glass shelves
- Upfront temperature controls
- Clear vegetable/fruit crispers
- Gallon door storage
- Freezer step shelf
- NeverClean condenser
- Deluxe quiet design

-  GTS18HBRWW
-  GTS18HBRCC
-  GTS18HCRWW
icemaker model
-  GTS18HCRC
icemaker model

Top-Freezer Refrigerators



GTS18GBR

GE® 17.9 cu. ft. Refrigerator

- **Adjustable glass shelves**
- Upfront temperature controls
- Clear vegetable/fruit crispers
- Gallon door storage
- Freezer step shelf
- NeverClean™ condenser
- Deluxe quiet design

 **GTS18GBRWW**

 **GTR18GBRCC**

 **GTS18GCRWW**

icemaker model

 **GTS18GCRC**

icemaker model



GTS18FBR

GE 17.9 cu. ft. Refrigerator

- Upfront temperature controls
- Adjustable shelves, two wire, one glass
- **Clear vegetable/fruit crispers**
- **Gallon door storage**
- NeverClean condenser
- Deluxe quiet design
- Squared doors

 **GTS18FBRWW**

 **GTR18FBRCC**

 White  Bisque



GTS18EBR

GE 17.2 cu. ft. Refrigerator

- Upfront temperature controls
- Adjustable wire shelves
- Vegetable/fruit crispers
- Tall bottle door storage
- NeverClean condenser
- Deluxe quiet design
- Squared doors

 **GTS18EBRWW**

 **GTS18EBRCC**



GTR18BBR

GE 17.9 cu. ft. Refrigerator

- Upfront temperature controls
- Recessed handles
- Vegetable/fruit crispers
- Adjustable wire shelves
- Tall bottle door storage
- NeverClean™ condenser
- Deluxe quiet design

 **GTR18BBRWW**

 **GTR18BBRCC**

GTR17BBR (not shown)

Similar to the GTR18BBR with 17.2 cu. ft. capacity

 **GTR17BBRWW**

 **GTR17BBRCC**

GTR15BBR (not shown)

Similar to the GTR18BBR with 14.9 cu. ft. capacity

 **GTR15BBRWW**

 **GTR15BBRCC**

Top-Freezer Refrigerators



GTS17BCR

GE® 17.2 cu. ft. Refrigerator

- Upfront temperature controls
- Factory-installed automatic icemaker
- Two vegetable/fruit crispers
- Adjustable wire shelves
- Tall bottle door storage
- NeverClean condenser
- Deluxe quiet design

 **GTS17BCRWW**

 **GTS17BCRCC**

 **GTS17BBRWW**
non-icemaker model

 **GTS17BBRCC**
non-icemaker model



GTS15BBR

GE® 14.9 cu. ft. Refrigerator

- Upfront temperature controls
- **Two vegetable/fruit crispers**
- Adjustable wire shelves
- Tall bottle door storage
- NeverClean condenser
- Deluxe quiet design

 **GTS15BBRWW**

 **GTS15BBRCC**

 **GTS15BBRBB**

 **GTS15BCRWW**
icemaker model

 **GTS15BCRCC**
icemaker model

 **GTH15BBRWW**
ENERGY STAR®-qualified, non-icemaker model

 **GTH15BBRCC**
ENERGY STAR®-qualified, non-icemaker model



GTS12BBP

GE 11.9 cu. ft. Refrigerator

- Adjustable wire shelves
- Full-width divided vegetable/fruit crisper
- Tall bottle door storage
- Fixed freezer door shelves
- Equipped for optional automatic icemaker
- Dairy compartment
- Rounded doors

 **GTS12BBPWW**

 **GTS12BBPCC**

 White  Bisque  Black



GTS18ABR

GE 17.9 cu. ft. Refrigerator

- Upfront temperature controls
- Adjustable wire shelves
- Tall bottle door storage
- Full-width vegetable/fruit crisper
- NeverClean condenser
- Deluxe quiet design

○ GTS18ABRWW



GTR18ABR

GE 17.9 cu. ft. Refrigerator

- Upfront temperature controls
- Adjustable wire shelves
- Tall bottle door storage
- Recessed handles
- NeverClean condenser
- Deluxe quiet design

○ GTR18ABRWW



GTR11AAP

GE 11.4 cu. ft. Refrigerator

- Adjustable wire shelves
- Recessed handles
- Full-width vegetable/fruit crisper
- Tall bottle door storage
- Fixed freezer door shelves
- Rounded doors

○ GTR11AAPWW

○ White

Manual Defrost Refrigerator, Compact Refrigerators and Wine Cooler



GMS10AAM

GE® 9.7 cu. ft. Manual Defrost Refrigerator

- Adjustable wire shelves
- Full-width vegetable/fruit crisper
- Tall bottle storage

○ GMS10AAMWW



GE Spacemaker™ Compact Refrigerators

- Manual defrost
- Wire cabinet shelves
- Fresh food door shelves
- Ice 'N Easy trays

GMR06AAP

- 6.0 cu. ft. capacity
- Can rack
- Interior light
- Built-in capability

○ GMR06AAPWW

● GMR06AAPBB*

*Optional wood panel trim kit available.
(Installation option & model number on page 182.)

GMR04AAM

- 4.3 cu. ft. capacity
- Can rack
- Recessed handles

○ GMR04AAMWW

● GMR04AAMBB

GMR02BAN

- 1.7 cu. ft. capacity
- Recessed handles

○ GMR02BANWW

● GMR02BANBB



PWR04FAN

GE Profile™ 4.3 cu. ft. Wine Cooler

- Electronic adjustable controls
- 29 bottle capacity
- Slide-out shelves
- Clear glass door
- Interior light
- Lock
- Contoured door

○ PWR04FANBS

○ Stainless steel ○ White ● Black

Upright and Chest Freezers

GE Frost-Free Upright Freezers

- Adjustable temperature control
- Slide-out bulk storage basket
- Interior light
- Lock
- Limited food loss warranty
- Available in white only



FUF20DPWH

- 20.3 cu. ft. capacity
- 5 cabinet shelves (3 adj.)
- 6 door shelves (2 juice shelves)

FUF17DPWH

- 16.7 cu. ft. capacity
- 4 cabinet shelves (3 adj.)
- 5 door shelves (2 juice shelves)

FUF14DPWH

- 13.7 cu. ft. capacity
- 3 cabinet shelves (2 adj.)
- 5 door shelves (2 juice shelves)

GE Manual Defrost Upright Freezers

- Adjustable temperature control
- Interior light*
- Lock*
- Limited food loss warranty
- Available in white only



FUM21DPWH

- 20.6 cu. ft. capacity
- Slide-out bulk storage basket
- 5 cabinet shelves (1 adj.)
- 6 door shelves

FUM17DPWH

- 17.1 cu. ft. capacity
- Slide-out bulk storage basket
- 4 cabinet shelves (1 adj.)
- 5 door shelves

FUM14DPWH

- 14.1 cu. ft. capacity
- Slide-out bulk storage basket
- 4 cabinet shelves (1 adj.)
- 5 door shelves

*Not available on models FUM14SM or FUM5SN.

FUM14SMWH

- 14.1 cu. ft. capacity
- 3 cabinet shelves
- 5 door shelves

FUM5SNWH

- 5.0 cu. ft. capacity
- 2 cabinet shelves
- 3 door shelves

GE Manual Defrost Chest Freezers

- Adjustable temperature control
- Upfront defrost water drain
- Interior light*
- Lock*
- Limited food loss warranty
- Available in white only



*Not available on model FCM15SP.

FCM25RMWW

- 25.1 cu. ft. capacity
- 4 lift-out and sliding bulk storage baskets

FCM20DPWH

- 19.7 cu. ft. capacity
- 3 lift-out and sliding bulk storage baskets

FCM15DPWH

- 14.8 cu. ft. capacity
- 2 lift-out and sliding bulk storage baskets

FCM15SPWH

- 14.8 cu. ft. capacity
- 1 lift-out and sliding bulk storage basket

GE Manual Defrost Chest Freezers

- Adjustable temperature control
- Upfront defrost water drain
- Lock*
- Available in white only



*Not available on model FCM5SM.

FCM9DMWH

- 8.8 cu. ft. capacity
- 2 lift-out and sliding bulk storage baskets
- Interior light
- Limited food loss warranty

FCM7DNWH

- 7.0 cu. ft. capacity
- 2 lift-out and sliding bulk storage baskets
- Power "On" light
- Limited food loss warranty

FCM5DMWH

- 5.0 cu. ft. capacity
- 2 lift-out and sliding bulk storage baskets
- Power "On" light

FCM5SMWH

- 5.0 cu. ft. capacity
- 1 lift-out and sliding bulk storage basket

GE Profile™ Built-In Side-by-Side Refrigerators

	GE Profile™	
	PSB42LSR	PSB42LGR
Stainless steel model	●	
Capacity		
Total (cu. ft.)	25.2	25.2
Fresh food (cu. ft.)	15.6	15.6
Freezer (cu. ft.)	9.6	9.6
Shelf area (sq. ft.)	23.36	23.36
Fresh Food Features		
ClimateKeeper™ system	●	●
Multiflow air system	●	●
Upfront electronic digital display	●	●
Electronic touch temp. controls	Dispenser	Dispenser
Electronic sensors	●	●
SmartWater™ filtration system	Plus	Plus
SoftTouch dispenser	Crushed Ice, Cubes, Water	Crushed Ice, Cubes, Water
Light	●	●
Door alarm	●	●
Quick Ice™ feature	●	●
Water filter indicator light	●	●
Cabinet shelves	4 Glass	4 Glass
Adjustable	3	3
Spillproof	4	4
Deli pan	Clear	Clear
Vegetable/fruit crispers	2 Adj. Humidity	2 Adj. Humidity
ClearLook™ door bins	4 (3 Adj.)	4 (3 Adj.)
Dairy compartment	●	●
Interior light system	Dual-Level	Dual-Level
Quiet Design	Premium	Premium
NeverClean™ condenser	●	●
ENERGY STAR®	●	●
Freezer Features		
FrostGuard™ technology	●	●
Factory-installed automatic icemaker & bin	●	●
Wire slide-out baskets	2	2
Wire cabinet shelves	4	4
Fixed door bins	3	3
Interior light	Dual	Dual
Exterior		
Color(s) available*	BV	WV, BV
CustomStyle configuration	Trimless	Installed Trim
Door handles	Stainless-look, full-length	Stainless-look, full-length
Door hinge	Hydraulic damper design	Hydraulic damper design
Adjustable rollers	Front	Front
Weights & Dimensions		
Height to top of hinge (in.) A	83-29/32	83-29/32
Case depth with door handle (in.) B	26-29/32	26-29/32
Width (in.) C	42	42
Approx. shipping weight (lbs.)	627	627
Power/Rating	120V, 60Hz, 15Amps	120V, 60Hz, 15Amps
Accessories		
Black acrylic panels	N/A	PSPK42RBB
White acrylic panels	N/A	PSPK42RWW

*Color(s) available: WV = White dispenser and visor handles, BV = Black dispenser and visor handles.

If installed against a wall, allow clearance of 4" on freezer side to remove bin. Clearance required to remove fresh food full size pan without disassembling is 4".

ALL MODELS AVAILABLE IN U.S. AND CANADA.

Built-In Refrigerators

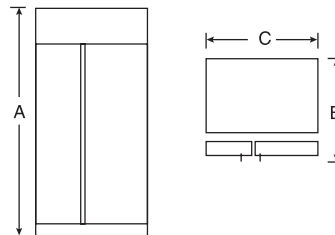

Side-By-Side Refrigerators

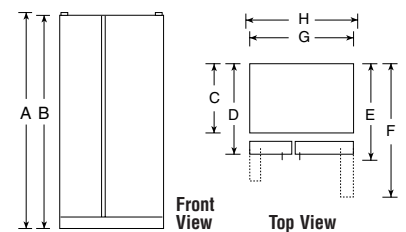

Total volume and shelf area are calculated by the Association of Home Appliance Manufacturers' standards.



Listed by Underwriters Laboratories

GE Profile Arctica® and GE CustomStyle™ Side-by-Side Refrigerators

	GE Profile								GE®	
	PSW23PSR	PZH23PSR PZH23PGR	PSC23SHR PSC23SGR	PSI23SGR	PSC23NHP PSC23NGP	PSI23NGP	PSI23SCR PSI23NCP	PSC23MGP PSI23MGP	GSC23LSR GSC23LGG	GSC21KGR
Stainless steel model	●	● / -	●	●			● / -		● / -	
Capacity										
Total (cu. ft.)	22.6	22.6	22.7 / 22.6	22.6	22.7 / 22.6	22.6	22.6	22.7	22.7	21.4
Fresh food (cu. ft.)	14.38	14.38	14.41 / 14.38	14.38	14.41 / 14.38	14.38	14.38	14.38	14.38	13.62
Freezer (cu. ft.)	8.17	8.17	8.17	8.24	8.24 / 8.17	8.24	8.19	8.26	8.26	7.83
Shelf area (sq. ft.)	19.7	19.7	18.6 / 19.7	19.7	18.6 / 19.7	19.7	20.6	19.0	18.5	18.2
Fresh Food Features										
Refreshment center			● / -		● / -					
ClimateKeeper system	ClimateKeeper2™	ClimateKeeper2	●	●	●	●	●	●		
Dual evaporator	●	●	●	●	●	●	●	●		
Multiflow air system	●	●	●	●	●	●	●	●		
Upfront electronic digital display	●	●	●	●	●	●	●	●		
Upfront electronic touch temp. controls	●	●	●	●	●	●	●	●	●	●
Electronic sensors	●	●	●	●	●	●	●	●	●	●
TurboCool™ setting	●	●	●	●	●	●	●	●	●	●
SmartWater filtration system	Plus	Plus	Plus	Plus	Plus	Plus	Plus	Plus	Plus	Plus
LightTouch! dispenser	Crushed Ice, Cubes, Water	Crushed Ice, Cubes, Water	Crushed Ice, Cubes, Water	Crushed Ice, Cubes, Water	Crushed Ice, Cubes, Water	Crushed Ice, Cubes, Water	Crushed Ice, Cubes, Water	Crushed Ice, Cubes, Water	Crushed Ice, Cubes, Water	Crushed Ice, Cubes, Water
Light	●	●	●	●	●	●	●	●	●	●
Child lock	●	●	●	●	●	●	●	●	●	●
Door alarm	●	●	●	●	●	●	●	●	●	●
Quick Ice feature	●	●	●	●	●	●	●	●	●	●
Water filter indicator light	●	●	●	●	●	●	●	●	●	●
Cabinet shelves	3 Glass	3 Glass	3 Glass	3 Glass	3 Glass	3 Glass	3 Glass	3 Glass	3 Glass	3 Glass
Adjustable	3	3	3	3	3	3	3	3	3	3
Slide-out, spillproof	2	2	2	2	2	2	2	2	2	2
QuickSpace™ shelf	●	●	●	●	●	●	●	●	●	●
Integrated shelf support system	●	●	●	●	●	●	●	●	●	●
Snuggler™ clip(s)		2	2	1 / 2	2	1 / 2	2	2	2	
3-Stack drawer system	●	●	●	●	●	●	●	●	●	●
Delif drawer	Adj. Temp.	Adj. Temp.	Adj. Temp.	Adj. Temp.	Adj. Temp.	Adj. Temp.	Adj. Temp.	Adj. Temp.	Sealed	Sealed
Vegetable/fruit crisper	Adj. Humidity	Adj. Humidity	Adj. Humidity	Adj. Humidity	Adj. Humidity	Adj. Humidity	Adj. Humidity	Adj. Humidity	Adj. Humidity	Adj. Humidity
Sealed drawer	CustomCool™ w/full-extension	CustomCool w/full-extension	CustomCool w/full-extension	CustomCool w/full-extension	CustomCool w/full-extension	CustomCool w/full-extension	CustomCool w/full-extension	Full-extension	●	●
ClearLook door bins	4 (3 Adj.)	4 (3 Adj.)	3 (1 Adj.) 4 (3 Adj.)	4 (3 Adj.)	3 (1 Adj.) 4 (3 Adj.)	4 (3 Adj.)	4 (3 Adj.)	4 (3 Adj.)	4 (3 Adj.)	4 (3 Adj.)
Dairy compartment (removable)	●	●	●	●	●	●	●	●	●	●
Beverage rack	In-the-door	In-the-door	Can storage rack In-the-door	In-the-door	Can storage rack In-the-door	In-the-door	In-the-door	In-the-door		
Interior light system	Tri-level	Tri-level	Tri-level	Tri-level	Tri-level	Tri-level	Tri-level	Dual-level	Dual-level	Dual-level
Quiet Design	Super premium	Super premium	Premium	Premium	Premium	Premium	Premium	Premium	Deluxe	Deluxe
NeverClean condenser	●	●	●	●	●	●	●	●	●	●
ENERGY STAR®	●	●	●	●	●	●	●	●	●	●
Freezer Features										
FrostGuard technology	●	●	●	●	●	●	●	●	●	●
Integrated Ice™ system	●	●	●	●	●	●	●	●	●	●
Wire slide-out baskets	4 (3 full-ext.)	4 (3 full-ext.)	4 (3 full-ext.)	4 (3 full-ext.)	4 (3 full-ext.)	4 (3 full-ext.)	4 (3 full-ext.)	3	3	1
Wire cabinet shelves	2 (1 slide-out)	2 (1 slide-out)	2 (1 slide-out)	2 (1 slide-out)	2 (1 slide-out)	2 (1 slide-out)	2 (1 slide-out)	2 (1 slide-out)	2 (1 slide-out)	2 (1 slide-out)
Wire tilt-out door bin(s)	3 (2 Adj.)	3 (2 Adj.)	3 (2 Adj.)	3 (2 Adj.)	3 (2 Adj.)	3 (2 Adj.)	4 (3 Adj.)	3 (2 Adj.)		
Door shelves									4 (2 Adj.)	3 (2 Adj.)
Interior light	Dual	Dual	Dual	Dual	Dual	Dual	Dual	Dual	Dual	Single
Exterior										
Color(s) available*	SS	SV / WW, CC, BB	SS	SV	WW, CC, BB	WW, CC, BB	SV / WW, CC, BB	WW, CC, BB	SS / WW, BB	WW, BB
CustomStyle configuration	Trimless	Trimless/Install.Trim	Trimless	Trimless	Trimless	Installed Trim	Trimless/Install.Trim	Trimless/Install.Trim	Trimless	Trimless
Door handles*	Sculptured stainless steel	Full-length visor/ CM Full-length visor	Sculptured stainless steel	Full-length visor	CM Profile	CM Full-length visor	Full-length visor/ CM Full-length visor	CM Profile/ CM Full-length visor	Stainless steel/ CM	CM
Exterior design	Full-wrap contoured	Squared doors	Rounded doors	Squared doors	Rounded doors	Squared doors	Squared doors	Rounded doors/ Squared doors	Rounded doors	Rounded doors
Textured steel door and case	Case only	Case only / ●	Case only	Case only	●	Case only	Case only	● / Case only	Case only / ●	●
Adjustable rollers	All	All	All	All	All	All	All	All	Front	Front
Weights & Dimensions										
Height to top of hinge (in.) A	70-1/2†	69-1/4	69-1/4	69-1/4	69-1/4	69-1/4	69-1/4	69-1/4	69-1/4	69-1/4
Height to top of case (in.) B	70-1/2	68-3/4	68-3/4	68-3/4	68-3/4	68-3/4	68-3/4	68-3/4	68-3/4	68-3/4
Height to top of door trim (in.)		70-1/4		70-1/4		70-1/4		- / 70-1/4		
Case depth without door (in.) C	23-7/8	23-7/8	23-7/8	23-7/8	23-7/8	23-7/8	23-7/8	23-7/8	23-7/8	23-7/8
Case depth less door handle (in.) D	31-1/4	31-1/4	26-3/4	26-3/4	26-3/4	26-3/4	26-3/4	26-3/4	26-3/4	26-3/4
Case depth with door handle (in.) E	33-9/16	33-9/16	29-3/16	28-5/16	29-3/16	28-5/16	28-5/16	29-3/16 / 28-5/16	29-3/16	29-3/16
Depth w/fresh food door open 90° (in.) F	50-1/16	50-1/16	45-9/16	45-9/16	45-9/16	45-9/16	45-9/16	45-9/16	45-9/16	45-9/16
Width (in.) G	35-3/4††	35-3/4	35-3/4	35-3/4	35-3/4	35-3/4	35-3/4	35-3/4	35-3/4	35-3/4
Width w/door open 90° w/door handle (in.) H	36-1/4	36-1/4	38-3/16	37-5/16	38-3/16	37-5/16	37-5/16	38-3/16 / 37-5/16	38-3/16	38-3/16
Air clearances										
Each side (in.)	1/8	1/8	1/8	1/8	1/8	1/8	1/8	1/8	1/8	1/8
Top (in.)	1	1	1	1	1	1	1	1	1	1
Back (in.)	1	1	1/2	1/2	1/2	1/2	1/2	1/2	1/2	1/2
Approx. shipping weight (lbs.)	338	338	334	334	334	334	334	334	334	334
Power/Rating	← 120V, 60Hz, 15Amps →									
Accessories										
Factory trim kit attached	N/A	N/A / ●	N/A	N/A	N/A	●	N/A / ●	N/A / ●	N/A	N/A
Black acrylic panels (optional)	N/A	N/A / PSPK23DDB	N/A	N/A	N/A	PSPK23DDB	N/A / PSPK23CBB	N/A / PSPK23DDB	N/A	N/A
White acrylic panels (optional)	N/A	N/A / PSPK23DWW	N/A	N/A	N/A	PSPK23DWW	N/A / PSPK23CWW	N/A / PSPK23DWW	N/A	N/A
Bisque acrylic panels (optional)	N/A	N/A / PSPK23DCC	N/A	N/A	N/A	PSPK23DCC	N/A / PSPK23CCC	N/A / PSPK23DCC	N/A	N/A
Stainless steel panels (optional)	N/A	N/A / PSPK23DSS	N/A	N/A	N/A	PSPK23DSS	N/A	N/A / PSPK23DSS	N/A	N/A
Black collar trim (optional)	N/A	TRMBISBB	N/A	TRMBISBB	N/A	TRMBISBB	TRMBISBB	N/A / TRMBISBB	N/A	N/A
White collar trim (optional)	N/A	TRMBISWW	N/A	TRMBISWW	N/A	TRMBISWW	TRMBISWW	N/A / TRMBISWW	N/A	N/A
Bisque collar trim (optional)	N/A	TRMBISCC	N/A	TRMBISCC	N/A	TRMBISCC	TRMBISCC	N/A / TRMBISCC	N/A	N/A
Stainless steel collar trim (optional)	N/A	TRMBISSS	N/A	TRMBISSS	N/A	TRMBISSS	TRMBISSS	N/A / TRMBISSS	N/A	N/A

*Color(s) available: SV = Stainless steel with visor handles, SS = Stainless steel, WW = White on white, CC = Bisque on bisque, BB = Black on black, CM = Color-Matched.

†When cap is removed: 69-1/4". ††Width including caps: 36-3/16".

‡If installed against a wall, allow clearance of 13-15/16" on freezer side to remove bin. Clearance required to remove fresh food full size pan without disassembling is 18-5/8".

ALL MODELS AVAILABLE IN U.S. AND CANADA.

GE Profile Arctica CustomStyle™ Side-by-Side Installation Information & Specifications

Rough-In Dimensions

Standard, New Construction and Replacement Installation

Installation Tips to Maximize the Built-In Look

- All wall/floor molding should be removed prior to installation.
- Water recess on rear wall recommended to prevent water line damage. 48" minimum length, 1/4"-diameter water line tubing recommended.
- When possible, recess both copper water line and electrical outlet (see local codes).
- Front and rear leveling legs are adjustable for the built-in look (see owner's manual).
- If optional collar trim kit is to be used or anticipated, see collar trim installation on next page for different rough-in dimensions.

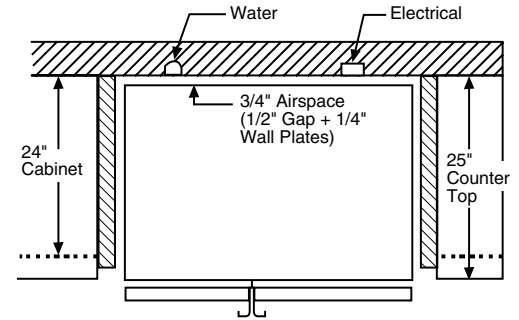
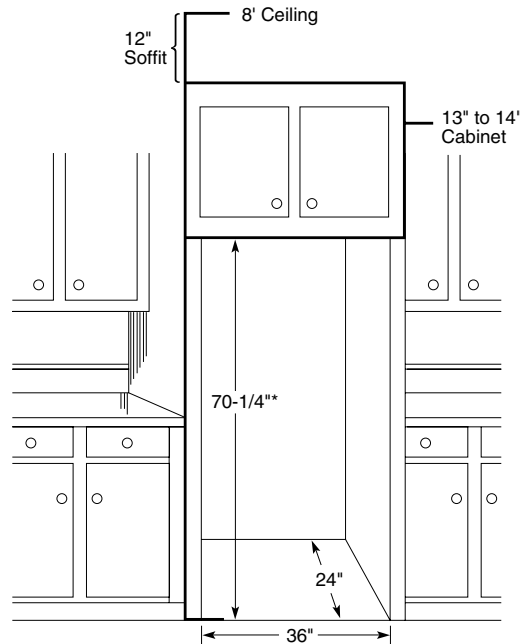

*The rough-in dimension of 70-1/4" is minimum and is measured from the finished floor to top of opening (or the underside of the overhead cabinets). For Models with Trim Kit: If frameless style cabinets are planned for above the refrigerator, you may need to consider adding a maximum of 1/4" (70-1/2") to height of opening to allow additional clearance between cabinet doors and top of refrigerator trim when cabinet doors are in open position.

Installation of Water Outlets

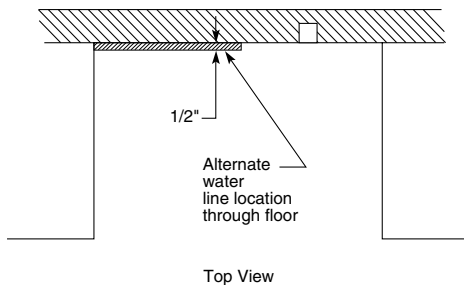

Top View

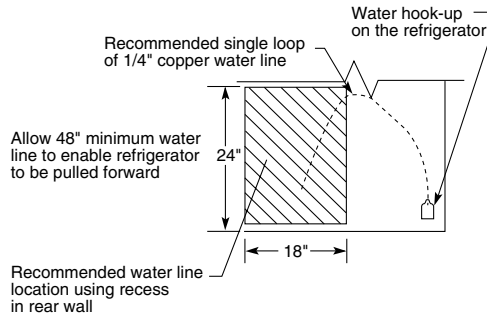

Rear Wall View

IMPORTANT: Before finalizing specifications for your GE Profile CustomStyle Refrigerator, please NOTE:

- A minimum width of 36" is required for refrigerator installation
- Be sure to allow for 1/2" or 3/4" side panels in addition to the 36" minimum

Create a Custom Look for Your GE Profile CustomStyle Side-by-Side Refrigerator

Still another advantage offered by GE Profile CustomStyle Refrigerators is ease of installation. For a refrigerator that does so much to enhance the beauty of your kitchen, the "behind-the-scenes" preparation and installation are surprisingly simple.

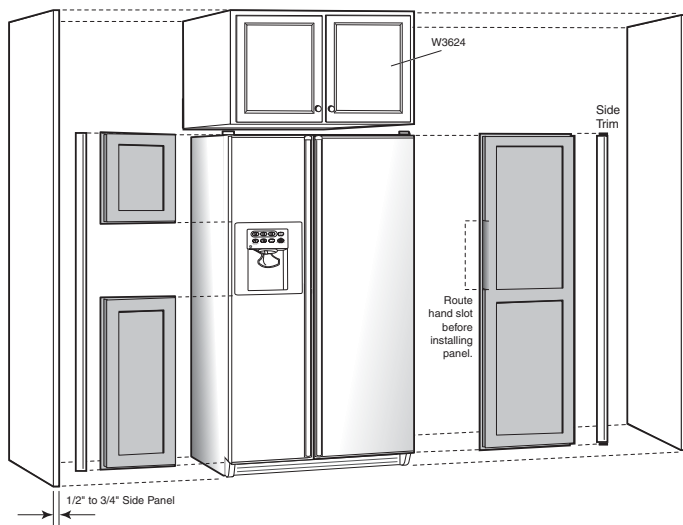

Fabricating the Enclosure

- The drawing shows an 84" cabinet elevation. Adjust dimensions accordingly for other cabinet elevations.
- Cabinet pieces to order: (2) side panels and (1) wall cabinet.
- Side panels will typically be attached to adjacent cabinets and/or cleated to rear wall and floor.
- Refer to GE refrigerator installation instructions for proper plumbing, and electrical and air clearances.
- (1) Some framed cabinet lines will make a refrigerator enclosure with a cabinet 12" high x 39" wide with sides and 1-1/2" face frame extended down to floor to create the refrigerator space. This will replace the above construction.
- (2) A tall cabinet on either side of the refrigerator can replace a side panel.
- Counter overhangs on either side of the refrigerator should have clipped corners to allow for full door swing.
- If the refrigerator has a wall returning beyond the front of the refrigerator on either side, a 2" tall filler will help allow for movement of the door.

Door Panels

- See drawings for exact dimensions of the fresh-food and freezer door panels.
- Refrigerator door fronts from stock and most semi-custom cabinet manufacturers will be supplied as 1/4"-thick panels cut to dimensions, with closest available standard door sizes applied to front.
 - This will leave a "reveal" at top/bottom and sides. Width of "reveal" will depend on manufacturer's standard door sizes.
 - Door will be affixed on the 1/4" panels at factory or in the field by the local supplier, depending on manufacturer.
- Local shop-built or custom cabinet supplier may fabricate custom 3/4" panels. In this case, edges must be routed.
- Follow notes on drawing to assure room for fingers/hands to open handles.

Door Panel Dimensions

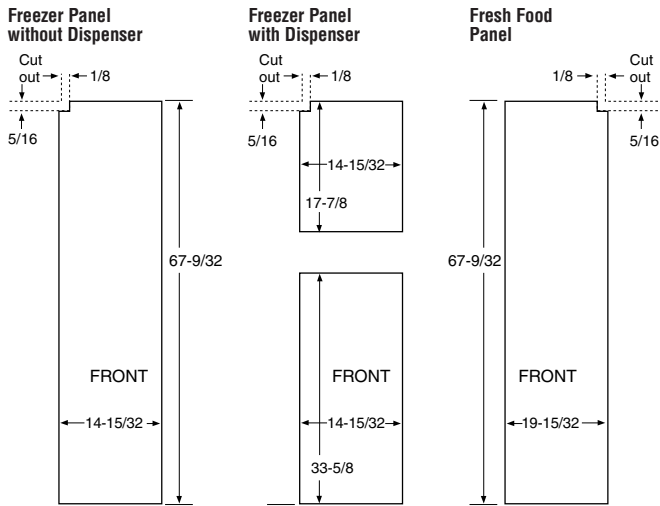

Order your own custom wood panels to match cabinetry or other decor. Panels up to 1/4" thick will fit door frame with no special preparation. Add filler behind material thinner than 1/4" for proper fit.

Weight Limits: Total weight of panels (i.e., both freezer panels)— Fresh Food = 38 lbs., Freezer = 28 lbs.

Note: Panels up to 3/4" will require special routing area around handles. Dimensions may vary depending on depth of panel.

Detail C

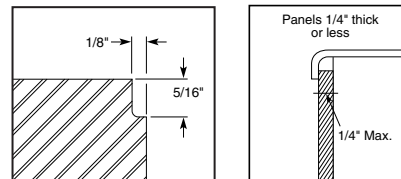

(Fresh Food panel shown)
Notch required at top corner as noted.

Collar Trim Installation

An enclosure is **required** to match up to the trim (see Typical Installation). To obtain the most integrated look, the cabinet or soffit above the refrigerator should extend out to the same depth as the side panels. The refrigerator opening must have minimum dimensions of 70-1/4" high x 36-1/8" wide x 24-1/2" deep as shown at right. If there is an overhead cabinet, allow 1" for cabinet door clearance with the top trim piece so the cabinet doors can be opened without hitting the top trim. If 1/2" side panels are used, then side trim and panel will be even. If 3/4" side panels are used, then some of the side panel will extend beyond the trim and must be finished.

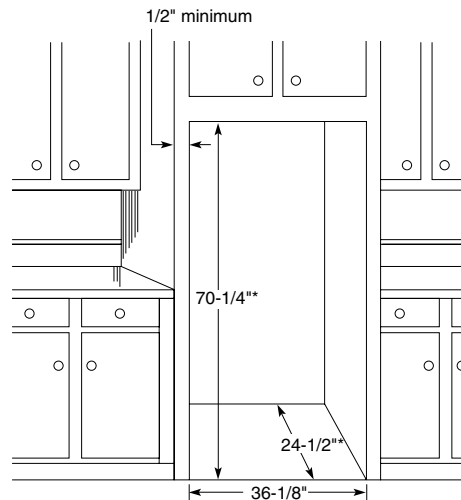

*The rough-in dimension of 70-1/4" is minimum and is measured from the finished floor to top of opening (or the underside of the overhead cabinets). For Models with Trim Kit: If frameless style cabinets are planned for above the refrigerator, you may need to consider adding a maximum of 1/4" (70-1/2") to height of opening to allow additional clearance between cabinet doors and top of refrigerator trim when cabinet doors are in open position.

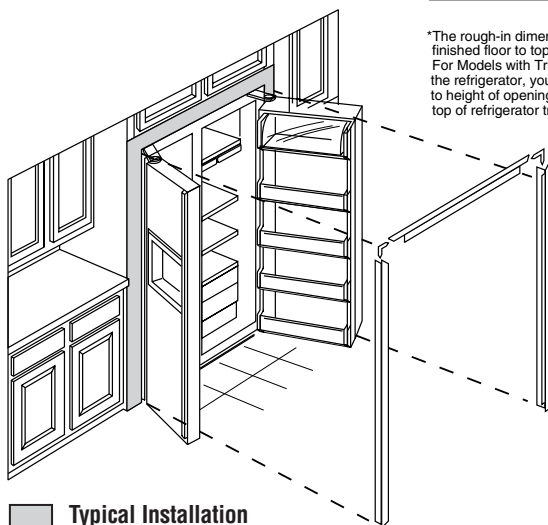
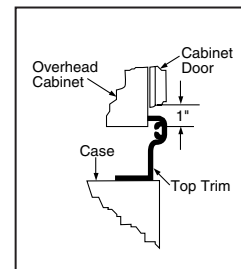
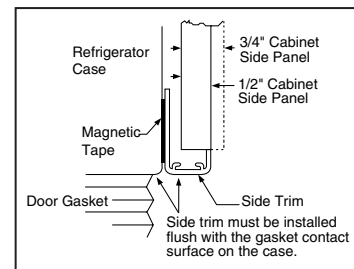

Typical Installation

Shaded areas represent front surfaces of side panels and overhead cabinet or soffit that contacts trim.

IMPORTANT: Before finalizing specifications for your GE Profile CustomStyle Refrigerator, please NOTE:

- A minimum width of 36-1/8" is required for refrigerator installation with collar
- Be sure to allow for 1/2" or 3/4" side panels in addition to the 36-1/8" minimum

GE Profile Arctica® Side-by-Side Refrigerators

	GE Profile™								
	PSS29NHP	PSS29NGP	PSS27SGR	PSS27NGP	PSS26SHR	PSW26SGR	PSS26NHP	PSF26NGP	
Stainless steel model			●		●	●			
Capacity									
Total (cu. ft.)	28.7	28.6	26.5	26.5	25.5	25.5	25.5	25.5	25.5
Fresh food (cu. ft.)	17.92	17.85	16.60	16.60	16.02	16.02	16.02	16.02	16.02
Freezer (cu. ft.)	10.68	10.68	9.92	9.92	9.48	9.48	9.48	9.48	9.48
Shelf area (sq. ft.)	24.0	25.0	23.8	23.8	22.8	23.6	22.8	23.6	
Fresh Food Features									
Refreshment center	●				●		●		
ClimateKeeper™ system	●	●	●	●	●	●	●	●	●
Multiflow air system	●	●	●	●	●	●	●	●	●
Upfront electronic digital display	●	●	●	●	●	●	●	●	●
Upfront electronic touch temp. controls	●	●	●	●	●	●	●	●	●
Electronic sensors	●	●	●	●	●	●	●	●	●
TurboCool™ setting	●	●	●	●	●	●	●	●	●
SmartWater™ filtration system	Plus	Plus	Plus	Plus	Plus	Plus	Plus	Plus	Plus
LightTouch! dispenser	Crushed Ice, Cubes, Water	Crushed Ice, Cubes, Water	Crushed Ice, Cubes, Water	Crushed Ice, Cubes, Water	Crushed Ice, Cubes, Water	Crushed Ice, Cubes, Water	Crushed Ice, Cubes, Water	Crushed Ice, Cubes, Water	Crushed Ice, Cubes, Water
Light	●	●	●	●	●	●	●	●	●
Child lock	●	●	●	●	●	●	●	●	●
Door alarm	●	●	●	●	●	●	●	●	●
Quick Ice™ feature	●	●	●	●	●	●	●	●	●
Water filter indicator light	●	●	●	●	●	●	●	●	●
Cabinet shelves	3 Glass	3 Glass	3 Glass	3 Glass	3 Glass	3 Glass	3 Glass	3 Glass	3 Glass
Adjustable	3	3	3	3	3	3	3	3	3
Slide-out, spillproof	2	2	2	2	2	2	2	2	2
QuickSpace™ shelf	●	●	●	●	●	●	●	●	●
Integrated shelf support system	●	●	●	●	●	●	●	●	●
Snugger™ clip(s)	2	2	2	2	2	2	2	2	2
3-Stack drawer system	●	●	●	●	●	●	●	●	●
Deli drawer	Adj. Temp.	Adj. Temp.	Adj. Temp.	Adj. Temp.	Adj. Temp.	Adj. Temp.	Adj. Temp.	Adj. Temp.	Adj. Temp.
Vegetable/fruit crisper	Adj. Humidity	Adj. Humidity	Adj. Humidity	Adj. Humidity	Adj. Humidity	Adj. Humidity	Adj. Humidity	Adj. Humidity	Adj. Humidity
Sealed drawer	CustomCool™ w/full-extension	CustomCool™ w/full-extension	CustomCool™ w/full-extension	CustomCool™ w/full-extension	CustomCool™ w/full-extension	CustomCool™ w/full-extension	CustomCool™ w/full-extension	CustomCool™ w/full-extension	CustomCool™ w/full-extension
ClearLook™ door bins	3 (1 Adj.)	4 (3 Adj.)	4 (3 Adj.)	4 (3 Adj.)	3 (1 Adj.)	4 (3 Adj.)	3 (1 Adj.)	4 (3 Adj.)	4 (3 Adj.)
Dairy compartment (removable)	●	●	●	●	●	●	●	●	●
Beverage rack	Can storage rack	In-the-door	In-the-door	In-the-door	Can storage rack	In-the-door	Can storage rack	In-the-door	
Interior light system	Tri-level	Tri-level	Tri-level	Tri-level	Tri-level	Tri-level	Tri-level	Tri-level	Tri-level
Quiet Design	Premium	Premium	Premium	Premium	Premium	Premium	Premium	Premium	Premium
NeverClean™ condenser	●	●	●	●	●	●	●	●	●
2004 ENERGY STAR®					●	●	●	●	●
Freezer Features									
FrostGuard™ technology	●	●	●	●	●	●	●	●	●
Integrated Ice™ system	●	●	●	●	●	●	●	●	●
Wire slide-out baskets	4 (3 full-ext.)	4 (3 full-ext.)	4 (3 full-ext.)	4 (3 full-ext.)	4 (3 full-ext.)	4 (3 full-ext.)	4 (3 full-ext.)	4 (3 full-ext.)	4 (3 full-ext.)
Wire cabinet shelves	2	2	2	2	2	2	2	2	2
Wire tilt-out door bin(s)	3 (2 Adj.)	3 (2 Adj.)	3 (2 Adj.)	3 (2 Adj.)	3 (2 Adj.)	3 (2 Adj.)	3 (2 Adj.)	3 (2 Adj.)	3 (2 Adj.)
Door shelves	1	1	1	1	1	1	1	1	1
Interior light	Dual	Dual	Dual	Dual	Dual	Dual	Dual	Dual	Dual
Exterior									
Color(s) available*	WW, CC, BB	WW, CC, BB	SS	WW, CC, BB	SS	SS	WW, CC, BB	WW, CC, BB	WW, CC, BB
Door handle(s)	Color-Matched Contoured Profile	Color-Matched Contoured Profile	Sculptured Stainless steel	Color-Matched Contoured Profile	Sculptured Stainless steel	Sculptured Stainless steel	Color-Matched Contoured Profile	Color-Matched Contoured Profile	Color-Matched Contoured Profile
Exterior design	Contoured	Contoured	Contoured	Contoured	Contoured	Full-Wrap Contoured	Contoured	High-Gloss	
Textured steel door and case	●	●	Case only	●	Case only	●	●	Case only	
Adjustable rollers	Front	Front	Front	Front	Front	Front	Front	Front	Front
Weights & Dimensions									
Height to top of hinge (in.) A	69-1/4	69-1/4	69-1/4	69-1/4	69-1/4	70-1/2††	69-1/4	69-1/4	69-1/4
Height to top of case (in.) B	68-3/4	68-3/4	68-3/4	68-3/4	68-3/4	70-1/2	68-3/4	68-3/4	68-3/4
Case depth without door(in.) C †	28	28	28	28	28	28-1/2	28	28	28
Case depth less door handle (in.) D †	33-9/16	33-9/16	32-1/4	32-1/4	32-1/4	32-3/4	32-1/4	32-1/4	32-1/4
Case depth with door handle (in.) E †	36	36	34-11/16	34-11/16	34-11/16	35-3/16	34-11/16	34-11/16	34-11/16
Depth w/fresh food door open 90°(in.) F †	49-11/16	49-11/16	50-1/16	50-1/16	50-1/16	50-9/16	50-1/16	50-1/16	50-1/16
Width (in.) G	35-3/4	35-3/4	35-3/4	35-3/4	35-3/4	35-7/8**	35-3/4	35-3/4	35-3/4
Width w/door open 90° w/door handle (in.) H	39	39	36-1/4	36-1/4	36-1/4	36-1/4	36-1/4	36-1/4	36-1/4
Air clearances Each side (in.)	1/8	1/8	1/8	1/8	1/8	1/8	1/8	1/8	1/8
Top (in.)	1	1	1	1	1	1	1	1	1
Back (in.)	1	1	1	1	1	1	1	1	1
Approx. shipping weight (lbs.)	320	320	346	346	346	393	346	365	
Power/Rating	120V, 60Hz, 15Amps								

*Color(s) available: SS = Stainless steel, WW = White on white, CC = Bisque on bisque, BB = Black on black.

**Width including caps is 36-3/16".

†Water hook-up fits in back air clearance when calculating installation depth.

††When cap is removed: 69-1/4".

If installed against a wall, allow clearance of 14-3/16" on 25 cu. ft., 26 cu. ft. and 27 cu. ft. models; 13" on 29 cu. ft. models on freezer side to remove ice bin. To remove fresh food pans, remove door bins. Clearances required to remove fresh food full-size pan without disassembling: 18-15/16" on 25 cu. ft., 26 cu. ft. and 27 cu. ft.; 16-1/4" on 29 cu. ft. Allow additional space for any necessary leveling adjustments.

ALL MODELS AVAILABLE IN U.S. AND CANADA.
Energy information available at www.GEAppliances.com

	PSS26SGR	PSS26NGP	PSS26MSR	PSS26MGP	PSS26LSR	PSS26LGR
	●		●		●	
	25.5	25.5	25.5	25.5	25.6	25.6
	16.02	16.02	16.02	16.02	16.02	16.02
	9.48	9.48	9.48	9.48	9.6	9.6
	23.6	23.6	23.7	23.7	23.8	23.8
	●	●	●	●		
	●	●	●	●		
	●	●	●	●		
	●	●	●	●	●	●
	●	●	●	●	●	●
	●	●	●	●	●	●
	Plus	Plus	Plus	Plus	Plus	Plus
	Crushed Ice, Cubes, Water	Crushed Ice, Cubes, Water	Crushed Ice, Cubes, Water	Crushed Ice, Cubes, Water	Crushed Ice, Cubes, Water	Crushed Ice, Cubes, Water
	●	●	●	●	●	●
	●	●	●	●	●	●
	●	●	●	●	●	●
	●	●	●	●	●	●
	●	●	●	●	●	●
	3 Glass	3 Glass	3 Glass	3 Glass	3 Glass	3 Glass
	3	3	3	3	3	3
	2	2	2	2	2	2
	●	●	●	●	●	●
	●	●	●	●	●	●
	2	2	2	2		
	●	●	●	●	●	●
	●	●	●	●	●	●
	Adj. Temp.	Adj. Temp.	Adj. Temp.	Adj. Temp.	●	●
	Adj. Humidity	Adj. Humidity	Adj. Humidity	Adj. Humidity	Adj. Humidity	Adj. Humidity
	CustomCool w/full-extension	CustomCool w/full-extension	Full-extension	Full-extension	●	●
	4 (3 Adj.)	4 (3 Adj.)	4 (3 Adj.)	4 (3 Adj.)	4 (3 Adj.)	4 (3 Adj.)
	●	●	●	●	●	●
	In-the-door	In-the-door	In-the-door	In-the-door	Wine rack	Wine rack
	Tri-level	Tri-level	Dual-level	Dual-level	Dual-level	Dual-level
	Premium	Premium	Premium	Premium	Premium	Premium
	●	●	●	●	●	●
	●	●	●	●	●	●
	●	●	●	●	●	●
	4 (3 full-ext.)	4 (3 full-ext.)	3 full-ext.	3 full-ext.	3-1/2	3-1/2
	2	2	2	2	2	2
	3 (2 Adj.)	3 (2 Adj.)	3 (2 Adj.)	3 (2 Adj.)		
	1	1	1	1	4 (2 Adj.)	4 (2 Adj.)
	Dual	Dual	Dual	Dual	Dual	Dual
	SS	WW, CC, BB	SS	WW, CC, BB	SS	WW, CC, BB
	Sculptured Stainless steel	Color-Matched Contoured Profile	Sculptured Stainless steel	Color-Matched Contoured Profile	Sculptured Stainless steel	Color-Matched Contoured Profile
	Contoured	Contoured	Contoured	Contoured	Contoured	Contoured
	Case only	●	Case only	●	Case only	●
	Front	Front	Front	Front	Front	Front
	69-1/4	69-1/4	69-1/4	69-1/4	69-1/4	69-1/4
	68-3/4	68-3/4	68-3/4	68-3/4	68-3/4	68-3/4
	28	28	28	28	28	28
	32-1/4	32-1/4	32-1/4	32-1/4	31-1/4	31-1/4
	34-11/16	34-11/16	34-11/16	34-11/16	33-9/16	33-9/16
	50-1/16	50-1/16	50-1/16	50-1/16	50-1/16	50-1/16
	35-3/4	35-3/4	35-3/4	35-3/4	35-3/4	35-3/4
	36-1/4	36-1/4	36-1/4	36-1/4	36-1/4	36-1/4
	1/8	1/8	1/8	1/8	1/8	1/8
	1	1	1	1	1	1
	1	1	1	1	1	1
	347	347		347	338	338
← 120V, 60Hz, 15Amps →						

Side-by-Side Refrigerators

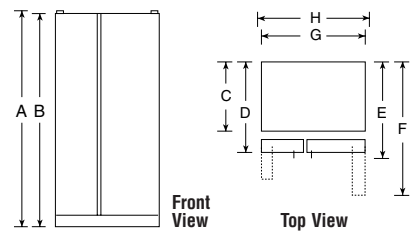

Total volume and shelf area are calculated by the Association of Home Appliance Manufacturers' standards.



Listed by Underwriters Laboratories

GE® Side-by-Side Refrigerators

	GE "K" Series				GE "J" Series		
	GSH25SGR GSH22SGR	GSS25SGR GSS22SGR	GSS25KGP GSS22KGP	GSH25KGR GSH22KGR	GSL25JFP GSL22JFP	GSS25JFP GSS22JFP	GSS25JEP GSS22JEP
Stainless steel model	●	●					
Capacity							
Total (cu. ft.)	25.0 / 21.9	25.0 / 21.9	25.0 / 21.9	25.0 / 21.9	25.0 / 22.0	25.0 / 22.0	25.0 / 22.0
Fresh food (cu. ft.)	15.40 / 14.77	15.40 / 14.77	15.40 / 14.77	15.40 / 14.77	15.40 / 14.84	15.40 / 14.84	15.40 / 14.84
Freezer (cu. ft.)	9.56 / 7.14	9.56 / 7.14	9.56 / 7.14	9.56 / 7.14	9.56 / 7.14	9.56 / 7.14	9.56 / 7.14
Shelf area (sq. ft.)	24.3 / 22.4	24.3 / 22.4	24.3 / 22.4	24.3 / 22.4	22.3 / 20.3	22.3 / 20.3	22.3 / 20.3
Fresh Food Features							
SmartWater™ filtration system	Plus	Plus	Plus	Plus	●	●	
	Crushed Ice, Cubes, Water	Crushed Ice, Cubes, Water	Crushed Ice, Cubes, Water	Crushed Ice, Cubes, Water	Crushed Ice, Cubes, Water	Crushed Ice, Cubes, Water	Crushed Ice, Cubes, Water
LightTouch! dispenser features							
Light	●	●	●	●	●	●	●
Child lock	●	●	●	●			
Water filter indicator light	●	●	●	●			
Upfront electronic touch temperature controls	●	●	●	●			
Upfront electronic temperature controls	●	●	●	●	●	●	●
Cabinet shelves	3 Glass	3 Glass	3 Glass	3 Glass	3 Glass	3 Glass	3 Glass
Adjustable	3	3	3	3	3	3	3
Slide-out	3	3	3	3			
Spillproof	3	3	3	3	3	3	3
Snugger™ clip	1	1	1	1			
2-Stack drawer system	●	●	●	●	●	●	●
Deli drawer	1 Adj. Temp.	1 Adj. Temp.	1 Adj. Temp.	1 Adj. Temp.	1 Adj. Temp.	1 Adj. Temp.	1 Adj. Temp.
Vegetable/fruit crisper	1 Adj. Humidity	1 Adj. Humidity	1 Adj. Humidity	1 Adj. Humidity	1 Sealed	1 Sealed	1 Sealed
Snack pan	●	●	●	●			
Adjustable door bins	4 (2 Adj. w/ gallon storage)	4 (2 Adj. w/ gallon storage)	4 (2 Adj. w/ gallon storage)	4 (2 Adj. w/ gallon storage)	4 (2 Adj. w/ gallon storage)	4 (2 Adj. w/ gallon storage)	4 (2 Adj. w/ gallon storage)
Dairy compartment	●	●	●	●	●	●	●
Interior light system	Dual-level	Dual-level	Dual-level	Dual-level	Dual-level	Dual-level	Single-level
Quiet Design	Deluxe	Deluxe	Deluxe	Deluxe	Deluxe	Deluxe	Deluxe
NeverClean™ condenser	●	●	●	●	●	●	●
ENERGY STAR®	●			●			
Freezer Features							
Factory-installed icemaker and bin	●	●	●	●	●	●	●
FrostGuard™ technology	●	●	●	●	●	●	●
Wire cabinet shelves	4 (3 Adj.)	4 (3 Adj.)	4 (3 Adj.)	4 (3 Adj.)	4 (3 Adj.)	4 (3 Adj.)	4 (3 Adj.)
Storage basket(s)	1 slide-out	1 slide-out	1 slide-out	1 slide-out	1 bin	1 bin	1 bin
Door shelves	5	5	5	5	5	5	5
Interior light	●	●	●	●	●	●	●
Appearance							
Color(s) available*	SS	SS	WW, CC, BB	WW, CC, BB	CleanSteel™	WW, CC, BB	WW, CC, BB
Deluxe door handle(s)*	Stainless Steel	Stainless Steel	CM Premium	CM Premium	Black	CM Premium	CM Premium
Textured steel door and case	Case only	Case only	●	●	Case only	●	●
Adjustable rollers	Front	Front	Front	Front	Front	Front	Front
Weights & Dimensions							
Height to top of hinge (in.) A	69-3/4 / 67-1/2	69-3/4 / 67-1/2	69-3/4 / 67-1/2	69-3/4 / 67-1/2	69-3/4 / 67-1/2	69-3/4 / 67-1/2	69-3/4 / 67-1/2
Height to top of case (in.) B	68-3/4 / 66-1/2	68-3/4 / 66-1/2	68-3/4 / 66-1/2	68-3/4 / 66-1/2	68-3/4 / 66-1/2	68-3/4 / 66-1/2	68-3/4 / 66-1/2
Case depth without door (in.) C†	28	28	28	28	28	28	28
Case depth less door handle (in.) D†	31-1/4	31-1/4	31-1/4	31-1/4	31-1/4	31-3/4	31-1/4
Case depth with door handle (in.) E†	33-9/16	33-9/16	33-9/16	33-9/16	33-9/16	33-9/16	33-9/16
Depth with fresh food door open 90° (in.) F†	49-3/8	49-3/8	49-3/8	49-3/8	49-3/8	49-3/8	49-3/8
Width (in.) G	35-3/4 / 33-1/2	35-3/4 / 33-1/2	35-3/4 / 33-1/2	35-3/4 / 33-1/2	35-3/4 / 33-1/2	35-3/4 / 33-1/2	35-3/4 / 33-1/2
Width w/door open 90° w/door handle (in.) H	38-3/16 / 35-15/16	38-3/16 / 35-15/16	38-3/16 / 35-15/16	38-3/16 / 35-15/16	38-3/16 / 35-15/16	38-3/16 / 35-15/16	38-3/16 / 35-15/16
Air clearances Each side (in.)	1/8	1/8	1/8	1/8	1/8	1/8	1/8
Top (in.)	1	1	1	1	1	1	1
Back (in.)	1	1	1	1	1	1	1
Approx. shipping weight (lbs.)	338 / 334	338 / 334	338 / 334	338 / 334	338 / 315	338 / 315	338 / 321
Power/Ratings	120V, 60Hz, 15Amps						

*Color(s) available: SS = Stainless steel, WW = White on white, CC = Bisque on bisque, BB= Black on black, CM = Color-Matched, CleanSteel = Stainless appearance.

†Water hook-up fits in back air clearance when calculating installation depth.

If installed against a wall, allow clearance of 10-3/4" on 20 cu. ft. and 22 cu. ft. models; 14-3/16" on 25 cu. ft. models on freezer side to remove bin.

Clearances required to remove fresh food full-size pan without disassembling: 13-1/2" on 20 cu. ft.; 15" on 22 cu. ft.; and 18-15/16" on 25 cu. ft.

Allow additional space for any necessary leveling adjustments.

ALL MODELS AVAILABLE IN U.S. AND CANADA.

Side-By-Side Refrigerators

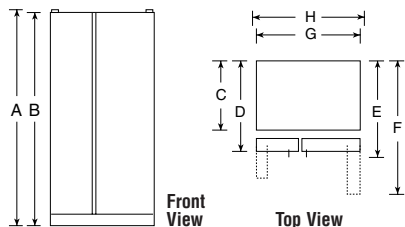

Total volume and shelf area are calculated by the Association of Home Appliance Manufacturers' standards.



Listed by Underwriters Laboratories

	GE "I" Series			GE "D" Series
	GSS25IFP GSS22IFP	GSS20IEP	GSS22IBP GSS20IBP	GSS20DBP
Capacity				
Total (cu. ft.)	25.0 / 22.0	20.0	21.9 / 19.9	19.9
Fresh food (cu. ft.)	15.48 / 14.84	12.87	14.87 / 12.87	12.87
Freezer (cu. ft.)	9.56 / 7.14	7.14	7.04	7.04
Shelf area (sq. ft.)	22.3 / 20.3	17.3	21.1 / 18.0	18.1
Fresh Food Features				
SmartWater filtration system	●			
LightTouch! dispenser features	Crushed Ice, Cubes, Water	Crushed Ice, Cubes, Water		
Light	●	●		
Upfront electronic temperature controls	●	●	●	●
Cabinet shelves	3 glass	3 glass	3 glass	3 wire Everwhite
Adjustable	3	3	3	3
Meat drawer	1 sealed	1 sealed	1 sealed	1 sealed opaque
Vegetable/fruit crisper	1 sealed	1 sealed	1 sealed	1 sealed opaque
Door bins	4 (2 adj. w/ gallon storage)	4 (2 w/ gallon storage)	4 (2 w/ gallon storage)	4 (2 w/ gallon storage)
Dairy compartment	●	●	●	●
Interior light system	Single-level	Single-level	Single-level	Single-level
Quiet Design	Deluxe	Deluxe	Deluxe	Deluxe
NeverClean condenser	●	●	●	●
Freezer Features				
Factory-installed icemaker and bin	●	●	Opt. (IM5SS)	Opt. (IM5SS)
FrostGuard technology	●	●	●	●
Wire cabinet shelves	3 (2 adj.)	3 (2 adj.)	5 (4 adj.) 4 (3 adj.)	4 (3 adj.)
Storage basket(s)	1 bin	1 bin	1 bin	1 bin
Door shelves	5	5	6	6
Interior light	●	●	●	●
Appearance				
Color(s) available*	WW, CC, BB	WW, CC, BB	WW, CC	WW, CC
Deluxe door handle(s)*	CM	CM	CM	CM
Textured steel door and case	●	●	●	●
Adjustable rollers	Front	Front	Front	Front
Weights & Dimensions				
Height to top of hinge (in.) A	69-3/4 / 67-1/2	67-1/2	67-1/2	67-1/2
Height to top of case (in.) B	68-3/4 / 66-1/2	66-1/2	66-1/2	66-1/2
Case depth without door (in.) C†	28	28	28	28
Case depth less door handle (in.) D†	31-1/4	31-1/4	31-1/4	31-1/4
Case depth with door handle (in.) E†	33-9/16	33-9/16	33-9/16	33-9/16
Depth with fresh food door open 90° (in.) F†	49-3/8	47-3/8	49-3/8 / 47-3/8	47-3/8
Width (in.) G	35-3/4 / 33-1/2	31-1/2	33-1/2 / 31-1/2	31-1/2
Width w/door open 90° w/door handle (in.) H	38-3/16 / 35-15/16	33-15/16	35-15/16 / 33-15/16	33-15/16
Air clearances Each side (in.)	1/8	1/8	1/8	1/8
Top (in.)	1	1	1	1
Back (in.)	1	1	1	1
Approx. shipping weight (lbs.)	344 / 321	306	321 / 306	306
Power/Ratings	← 120V, 60 Hz, 15Amps →			

*Color(s) available: WW = White on white, CC = Bisque on bisque, BB= Black on black, CM = Color-Matched.

†Water hook-up fits in back air clearance when calculating installation depth.

If installed against a wall, allow clearance of 10-3/4" on 20 cu. ft. and 22 cu. ft. models;

14-3/16" on 25 cu. ft. models on freezer side to remove bin.

Clearances required to remove fresh food full-size pan without disassembling:

13-1/2" on 20 cu. ft.; 15" on 22 cu. ft.; and 18-15/16" on 25 cu. ft.

Allow additional space for any necessary leveling adjustments.

ALL MODELS AVAILABLE IN U.S. AND CANADA.

Side-By-Side Refrigerators

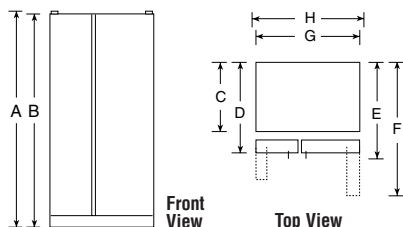

Total volume and shelf area are calculated by the Association of Home Appliance Manufacturers' standards.



Listed by Underwriters Laboratories

GE Profile™ and GE® Bottom-Freezer Refrigerators

	GE Profile							GE	
	PDW22SHR PDW22SCR	PDF22MCR	PDS22SHR PDS22SBR	PDS22MHR PDS22MBR	PDS22SCR PDS22MCR	PDS20SCR PDS20SBR	PDS20MCR PDS20MBR	GBS22KBR GBS20KBR	GBS22HCR GBS22HBR
Stainless steel model	●		●		● / -	●			
Capacity									
Total (cu. ft.)	22.2	22.2	22.2	22.2	22.2	19.5	19.5	22.3 / 19.5	22.3
Fresh food (cu. ft.)	15.21	15.21	15.21	15.21	15.21	13.21	13.21	15.21 / 13.21	15.22
Freezer (cu. ft.)	7.04	7.04	7.04	7.04	7.04	6.31	6.31	7.05 / 6.32	7.09
Shelf area (sq. ft.)	27.66	27.66	27.66	27.66	27.66	24.44	24.44	23.99 / 21.43	24.27
Fresh Food Features									
Cabinet shelves	4 Glass	4 Glass	4 Glass	4 Glass	4 Glass	4 Glass	4 Glass	4 Glass	3 Glass
Adjustable	4 Split	4 Split	4 Split	4 Split	4 Split	4 Split	4 Split	4 Split	2 Split, 1 F/W
Slide-out	2	2	2	2	2	2	2		
Spillproof	4	4	4	4	4	4	4	4	
QuickSpace shelf	●	●	●	●	●	●	●		
Internal water dispenser	● / -		● / -	● / -					
GE SmartWater™ filtration	●	●	● / -	● / -	●	● / -	● / -		
ShelfSaver™ rack	●	●	●	●	●	●	●		
Vegetable/fruit crisper(s)	2 Adj. Humidity	2 Adj. Humidity	2 Adj. Humidity	2 Adj. Humidity	2 Adj. Humidity	2 Adj. Humidity	2 Adj. Humidity	2 Adj. Humidity	2 Clear
Deli drawer	Adj. Humidity	Adj. Humidity	Adj. Humidity	Adj. Humidity	Adj. Humidity	Adj. Humidity	Adj. Humidity	Clear	Clear
Pivot-out pan removal system	●	●	●	●	●	●	●	●	●
ClearLook™ adjustable gallon door bins	4	4	4	4	4	4	4	4 opaque	
Snugger™ clip	●	●	●	●	●	●	●		
Fixed door bins	1 F/W w/ gallon storage	1 F/W w/ gallon storage	1 F/W w/ gallon storage	1 F/W w/ gallon storage	1 F/W w/ gallon storage	1 F/W w/ gallon storage	1 F/W w/ gallon storage	1 F/W w/ gallon storage	2 F/W w/ gallon storage
Dairy compartment	●	●	●	●	●	●	●	●	●
Interior light (GE Reveal™)	Dual	Dual	Dual	Dual	Dual	Dual	Dual	Dual	Dual
Quiet Design	Deluxe	Deluxe	Deluxe	Deluxe	Deluxe	Deluxe	Deluxe	Deluxe	Deluxe
NeverClean™ condenser	●	●	●	●	●	●	●	●	●
2004 ENERGY STAR®	●	●	●	●	●	●	●	●	●
Freezer Features									
Factory-installed icemaker & bin	Integrated	Integrated	Integrated Opt. (IM4A)	Integrated Opt. (IM4A)	Integrated	Integrated Opt. (IM4A)	Integrated Opt. (IM4A)	Opt. (IM4A)	Opt. (IM4A)
Ice 'N Easy trays			- / 2	- / 2		- / 2	- / 2	2	- / 2
Full slide-out wire basket(s)	2 F/W, 1 Split	2 F/W, 1 Split	2 F/W, 1 Split	2 F/W, 1 Split	2 F/W, 1 Split	2 F/W, 1 Split	2 F/W, 1 Split	1 F/W, 1 Split	1 F/W
Wire compartment shelves									1 F/W
Door shelves								1 Split	1 Split
Interior light (GE Reveal)	●	●	●	●	●	●	●	●	●
Exterior									
Color(s) available*	SS	WW, BB	SS	WW, CC, BB	SS / WW, CC, BB	SS	WW, CC, BB	WW, CC, BB	WW, CC, BB
Door handle(s)	Sculptured	Color-Matched	Sculptured	Color-Matched	Sculptured Color-Matched	Sculptured	Color-Matched	Color-Matched	Color-Matched
Customer installed handles		●	●	●	●	●	●	●	●
Exterior design	Full-wrap contoured	Contoured High-Gloss	Contoured Doors	Contoured Doors	Contoured Doors	Contoured Doors	Contoured Doors	Contoured Doors	Contoured Doors
Door stops	●	●	●	●	●	●	●	●	●
Reversible doors		●			- / ●		●	●	●
Choose left or right door opening	Right only		●		● / -	●			
Adjustable rollers	Front	Front	Front	Front	Front	Front	Front	Front	Front
Weights & Dimensions									
Height to top of hinge (in.) A	68-5/8	68-5/8	68-5/8	68-5/8	68-5/8	68	68	68-5/8 / 68	68-5/8
Height to top of case (in.) B	70	67-7/8	67-7/8	67-7/8	67-7/8	67-1/4	67-1/4	67-7/8 / 67-1/4	67-7/8
Case depth without door (in.) C	28-1/2	28-1/4	28-1/4	28-1/4	28-1/4	28-1/4	28-1/4	28-1/4	28-1/4
Case depth less door handle (in.) D	32	31-3/4	31-3/4	31-3/4	31-3/4	31-3/4	31-3/4	31-3/4	31-3/4
Case depth with door handle (in.) E	34-1/4	33-7/8	33-7/8	33-7/8	33-7/8	33-7/8	33-7/8	34-1/8	34-1/8
Depth w/fresh food door open 90° (in.) F	59-1/4	62	62	62	62	59	59	62 / 59	62
Width (in.) G	33	32-7/8	32-7/8	32-7/8	32-7/8	29-7/8	29-7/8	32-7/8 / 29-7/8	32-7/8
Width with door open 90° w/door handle (in.) H	36-3/4	36-1/4	36-1/4	36-1/4	36-1/4	33-1/4	33-1/4	36-1/2 / 33-1/2	36-1/2
Air clearances Each side (in.)	1/8	1/8	1/8	1/8	1/8	1/8	1/8	1/8	1/8
Top (in.)	1	1	1	1	1	1	1	1	1
Back (in.)	1	1	1	1	1	1	1	1	1
Approx. shipping weight (lbs.)	337	287	287	287	287	265	265	287 / 265	287
Power/Ratings	120V, 60Hz, 15Amps								

*Color(s) available: SS = Stainless steel, WW = White on white, CC = Bisque on bisque, BB = Black on black.

ALL MODELS AVAILABLE IN U.S. AND CANADA.

Bottom-Freezer Refrigerators

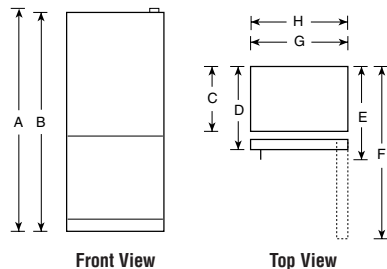

Total volume and shelf area are calculated by the Association of Home Appliance Manufacturers' standards.



Listed by Underwriters Laboratories

GE Bottom-Freezer Refrigerators

	GE				
	GDS18SCR	GDS18LCR	GDS18SBR	GDS18LBR	GBS18HBR
Stainless steel model	●		●		
Capacity					
Total (cu. ft.)	18.1	18.1	18.1	18.1	18.1
Fresh food (cu. ft.)	13.44	13.44	13.44	13.44	13.44
Freezer (cu. ft.)	4.64	4.64	4.64	4.64	4.64
Shelf area (sq. ft.)	21.0	21.0	21.0	21.0	22.2
Fresh Food Features					
Brita® Filtered Water Door Module	●	●	●	●	
Cabinet shelves	4 Glass	4 Glass	4 Glass	4 Glass	3 Glass
Adjustable	4 Split	4 Split	4 Split	4 Split	2 Split, 1 F/W
Slide-out	2	2	2	2	
Spillproof	4	4	4	4	
ShelfSaver rack	●	●	●	●	
Vegetable/fruit crisper(s)	2 Adj. Humidity	2 Adj. Humidity	2 Adj. Humidity	2 Adj. Humidity	2 Clear
Snack pan	Clear	Clear	Clear	Clear	Clear
Pan removal system	Slide over, slide out	Slide over, slide out	Slide over, slide out	Slide over, slide out	Slide over, slide out
Adjustable gallon door bins	3	3	3	3	
Snugger clip	●	●	●	●	
Fixed door bins	1 F/W w/ gallon storage	1 F/W w/ gallon storage	1 F/W w/ gallon storage	1 F/W w/ gallon storage	2 F/W w/ gallon storage
Dairy compartment	●	●	●	●	●
Interior light	Dual	Dual	Dual	Dual	Dual
Quiet Design	Deluxe	Deluxe	Deluxe	Deluxe	Deluxe
NeverClean condenser	●	●	●	●	●
2004 ENERGY STAR®	●	●	●	●	●
Freezer Features					
Factory-installed icemaker & bin	●	●	Opt. (IM4A)	Opt. (IM4A)	Opt. (IM4A)
Ice 'N Easy trays			2	2	2
Ice storage bin			●	●	●
Full slide-out wire basket(s)	1 F/W, 2 Split	1 F/W, 2 Split	1 F/W, 2 Split	1 F/W, 2 Split	1 F/W
Wire compartment shelves					1 F/W
Interior light	●	●	●	●	●
Exterior					
Color(s) available*	SS	WW, CC, BB	SS	WW, CC, BB	WW, CC, BB
Door handle(s)	SS Tubular	Color-Matched	SS Tubular	Color-Matched	Color-Matched
Exterior design	Rounded Doors	Rounded Doors	Rounded Doors	Rounded Doors	Rounded Doors
Door stops	●	●	●	●	●
Reversible doors		●		●	●
Choose left or right door opening	●		●		
Adjustable rollers	Front	Front	Front	Front	Front
Weights & Dimensions					
Height to top of hinge (in.) A	66-1/4	66-1/4	66-1/4	66-1/4	66-1/4
Height to top of case (in.) B	65-3/4	65-3/4	65-3/4	65-3/4	65-3/4
Case depth without door (in.) C	25-1/4	25-1/4	25-1/4	25-1/4	25-1/4
Case depth less door handle (in.) D	28	28	28	28	28
Case depth with door handle (in.) E	30-3/8	30-3/8	30-3/8	30-3/8	30-3/8
Depth w/fresh food door open 90° (in.) F	57-3/4	57-3/4	57-3/4	57-3/4	57-3/4
Width (in.) G	31	31	31	31	31
Width with door open 90° w/door handle (in.) H	33-1/2	33-5/8	33-1/2	33-5/8	33-5/8
Air clearances Each side (in.)	0	0	0	0	0
Top (in.)	1	1	1	1	1
Back (in.)	1/2	1/2	1/2	1/2	1/2
Approx. shipping weight (lbs.)	257	257	257	257	262
Power/Ratings	← 120V, 60Hz, 15Amps →				

*Color(s) available: SS = Stainless steel, WW = White on white, CC = Bisque on bisque, BB = Black on black.

ALL MODELS AVAILABLE IN U.S. AND CANADA.

Bottom-Freezer Refrigerators

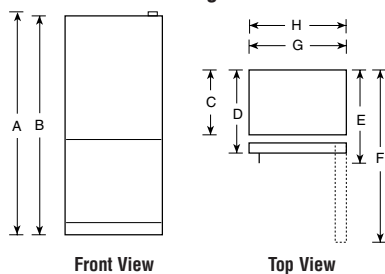

Total volume and shelf area are calculated by the Association of Home Appliance Manufacturers' standards.



Listed by Underwriters Laboratories

GE Profile CustomStyle™ Top-Freezer Refrigerators

	GE Profile™						
	PTC22MBM	PTC22MFM	PTC22SBM	PTC22SFM	PTI22MBM	PTI22MFM	PTI22SFM
Stainless steel model			●	●			●
Capacity							
Total (cu. ft.)	21.9	21.7	21.9	21.7	21.9	21.7	21.7
Fresh food (cu. ft.)	15.4	15.4	15.4	15.4	15.4	15.4	15.4
Freezer (cu. ft.)	6.5	6.3	6.5	6.3	6.5	6.3	6.3
Shelf area (sq. ft.)	22.4	20	22.4	20	22.4	20	20
Fresh Food Features							
SmartWater™ filtration system		●		●		●	●
LightTouch! dispenser		Crushed Ice, Cubes, Water		Crushed Ice, Cubes, Water		Crushed Ice, Cubes, Water	Crushed Ice, Cubes, Water
Upfront illuminated temperature controls	●	●	●	●	●	●	●
Cabinet shelves	4 Glass	4 Glass	4 Glass	4 Glass	4 Glass	4 Glass	4 Glass
Adjustable	4 Split	4 Split	4 Split	4 Split	4 Split	4 Split	4 Split
Slide-out, spillproof	3	3	3	3	3	3	3
Snugger™ clip	●	●	●	●	●	●	●
QuickSpace™ shelf	●	●	●	●	●	●	●
Meat pan	Adj. Temp.	Adj. Temp.	Adj. Temp.	Adj. Temp.	Adj. Temp.	Adj. Temp.	Adj. Temp.
Vegetable/fruit crisper(s)	2 Adj. Humidity	2 Adj. Humidity	2 Adj. Humidity	2 Adj. Humidity	2 Adj. Humidity	2 Adj. Humidity	2 Adj. Humidity
Slide-out, spillproof crisper cover	●	●	●	●	●	●	●
ClearLook™ adjustable gallon door bins	4	4	4	4	4	4	4
Fixed door bins	1 F/W tall bottle	1 F/W tall bottle	1 F/W tall bottle	1 F/W tall bottle	1 F/W tall bottle	1 F/W tall bottle	1 F/W tall bottle
Slide-out, slide-over pan removal system	●	●	●	●	●	●	●
Dairy compartment	●	●	●	●	●	●	●
Wine rack	●	●	●	●	●	●	●
Interior light system	Dual	Dual	Dual	Dual	Dual	Dual	Dual
Quiet Design	Deluxe	Deluxe	Deluxe	Deluxe	Deluxe	Deluxe	Deluxe
NeverClean™ condenser	●	●	●	●	●	●	●
Freezer Features							
Factory-installed icemaker & bin	Opt. (IM4A)	●	Opt. (IM4A)	●	Opt. (IM4A)	●	●
Ice 'N Easy trays	3		3		3		
Ice storage bin	●		●		●		
Wire compartment shelf(s)	2 Split (Adj.)	1 (Adj.)	2 Split (Adj.)	1 (Adj.)	2 Split (Adj.)	1 (Adj.)	1 (Adj.)
Door bins	2 Adj., 1 F/W fixed	2 fixed	2 Adj., 1 F/W fixed	2 fixed	2 Adj., 1 F/W fixed	2 fixed	2 fixed
Interior light	●	●	●	●	●	●	●
Exterior							
Color(s) available*	WW, BB	WW, CC, BB	BS	BS	WW, BB	WW, BB	BS
CustomStyle configuration	Trimless	Trimless	Trimless	Trimless	Installed Trim	Installed Trim	Installed Trim
Premium door handles*	CM Deluxe	CM Deluxe	Black Deluxe	Black Deluxe	CM Full-Length	CM Full-Length	Stainless Steel Appearance
Choose right or left door opening	●	●	●	●	●	●	●
Reversible doors	●						
Exterior design	Rounded Doors	Rounded Doors	Rounded Doors	Rounded Doors	Squared Doors	Squared Doors	Squared Doors
Adjustable rollers	All	All	All	All	All	All	All
Weights & Dimensions							
Height to top of hinge (in.) A	69-7/8	69-7/8	69-7/8	69-7/8	69-7/8	69-7/8	69-7/8
Height to top of case (in.) B	68-3/4	68-3/4	68-3/4	68-3/4	68-3/4	68-3/4	68-3/4
Height to top of door trim (in.)					70-1/2	70-1/2	70-1/2
Case depth without door (in.) C	23-3/4	23-3/4	23-3/4	23-3/4	23-3/4	23-3/4	23-3/4
Depth less door handle (in.) D	26-3/4	26-3/4	26-3/4	26-3/4	26-3/4	26-3/4	26-3/4
Depth with door handle (in.) E	28-5/8	28-5/8	28-5/8	28-5/8	28-3/8	28-3/8	28-5/8
Depth with fresh food door open 90° (in.) F							
Width (in.) G	35-3/4	35-3/4	35-3/4	35-3/4	35-3/4	35-3/4	35-3/4
Width with door open 90° w/door handle (in.) H	38-1/4	38-1/4	38-1/4	38-1/4	38	38	38
Air clearances Each side (in.)	1/8	1/8	1/8	1/8	1/8	1/8	1/8
Top (in.)	1	1	1	1	1	1	1
Back (in.)	1/2	1/2	1/2	1/2	1/2	1/2	1/2
Approx. shipping weight (lbs.)	300	324	300	324	300	324	360
Power/Ratings	← 120V, 60Hz, 15Amps →						
Accessories							
Black acrylic panels (optional)	N/A	N/A	N/A	N/A	PTPK22CBB	PTPK22DBB	N/A
White acrylic panels (optional)	N/A	N/A	N/A	N/A	PTPK22CWW	PTPK22DWW	N/A
Stainless steel panels (optional)	N/A	N/A	N/A	N/A	PTPK22CSS	PTPK22DSS	N/A
Black collar trim (optional)	N/A	N/A	N/A	N/A	TRMBISBB	TRMBISBB	N/A
White collar trim (optional)	N/A	N/A	N/A	N/A	TRMBISWW	TRMBISWW	N/A
Bisque collar trim (optional)	N/A	N/A	N/A	N/A	N/A	N/A	N/A
Stainless steel collar trim (optional)	N/A	N/A	N/A	N/A	TRMBISS	TRMBISS	TRMBISS

*Color(s) available: BS = Black case with stainless steel doors, WW = White on white, CC = Bisque on bisque, BB = Black on black, CM = Color-Matched.

ALL MODELS AVAILABLE IN U.S. AND CANADA.

Top-Freezer No-Frost Refrigerators

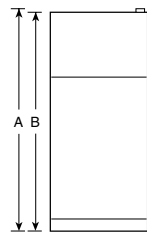

Front View

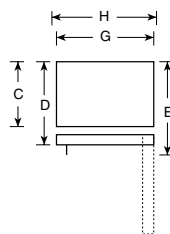

Top View



Total volume and shelf area are calculated by the Association of Home Appliance Manufacturers' standards.



Listed by Underwriters Laboratories

GE Profile CustomStyle™ Top-Freezer Refrigerators Installation Information & Specifications

Rough-In Dimensions

Standard, New Construction and Replacement Installation

Installation Tips to Maximize the Built-In Look

- All wall/floor molding should be removed prior to installation.
- Water recess on rear wall recommended to prevent water line damage. 48" minimum length, 1/4"-diameter water line tubing recommended.
- When possible, recess both copper water line and electrical outlet (see local codes).
- Front and rear leveling legs are adjustable for the built-in look (see owner's manual).

Collar Trim Installation

An enclosure is **required** to match up to the trim (see Typical Installation). To obtain the most integrated look, the cabinet or soffit above the refrigerator should extend out to the same depth as the side panels. The refrigerator opening must have minimum dimensions of 70-1/4" high x 36-1/8" wide x 24-1/2" deep as shown at right. If there is an overhead cabinet, allow 1" for cabinet door clearance with the top trim piece so the cabinet doors can be opened without hitting the top trim. If 1/2" side panels are used, then side trim and panel will be even. If 3/4" side panels are used, then some of the side panel will extend beyond the trim and must be finished.

Rough-In Dimensions

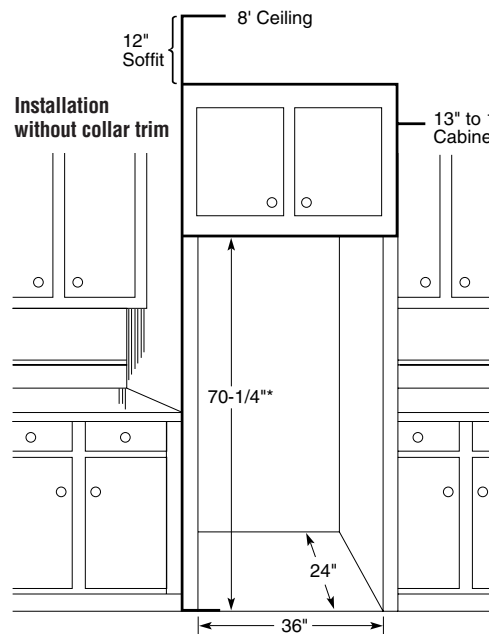

Collar Trim Installation

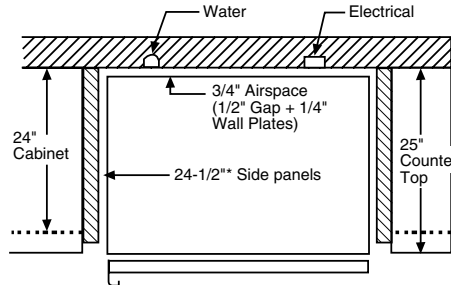
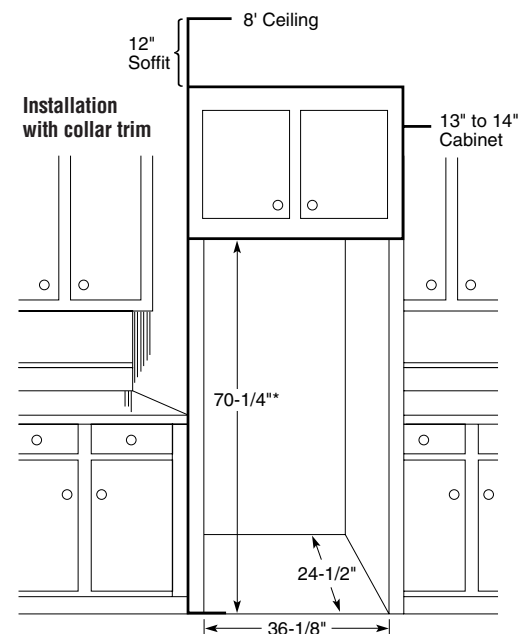

*The rough-in dimension of 70-1/4" is minimum and is measured from the finished floor to top of opening (or the underside of the overhead cabinets). For Models with Trim Kit: If frameless style cabinets are planned for above the refrigerator, you may need to consider adding a maximum of 1/4" (70-1/2") to height of opening to allow additional clearance between cabinet doors and top of refrigerator trim when cabinet doors are in open position.

For 22 cu. ft. models only.
*22" depth applies to the refrigerator opening, not the actual cabinet depth.

Door Panel Dimensions

Order your own custom wood panels to match cabinetry or other decor.

	Fresh Food Panels	Freezer Panel Without Dispenser	Freezer Panel With Dispenser
22 cu. ft.	B-42-1/4" C-35-3/4"	A-24-1/16" C-35-3/4"	D-24-1/16" C-35-3/4"

Panels up to 1/4" thick will fit door frame with no special preparation. Add filler behind material thinner than 1/4" for proper fit.
Note: Panels up to 3/4" will require special routing area around handles. Dimensions may vary depending on depth of panel.

Handle Side Clearance

- At least 2-5/8" (67mm) on the handle side for fingertip clearances.

Top and Bottom Clearance

- At least 3/16" (4.75mm) at the top and bottom edges to allow for trim flange.

Hinge Side Clearance

- A 3/4" (19mm) -thick door panel may strike the adjacent countertops when the door is fully opened. Therefore, the hinge side clearance to raised panel will vary according to the installation situation.
 - Allow 1-3/4" (44mm) clearance when installation does not include side panels.
 - The installation of 3/4" (19mm) -thick side panels requires less clearance because the space between the door and adjacent countertop is wider.
- To avoid door contact to countertop, consider:
 - Mitering the corner of the adjacent countertops 45°, or
 - Pulling the refrigerator forward enough to avoid contact.

Stability Leg

- The top-freezer refrigerator is the first cabinet-depth top-freezer. This means depth is more shallow than conventional models and the width is larger. The stability leg gives the unit extra support.

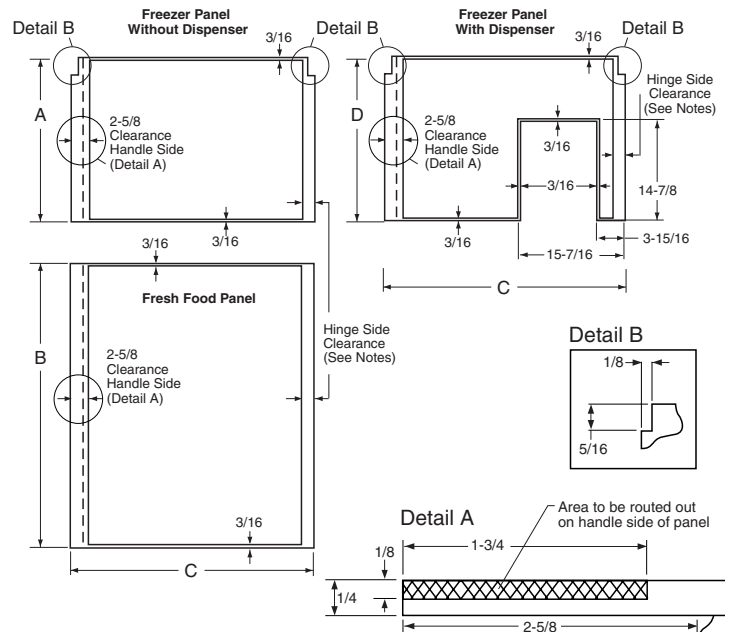

IMPORTANT: Before finalizing specifications for your GE Profile CustomStyle Refrigerator, please NOTE:
 • A minimum width of 36" is required for refrigerator installation
 • Be sure to allow for 1/2" or 3/4" side panels in addition to the 36" minimum

GE Profile Arctica® Top-Freezer Refrigerators

	GE Profile					
	PTS25SHR	PTS25LHR	PTS22SHR	PTS22LHR	PTS22SCR	PTS22LCR
Stainless steel model	●		●		●	
Capacity						
Total (cu. ft.)	24.6	24.6	21.7	21.7	21.7	21.7
Fresh food (cu. ft.)	17.51	17.51	15.35	15.35	15.35	15.35
Freezer (cu. ft.)	7.08	7.08	6.35	6.35	6.35	6.35
Shelf area (sq. ft.)	29.1	29.1	26.3	26.3	26.3	26.3
Fresh Food Features						
Internal water dispenser	●	●	●	●		
ClimateKeeper™ system	●	●	●	●	●	●
Multiflow air system	●	●	●	●	●	●
Upfront electronic touch temperature controls	●	●	●	●	●	●
Electronic sensors	●	●	●	●	●	●
GE SmartWater™ filtration	●	●	●	●		
Cabinet shelves	4 Glass	4 Glass	4 Glass	4 Glass	4 Glass	4 Glass
Adjustable	4 Split	4 Split	4 Split	4 Split	4 Split	4 Split
Slide-out, removable	3	3	3	3	3	3
Spillproof	4	4	4	4	4	4
ShelfSaver™ rack	●	●	●	●	●	●
Deli pan	Adj. Temp.	Adj. Temp.	Adj. Temp.	Adj. Temp.	Adj. Temp.	Adj. Temp.
Vegetable/fruit crisper(s)	2 Adj. Humidity	2 Adj. Humidity	2 Adj. Humidity	2 Adj. Humidity	2 Adj. Humidity	2 Adj. Humidity
Pivot-out pan removal system	●	●	●	●	●	●
ClearLock™ adjustable gallon door bins	4	4	4	4	4	4
Snugger™ clip(s)	2	2	2	2	2	2
Fixed door bins	1 (Tall Bottle)	1 (Tall Bottle)	1 (Tall Bottle)	1 (Tall Bottle)	1 (Tall Bottle)	1 (Tall Bottle)
Dairy compartment	●	●	●	●	●	●
Interior light system	Dual	Dual	Dual	Dual	Dual	Dual
Quiet Design	Premium	Premium	Premium	Premium	Premium	Premium
NeverClean™ condenser	●	●	●	●	●	●
2004 ENERGY STAR®	●	●	●	●	●	●
Freezer Features						
Factory-installed icemaker and bin	●	●	●	●	●	●
Multiflow air system (freezer)	●	●	●	●	●	●
FrostGuard™ technology	●	●	●	●	●	●
Spillproof freezer floor	●	●	●	●	●	●
Wire freezer compartment shelves	1 full-width (2 pos.)	1 full-width (2 pos.)	1 full-width (2 pos.)	1 full-width (2 pos.)	1 full-width (2 pos.)	1 full-width (2 pos.)
Freezer door bins	2 (1 Adj.)	2 (1 Adj.)	2 (1 Adj.)	2 (1 Adj.)	2 (1 Adj.)	2 (1 Adj.)
Tilt-out locking freezer door bin	●	●	●	●	●	●
Interior light	●	●	●	●	●	●
Exterior						
Color(s) available*	BS	WW, CC, BB	BS	WW, CC, BB	BS	WW, CC, BB
Deluxe door handle(s)	Black	Color-Matched	Black	Color-Matched	Black	Color-Matched
Customer installed handles	●	●	●	●	●	●
Exterior design	Rounded Doors	Rounded Doors	Rounded Doors	Rounded Doors	Rounded Doors	Rounded Doors
Reversible doors	●	●	●	●	●	●
Adjustable rollers	Front	Front	Front	Front	Front	Front
Weights & Dimensions						
Height to top of hinge (in.) A	68-5/8	68-5/8	67-1/2	67-1/2	67-1/2	67-1/2
Height to top of case (in.) B	67-7/8	67-7/8	66-7/8	66-7/8	66-7/8	66-7/8
Case depth without door (in.) C	27-5/8	27-5/8	27-5/8	27-5/8	27-5/8	27-5/8
Case depth less door handle (in.) D	31-5/8	31-5/8	31-5/8	31-5/8	31-5/8	31-5/8
Case depth with door handle (in.) E	33-5/8	33-5/8	33-5/8	33-5/8	33-5/8	33-5/8
Depth w/fresh food door open 90° (in.) F	66	66	63	63	63	63
Width (in.) G	35 7/8	35-7/8	32-7/8	32-7/8	32-7/8	32-7/8
Width w/door open 90° w/door handle (in.) H	38	38	35	35	35	35
Air clearances Each side (in.)	1/8	1/8	1/8	1/8	1/8	1/8
Top (in.)	1	1	1	1	1	1
Back (in.)	1	1	1	1	1	1
Approx. shipping weight (lbs.)	310	310	260	260	260	260
Power/Ratings	120V, 60Hz, 15Amps					

*Color(s) available: BS = Black case with stainless steel doors, WW = White on white, CC = Bisque on bisque, BB = Black on black.

ALL MODELS AVAILABLE IN U.S. AND CANADA.

Top-Freezer No-Frost Refrigerators

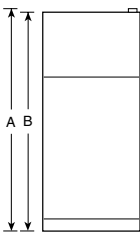

Front View

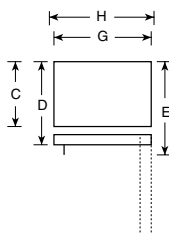

Top View



Total volume and shelf area are calculated by the Association of Home Appliance Manufacturers' standards.



Listed by Underwriters Laboratories

GE® Top-Freezer Refrigerators

	GE "K" Series						
	GTH22SBR GTH22SHR	GTS22KCP GTS22KHP	GTH22KBR GTS22KBP	GTH18KBR GTS18KBP	GTS18KCP GTS18KHP	GTS18SBP GTS18SHP	GTS16KBR
Capacity							
Total (cu. ft.)	21.7	21.7	21.7	17.9	17.9	17.9	15.8
Fresh food (cu. ft.)	15.35	15.35	15.35	12.87	12.87	12.87	11.69
Freezer (cu. ft.)	6.35	6.35	6.35	4.98	4.98	4.98	4.11
Shelf area (sq. ft.)	25.3	24.9	25.3	22.4	22.4	22.4	17.2
Fresh Food Features							
Upfront temperature controls	Illuminated	Illuminated	Illuminated	Illuminated	Illuminated	Illuminated	●
Cabinet shelves	4 Glass	4 Glass	4 Glass	4 Glass	4 Glass	4 Glass	4 Glass
Adjustable	4 Split	4 Split	4 Split	4 Split	4 Split	4 Split	4 Split
Spillproof	4	4	4	4	4	4	4
Internal water dispenser	- / ●	- / ●			- / ●	- / ●	
GE SmartWater filtration	- / ●	- / ●			- / ●	- / ●	
Vegetable/fruit crisper(s)	2 Adj. Humidity	2 Adj. Humidity	2 Adj. Humidity	2 Adj. Humidity	2 Adj. Humidity	2 Adj. Humidity	2 Adj. Humidity
Snack pan	●	●	●	●	●	●	●
Pivot-out pan removal system	●	●	●	Slide over, Slide out	Slide over, Slide out	Slide over, Slide out	
Adjustable gallon door bins	3	3	3	3	3	3	
Fixed door bins	1 (Tall Bottle)	1 (Tall Bottle)	1 (Tall Bottle)	1 (Tall Bottle)	1 (Tall Bottle)	1 (Tall Bottle)	2 F/W w/gallon storage
Dairy compartment	●	●	●	●	●	●	●
Interior light system	Dual	Dual	Dual	Dual	Dual	Dual	Single
Quiet Design	Deluxe	Deluxe	Deluxe	Deluxe	Deluxe	Deluxe	Deluxe
NeverClean condenser	●	●	●	●	●	●	●
ENERGY STAR®	●	●	● / -	● / -			●
Freezer Features							
Factory-installed icemaker and bin	Opt. (IM4A) / ●	●	Opt. (IM4A)	Opt. (IM4A)	●	Opt. (IM4A) / ●	Opt. (IM4A)
Ice 'N Easy trays	2 / -		2	2		2 / -	2
FrostGuard technology	●		● / -				
Spillproof freezer floor	●	●	●	●	●	●	●
Wire freezer compartment shelves	1 F/W (2 pos.)	1 F/W (2 pos.)	1 F/W (2 pos.)	Step	Step	Step	Step
Adjustable door bins	1	1	1				
Fixed door bins	1 Split (1 F/W)	1 Split (1 F/W)	1 Split (1 F/W)	2 Split (1 F/W)	2 Split (1 F/W)	2 Split (1 F/W)	2 Full-width
Interior light	●	●	●	●	●	●	●
Exterior							
Color(s) available*	BS	WW, CC, BB	WW / WW, CC, BB	WW, CC, BB	WW, CC, BB	BS	WW, CC
Door handle(s)*	Black	CM	CM	CM	CM	Black	CM
Customer installed handles	●	●	●	●	●	●	●
Exterior design	Rounded Doors	Rounded Doors	Rounded Doors	Rounded Doors	Rounded Doors	Square Doors	Square Doors
Reversible doors	●	●	●	●	●	●	●
Adjustable rollers	Front	Front	Front	Front	Front	Front	Front
Weights & Dimensions							
Height to top of hinge (in.) A	67-1/2	67-1/2	67-1/2	66-5/8	66-5/8	66-5/8	64-3/4
Height to top of case (in.) B	66-7/8	66-7/8	66-7/8	66-1/8	66-1/8	66-1/8	64-1/4
Height to mid-freezer (in.)	54-1/2	54-1/2	54-1/2	53-15/16	53-15/16	53-15/16	54-3/8
Case depth without door (in.) C	27-5/8	27-5/8	27-5/8	27-1/2	27-1/2	27-1/2	25-7/8
Case depth less door handle (in.) D	31-5/8	31-5/8	31-5/8	30-1/4	30-1/4	30-1/4	29-1/8
Case depth with door handle (in.) E	33-5/8	33-5/8	33-5/8	32-1/8	32-1/8	32-1/8	31
Depth w/fresh food door open 90° (in.) F	63	63	63	58-1/8	58-1/8	58-1/8	54-7/8
Width (in.) G	32-7/8	32-7/8	32-7/8	29-1/2	29-1/2	29-1/2	28
Width w/door open 90° w/door handle (in.) H	35	35	35	32	32	32	30-1/2
Air clearances Each side (in.)	1/8	1/8	1/8	1/8	1/8	1/8	1/8
Top (in.)	1	1	1	1	1	1	1
Back (in.)	1	1	1	1	1	1	1
Approx. shipping weight (lbs.)	255	260	255	231	231	231	166
Power/Ratings	120V, 60Hz, 15Amps						

*Color(s) available: BS = Black case with Stainless steel doors, WW = White on white, CC = Bisque on bisque, BB = Black on black, CM = Color-Matched.

ALL MODELS AVAILABLE IN U.S. AND CANADA.

Top-Freezer No-Frost Refrigerators

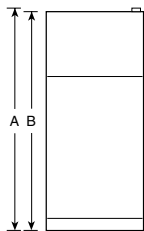

Front View

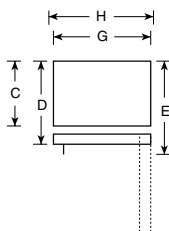

Top View

Note: All Top-Freezer No-Frost Right-Hand Refrigerator Doors: As you face the front of the refrigerator, the handle is on your left and the hinges are on your right.
 All Top-Freezer No-Frost Left-Hand Refrigerator Doors: As you face the front of the refrigerator, the handle is on your right and the hinges are on your left.



Total volume and shelf area are calculated by the Association of Home Appliance Manufacturers' standards.



Listed by Underwriters Laboratories

GE® Top-Freezer Refrigerators

	GE "J" Series					GE "H" Series	GE "G" Series	GE "F" Series	GE "E" Series
	GTL22JBP GTL22JCP	GTS22JBP GTS22JCP	GTL18JCP GTS18JCP	GTL18JBP GTH18JBR GTS18JBP	GTL16JBR GTS16JBR	GTS18HBR GTS18HCR	GTS18GBR GTS18GCR	GTS18FBR	GTS18EBR
Capacity									
Total (cu. ft.)	21.8	21.8	17.9	17.9	15.8	17.9	17.9	17.9	17.9
Fresh food (cu. ft.)	15.47	15.47	12.89	12.89	11.69	13.62	13.62	13.62	13.62
Freezer (cu. ft.)	6.37	6.37	5.03	5.03	4.11	4.26	4.26	4.26	4.26
Shelf area (sq. ft.)	25.4/25.1	25.4/25.1	22.2	22.6		22.2	22.2	22.2	22.2
Fresh Food Features									
Upfront temperature controls	Illuminated	Illuminated	Illuminated	Illuminated	●	●	●	●	●
Cabinet shelves	3 Glass	3 Glass	3 Glass	3 Glass	3 Glass	3 Glass	2 Glass	3 (1 F/W wire, 1 split wire, 1 split glass)	3 (1 F/W wire, 1 split wire, 1 split glass)
Adjustable	2 Split, 1 F/W	2 Split, 1 F/W	2 Split, 1 F/W	2 Split, 1 F/W	2 Split, 1 F/W	2 Split, 1 F/W	2 Full-width	3	3
Spillproof	●	●	●	●	●				
Vegetable/fruit crisper(s)	2 Clear	2 Clear	2 Clear	2 Clear	2 Adj, Humidity	2 Clear	2 Clear	2	2
Snack pan	Clear	Clear	Clear	Clear	Clear	Clear	Clear	●	●
Pivot-out pan removal system	●	●	Slide-out, Slide over	Slide-out, Slide over					
Fixed door bins	2 F/W, 1 w/gallon storage	2 F/W, 1 w/gallon storage	2 F/W, 1 w/gallon storage	2 F/W, 1 w/gallon storage					
Door shelves	1/2 w/gallon storage	1/2 w/gallon storage	1/2 w/gallon storage	1/2 w/gallon storage	2 F/W w/gallon storage	2 F/W w/gallon storage	2 F/W w/gallon storage	2 with gallon storage	2 with gallon storage
Dairy compartment	●	●	●	●	●	●	●	●	●
Interior light system	Dual	Dual	Dual	Dual	Single	Single	Single	Single	Single
Quiet Design	Deluxe	Deluxe	Deluxe	Deluxe	Deluxe	Deluxe	Deluxe	Deluxe	Deluxe
NeverClean™ condenser	●	●	●	●	●	●	●	●	●
ENERGY STAR®				- / ● / -					
Freezer Features									
Factory-installed icemaker & bin	Opt. (IM4A) / ●	Opt. (IM4A) / ●	●	Opt. (IM4A)	Opt. (IM4A)	Opt. (IM4A) / ●	Opt. (IM4A) / ●	Opt. (IM4A)	Opt. (IM4A)
Ice 'N Easy trays	2 / -	2 / -		2	2	2 / -	2 / -	2	2
Spillproof freezer floor	●	●	●	●					
Wire freezer compartment shelves	1 F/W (2 pos.)	1 F/W (2 pos.)	Step	Step	Step	Step	Step	Step	Step
Fixed door shelves	2 Full-width	2 Full-width	2 Full-width	2 Full-width	2 Full-width	2 Full-width	2 Full-width	2 Full-width	2 Full-width
Exterior									
Color(s) available*	CleanSteel™	WW, CC	CleanSteel WW, CC	CleanSteel WW, CC WW, CC	CleanSteel WW, BB, CC	WW, CC	WW, CC	WW, CC	WW, CC
Door handle(s)*	Black	CM	Black / CM	Black / CM / CM	Black / CM	CM	CM	CM	CM
Customer installed handles	●	●	●	●	●				
Exterior design	Rounded Doors	Rounded Doors	Rounded Doors	Rounded Doors	Square Doors	Square Doors	Square Doors	Square Doors	Square Doors
Reversible doors	●	●	●	●	●	●	●	●	●
Choose right or left door opening									
Adjustable rollers	Front	Front	Front	Front	Front	Front	Front	Front	Front
Weights & Dimensions									
Height to top of hinge (in.) A	67-1/2	67-1/2	66-5/8	66-5/8	64-3/4	67-3/8	67-3/8	67-3/8	67-3/8
Height to top of case (in.) B	66-7/8	66-7/8	66-1/8	66-1/8	64-1/4	66-7/8	66-7/8	66-7/8	66-7/8
Height to mid-freezer (in.)	54-1/2	54-1/2	53-15/16	53-15/16	54-3/8	57	57	57	57
Case depth without door (in.) C	27-5/8	27-5/8	27-1/2	27-1/2	25-7/8	26-3/4	26-3/4	26-3/4	26-3/4
Case depth less door handle (in.) D	31-5/8	31-5/8	30-1/4	30-1/4	29-1/8	30-1/2	30-1/2	30-1/2	30-1/2
Case depth with door handle (in.) E	33-5/8	33-5/8	32-1/8	32-1/8	31	32-3/8	32-3/8	32-3/8	32-3/8
Depth w/fresh food door open 90° (in.) F	63	63	58-1/8	58-1/8	54-7/8	56-3/8	56-3/8	56-3/8	56-3/8
Width (in.) G	32-7/8	32-7/8	29-1/2	29-1/2	28	28	28	28	28
Width w/door open 90° w/door handle (in.) H	35	35	32	32	30-1/2	30-3/4	30-3/4	30-3/4	30-3/4
Air clearances Each side (in.)	1/8	1/8	1/8	1/8	3/4	3/4	3/4	3/4	3/4
Top (in.)	1	1	1	1	1	1	1	1	1
Back (in.)	1	1	1	1	1	1	1	1	1
Approx. shipping weight (lbs.)	255/260	255/260	226	226	166	228	223	187	187
Power/Ratings	120V, 60Hz, 15Amps								

*Color(s) available: WW = White on white, CC = Bisque on bisque, BB = Black on black, CM = Color-Matched, CleanSteel™ = Stainless appearance.

ALL MODELS AVAILABLE IN U.S. AND CANADA.

Top-Freezer No-Frost Refrigerators

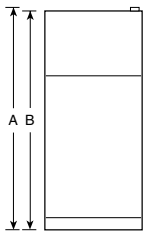

Front View

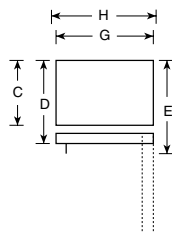

Top View

Note: All Top-Freezer No-Frost Right-Hand Refrigerator Doors: As you face the front of the refrigerator, the handle is on your left and the hinges are on your right.
All Top-Freezer No-Frost Left-Hand Refrigerator Doors: As you face the front of the refrigerator, the handle is on your right and the hinges are on your left.



Total volume and shelf area are calculated by the Association of Home Appliance Manufacturers' standards.



Listed by Underwriters Laboratories

GE Top-Freezer Refrigerators

	GE "B" Series							GE "A" Series	
	GTR18BBR	GTS17BBR GTS17BCR	GTR17BBR	GTS15BBR GTH15BBR	GTS15BCR	GTR15BBR	GTS12BBP	GTR18ABR GTS18ABR	GTR11AAP
Capacity									
Total (cu. ft.)	17.9	17.2	17.2	14.9	14.9	14.9	11.9	17.9	11.44
Fresh food (cu. ft.)	13.62	13.05	13.05	10.77	10.77	10.77	8.94	13.62	8.45
Freezer (cu. ft.)	4.01	3.86	3.86	3.86	3.86	3.86	2.95	4.26	2.99
Shelf area (sq. ft.)	18.0	17.5/16.7	17.5	17.2	16.4	17.2	12.1	16.9	13.4
Fresh Food Features									
Upfront temperature controls	●	●	●	●	●	●		●	
Cabinet shelves	2 Wire	2 Wire	2 Wire	2 Wire	2 Wire	2 Wire	2 Wire	3 Wire 2 Wire	2 Wire
Adjustable	2 F/W	2 F/W	2 F/W	2 F/W	2 F/W	2 F/W	2 F/W	3 F/W 2 F/W	2 F/W
Vegetable/fruit crisper(s)	2	2	2	2	2	2	1 F/W Divided	1 F/W	1 F/W
Door shelves	2 (Tall Bottle)	2 (Tall Bottle)	2 (Tall Bottle)	2 (Tall Bottle)	2 (Tall Bottle)	2 (Tall Bottle)	2-1/2 (1 Tall Bottle)	2 (Tall Bottle)	4 (1 Tall Bottle)
Dairy compartment	●	●	●	●	●	●	●		
Interior light system	Single	Single	Single	Single	Single	Single	Single	Single	Single
Quiet Design	Deluxe	Deluxe	Deluxe	Deluxe	Deluxe	Deluxe	Standard	Deluxe	Standard
NeverClean™ condenser	●	●	●	●	●	●		●	
ENERGY STAR®				- / ●					
Freezer Features									
Factory-installed icemaker & bin	Opt. (IM4A)	Opt. (IM4A) / ●	Opt. (IM4A)	Opt. (IM4A)	●	Opt. (IM4A)	Opt. (IM4A)	Opt. (IM4A)	
Ice 'N Easy trays	2	2 / -	2	2		2	1	2 / 1	2
Wire freezer compartment shelves									1 F/W
Fixed door shelves	2	2	2	2	2	2	2	2	2
Exterior									
Color(s) available*	WW, CC	WW, CC	WW, CC	WW, CC, BB WW, CC	WW, CC	WW, CC	WW, CC	WW	WW
Door handle(s)*	CM Recessed	CM	CM Recessed	CM	CM	CM Recessed	CM	CM Recessed CM	CM Recessed
Exterior design	Square Doors	Square Doors	Square Doors	Square Doors	Square Doors	Square Doors	Rounded Doors	Square Doors	Contoured Doors
Reversible doors	●	●	●	●	●	●	●	●	●
Choose right or left door opening		●	●	●	●	●	●	- / ●	
Adjustable rollers	Front	Front	Front	Front	Front	Front		Front	
Weights & Dimensions									
Height to top of hinge (in.) A	67-3/8	67-3/8	67-3/8	61-3/4	61-3/4	61-3/4	60-1/2	67-3/8	57-7/8
Height to top of case (in.) B	66-7/8	66-7/8	66-7/8	61-1/4	61-1/4	61-1/4	60	66-7/8	57-3/8
Height to mid-freezer (in.)	57	57	57	51-3/8	51-3/8	51-3/8	52	57	50
Case depth without door (in.) C	26-3/4	26-3/4	26-3/4	25-7/8	25-7/8	25-7/8	27-3/4	26-3/4	28-1/4
Case depth less door handle (in.) D	30-1/2	30	30	29-1/8	29-1/8	29-1/8	30-5/8	30-1/2	31-1/8
Case depth with door handle (in.) E	30-1/2	31-7/8	30	31	31	29-1/8	32-3/8	30-1/2 / 32-3/8	31-1/8
Depth w/fresh food door open 90° (in.) F	56-3/8	55-3/4	55-3/4	54-7/8	54-7/8	54-7/8	51-5/8	56-3/8	52-3/4
Width (in.) G	28	28	28	28	28	28	23-7/8	28	23-7/8
Width w/door open 90° w/door handle (in.) H	28-7/8	30-1/2	28-5/8	30-1/2	30-1/2	28-5/8	26-1/2	28-7/8 / 30-3/4	25-1/8
Air clearances Each side (in.)	3/4	3/4	3/4	3/4	3/4	3/4	1	3/4	1
Top (in.)	1	1	1	1	1	1	4	1	4
Back (in.)	1	1	1	1	1	1	2	1	3
Approx. shipping weight (lbs.)	178	179 / 184	178	166	171	165	170	178 / 177	163
Power/Ratings	120V, 60Hz, 15Amps								

*Color(s) available: WW = White on white, CC = Bisque on bisque, BB = Black on black, CM = Color-Matched.

ALL MODELS AVAILABLE IN U.S. AND CANADA.

Top-Freezer No-Frost Refrigerators

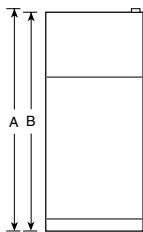

Front View

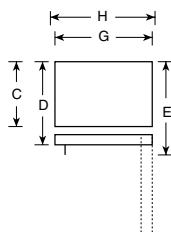

Top View

Note: All Top-Freezer No-Frost Right-Hand Refrigerator Doors: As you face the front of the refrigerator, the handle is on your left and the hinges are on your right.
All Top-Freezer No-Frost Left-Hand Refrigerator Doors: As you face the front of the refrigerator, the handle is on your right and the hinges are on your left.



Total volume and shelf area are calculated by the Association of Home Appliance Manufacturers' standards.



Listed by Underwriters Laboratories

GE® Manual Defrost Refrigerator

GE	
GMS10AAM	
Capacity	
Total (cu. ft.)	9.7
Fresh food (cu. ft.)	8.74
Freezer (cu. ft.)	.97*
Shelf area (sq. ft.)	9.88
Features	
Ice 'N Easy trays	2
Freezer chiller tray with baffle	●
Cabinet shelves	2 Adj.
Vegetable/fruit crisper	1 F/W
Door shelves	5 (2 Egg w/Pockets)
Tall bottle storage on door	●
Dairy compartment(s)	1
Freezer compartment shelf(s)	1 F/W
Economical/Quiet	
Cabinet/door insulation	Foam
Cabinet/door liner	Plastic
Appearance	
Color(s) available	White
Door handle(s)	Black
Right or left door opening	●
Weights & Dimensions	
Height to top of hinge (in.) A	58
Height to top of case (in.) B	57-9/16
Case depth without door (in.) C	21-3/8
Case depth with door less handle (in.) D	23-1/2
Case depth with door handle (in.) E	24-13/16
Depth with door open 90° less door handle (in.) F	44-13/16
Width (in.) G	23
Width w/door open 90° less door handle (in.) H	23-1/2
Air clearances	Each side (in.)
	Top (in.)
	Back (in.)
Approx. shipping weight (lbs.)	135

Manual Defrost Single-Door Refrigerator

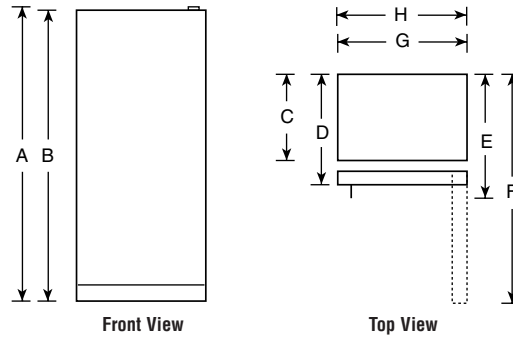

*Compartment for short-term storage of frozen food. The frozen food compartment of this refrigerator will make ice, and pre-frozen foods can be stored for about **two weeks**. It will not effectively freeze fresh foods or provide long-term storage for meats, poultry, or fish.

GE Spacemaker® Compact Refrigerators

	GE		
	GMR06AAP	GMR04AAM	GMR02BAN
Capacity			
Total (cu. ft.)	6.0	4.3	1.7
Fresh food (cu. ft.)	5.51	3.26	1.49
Freezer (cu. ft.)	.49**	.42**	.16**
Shelf area (sq. ft.)	8.8	6.0	2.9
Features			
Ice 'N Easy trays	2 Mini	1 Mini	1 Mini
Manual defrost	●	●	●
Cabinet shelves (wire)	2 (1 Adj.)	2	1
Can rack	●	●	●
Door shelves	1 F/W, 2 half-width	2 F/W, 1 half-width	1 F/W, 1 half-width
Interior light	●	●	●
Economical/Quiet			
Cabinet/door insulation	Foam	Polystyrene	Foam
Cabinet/door liner	HIPS	ABS	ABS
Appearance			
Color(s) available*	WW, BB	WW, BB	WW, BB
Door handles	White Visor/Black Visor	Color-Matched Recessed	Color-Matched Recessed
Rounded doors	●	●	●
Reversible doors	●	●	●
Weights & Dimensions			
Height (in.) A	34-1/4	32-1/8	18-15/16
Width (in.) B	23-5/8	20-1/16	17-1/2
Depth with handle (in.) C	25-7/8	21-7/8	19-1/4
Depth with door open 90° (in.) D	47-1/2	39-1/4	35-1/2
Air clearances	Each side (in.)		
	Top (in.)	0†	1/2
	Back (in.)	0	2
Approx. shipping weight (lbs.)	88	77	51
Accessories			
Custom trim (optional)	TPK6 (black only)		

*Color(s) available: WW = White on white, BB = Black on black.
 Compartment for short-term storage of frozen food. The frozen food compartment of this refrigerator will make ice, and pre-frozen foods can be stored for about **two weeks. It will not effectively freeze fresh foods or provide long-term storage for meats, poultry, or fish.
 † If installed against a wall, allow 1-1/4" on hinge side to allow for proper door opening.

GE Profile™ Wine Cooler

	GE Profile	
	PWR04FANBS	
Capacity		
Total (cu. ft.)	4.3	
Bottle capacity	29	
Features		
Electronic touch controls	●	
Adjustable temperature control (45-65°F)	●	
See-through door	●	
Door design	Contoured	
Pull-out and adjustable racks	Chrome wine rack	
Multiple shelf liner positions	5 full-width, 1 display	
Interior light	●	
Interior light timer (60 min. delay)	●	
Lock	●	
Appearance		
Color(s) available	Black case and Stainless trim	
Door handle	Recessed	
Free-standing	●	
Meets California Energy Commission (CEC) requirements	●	
Cabinet liner color	Black	
Reversible door	●	
Weights & Dimensions		
Height (in.) A	33-1/2	
Width (in.) B	20-1/8	
Depth with handle (in.) C	22-3/4	
Depth with door open 90° (in.) D	TBD	
Air clearances	Each side (in.)	1-1/2
	Top (in.)	2
	Back (in.)	2
Approx. shipping weight (lbs.)	97	

Spacemaker Compact Refrigerators/ Wine Coolers

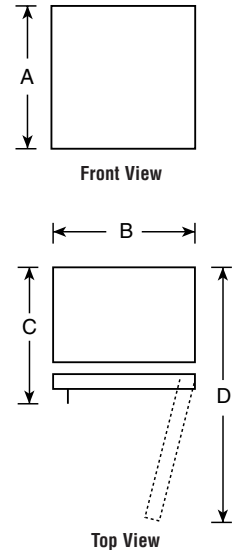

GE Chest Freezers

	GE							
	FCM25RM	FCM20DP	FCM15DP	FCM15SP	FCM9DM	FCM7DN	FCM5DM	FCM5SM
Capacity								
Total volume (cu. ft.)	25.1	19.7	14.8	14.8	8.8	7.0	5.0	5.0
Features								
Manual defrost	●	●	●	●	●	●	●	●
Temperature control	Adj.	Adj.	Adj.	Adj.	Adj.	Adj.	Adj.	Adj.
Power "ON" light	●	●	●	●	●	●	●	●
Wraparound condenser	●	●	●	●	●	●	●	●
Wraparound evaporator	●	●	●	●	●	●	●	●
Limited food loss warranty*	●	●	●	●	●	●	●	●
Upfront defrost water drain	●	●	●	●	●	●	●	●
Interior light	●	●	●	●	●	●	●	●
Lock	●	●	●	●	●	●	●	●
Lift-out and sliding bulk storage basket(s)	4	3	2	1	2	2	2	1
Economical/Quiet								
Insulation (cabinet and lid)-Foam	●	●	●	●	●	●	●	●
Cabinet liner	Steel Epoxy-Coated	Steel Epoxy-Coated	Steel Epoxy-Coated	Steel Epoxy-Coated	Steel Epoxy-Coated	Textured Aluminum	Textured Aluminum	Textured Aluminum
Appearance								
Color available	White	White	White	White	White	White	White	White
Handle	●	Recessed	Recessed	Recessed	●	Recessed	Recessed	Recessed
Textured steel case and lid	●	●	●	●	●	●	●	●
Weights & Dimensions								
Height (in.) A	35	35	35	35	34-1/4	33-1/8	33	33
Width (in.) B	73-7/8	61-1/4	48	48	41	38	29-1/8	29-1/8
Depth (in.) C	28-3/4	29-1/2	29-1/2	29-1/2	23-1/4	22-3/8	22-3/16	22-3/16
Height with lid open (in.) D	59-3/4	60-3/4	60-3/4	60-3/4	54-1/4	53-1/4	53-3/16	53-3/16
Air clearances Each side (in.)	3	3	3	3	3	3	3	3
Back (in.)	3	3	3	3	3	3	3	3
Approx. shipping weight (lbs.)	245	195	161	161	127	126	101	101

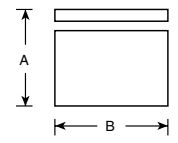

Front View

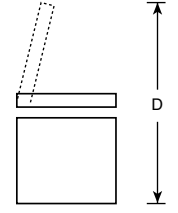

Side View

*See written warranty for complete details.

GE Upright Freezers

	GE							
	Frost-Free			Manual Defrost				
	FUF20DP	FUF17DP	FUF14DP	FUM21DP	FUM17DP	FUM14DP	FUM14SM	FUM5SN
Capacity								
Total volume (cu. ft.)	20.3	16.7	13.7	20.6	17.1	14.1	14.1	5.0
Shelf area (sq. ft.)	23.9	18.4	14.3	25.3	19.1	17.9	15.0	6.0
Features								
Temperature control	Adj.	Adj.	Adj.	Adj.	Adj.	Adj.	Adj.	Adj.
Limited food loss warranty*	●	●	●	●	●	●	●	●
Door shelves (total)	6	5	5	6	5	5	5	3
Defrost water drain	●	●	●	●	●	●	●	●
Interior light	●	●	●	●	●	●	●	●
Lock	●	●	●	●	●	●	●	●
Cabinet shelves (total)	5 (3 Adj.)	4 (3 Adj.)	3 (2 Adj.)	5 (1 Adj.)	4 (1 Adj.)	4 (1 Adj.)	3	2
Slide-out bulk storage basket	1	1	1	1	1	1	1	1
Economical/Quiet								
Defrost	Frost-Free	Frost-Free	Frost-Free	Manual	Manual	Manual	Manual	Manual
Magnetic door gasket	●	●	●	●	●	●	●	●
Cabinet liner	Baked enamel-on-steel	Baked enamel-on-steel	Baked enamel-on-steel	Baked enamel-on-steel	Baked enamel-on-steel	Baked enamel-on-steel	Baked enamel-on-steel	Polystyrene
Wraparound condenser	●	●	●	●	●	●	●	●
Appearance								
Color available	White	White	White	White	White	White	White	White
Door handle	Recessed	Recessed	Recessed	Recessed	Recessed	Recessed	Recessed	Recessed
Textured steel case/door	●	●	●	●	●	●	●	●
Weights & Dimensions								
Height (in.) A	70	64-1/2	59	70	64-1/2	59	59	33-1/2
Width (in.) B	32	32	28	32	32	28	28	21-3/8
Depth (in.) C	28-1/2	26-1/2	28-1/2	28-1/2	26-1/2	28-1/2	28-1/2	26-1/8
Depth with door open 90° (in.) D	59-1/8	57-1/8	55-1/8	59-1/8	57-1/8	55-1/8	55-1/8	45-3/4
Air clearances Each side (in.)	3	3	3	3	3	3	3	1
Top (in.)	3	3	3	3	3	3	3	4
Back (in.)	3	3	3	3	3	3	3	4
Approx. shipping weight (lbs.)	235	213	186	224	200	177	177	80

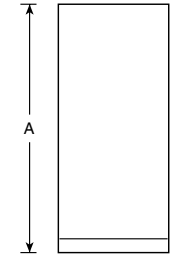

Front View

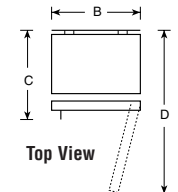

Top View

*See written warranty for complete details.

Answers that click!

GE puts everything you need at your fingertips.

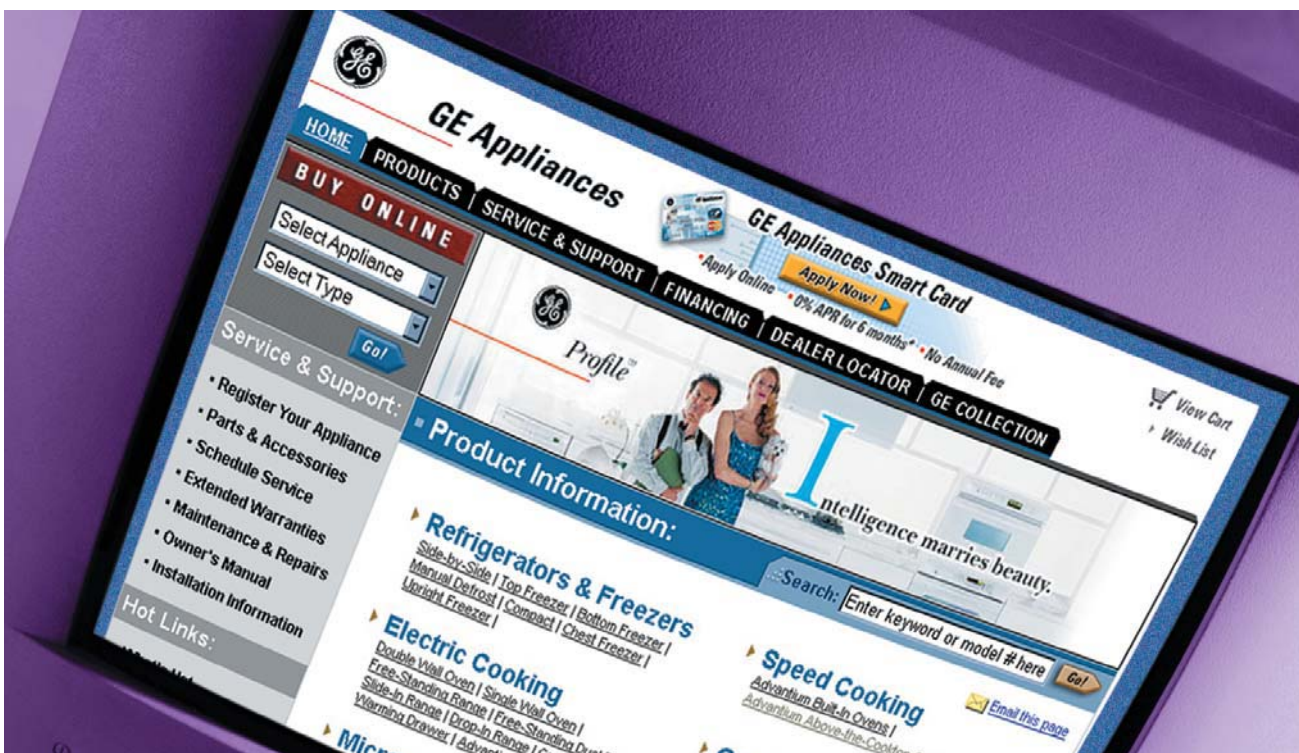

GE Appliances web site — 16 million visitors a year!
Visit us at GEAppliances.com

Everything you need to know about GE products is here. Access up-to-date information, find out “what’s new,” obtain dimensions, get installation tips and more. Extremely user-friendly, this one-stop site lets you research by brand, category or model number and even buy online through a local GE dealer.

GE Answer Center® saves you time. 800.626.2000

This 24-hour-a-day, 7-day-a-week service provides answers on product features, installation, service and more.



A Century of Quality and Innovation

For more than a century, GE has been committed to producing innovative products that change the way people live. The result of thorough research and rigorous testing, GE appliances are designed for years of dependable performance. Today, the GE tradition of quality and innovation continues.



GE Appliances

GE Consumer & Industrial
GE Company
Louisville, Kentucky 40225
GEAppliances.com

Before purchasing an appliance, read important information about its estimated annual energy consumption or energy efficiency rating that is available from your retailer or GEAppliances.com

GE has a policy of continuous improvement of its products and reserves the right to change materials and specifications without notice.

© 2004 GE Company
Pub. No. 2-S154 PC37392