



# planning guide

Featuring GE Profile™ and GE®  
36" and 30" telescopic downdraft systems



imagination at work

# 36" and 30" cooktop/downdraft system counter installation

## JVB98SH/94SH, JVB67H/37H

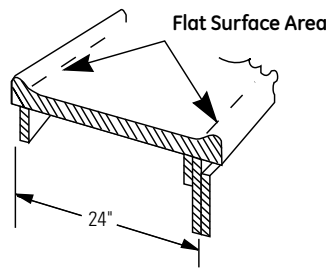
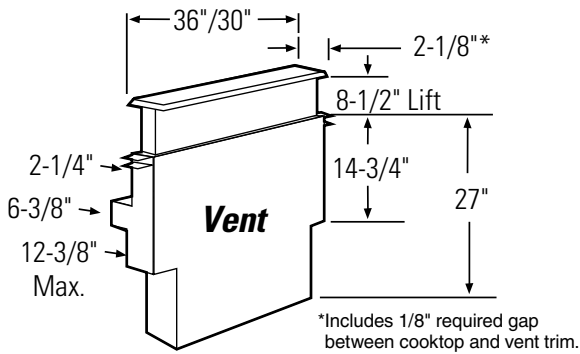

**Note:** The countertop must be at least 26" deep with a flat surface area of 23-1/2" or more, front to back. In addition, other clearances to the front edge must be considered.

**Note:** JP950S, JP940S, JP930S, JP910S, JGP940S require 23-5/8" flat surface area.

**Note:** See specific cutout illustrations with your cooktop model to determine requirements.

**Note:** A countertop with a raised or a rolled front edge may not allow enough flat area for installation.

	Planning Installation			Preparing Cutout		
	"A" Fig. 1	"B" Fig. 1	"B" & Vent Fig. 1	"C" Fig. 2	"D" Fig. 2	
	Cooktop Overall Width	Cooktop Overall Depth	Overall Surface Depth Cooktop Depth + Vent Cover Depth	Min. required setback from front edge to front edge of cutout	Countertop inside cabinet clearance	
<b>36" Models</b>						
<b>Electric</b>						
JP980S/JP960S/JP970S	36-1/8"	21-1/4"	25 -1/4"	2-1/2"*	22-11/16"	
JP980/JP960/JP970	36"	21-3/16"	24-5/8"	2-1/2"*	22-11/16"	
JP655S	36-1/8"	20-7/16"				
JP655	36"	20-3/8"				
JP626	35-1/2"	21"	25-1/4"	2-1/2"	22-11/16"	
<b>Gas</b>						
JGP975/JGP963/ JGP637/JGP630/JGP628	36"	21"	25-1/4"	2-1/2"	22-11/16"	
JGP970S	36"	21-1/4"	24-11/16"	2-1/2"*	22-11/16"	
JGP970	36"	21-3/16"	24-11/16"	2-1/2"*	22-11/16"	
<b>30" Models</b>						
<b>Electric</b>						
JP950S/JP940S/ JP930S/JP910S	29-7/8"	21-1/2"	25-3/4"	2-1/2"*	22-7/16"	
JP950/JP940/ JP930/JP910	29-3/4"	21-7/16"	25-1/8"	2-1/2"*	22-7/16"	
JP355	29-3/4"	20-7/8"	25-1/2"	2-1/2"	22-7/16"	
JP340	29-3/4"	20-7/8"	25-1/2"	2-1/2"	22-7/16"	
<b>Gas</b>						
JGP933/JGP337/ JGP330/JGP328	30"	21"	25-1/4"	2-1/2"	22-7/16"	
JGP940S	29-3/4"	21-3/8"	25-1/4"	2-1/2"*	22-7/16"	
JGP940	29-3/4"	21-7/16"	25-1/4"	2-1/2"*	22-7/16"	
JGP321	30-1/4"	21-1/4"	25-1/2"	3-1/4"	22-7/16"	

\*Raised edge bull nose countertops may require up to 3/8" additional clearance to prevent interference with curved front.

**Required to maintain U.L. or AGA approvals.**

**Fig. 1**  
Overall cooktop dimensions

Note: Minimum flat surface required is "B" + vent cover depth.

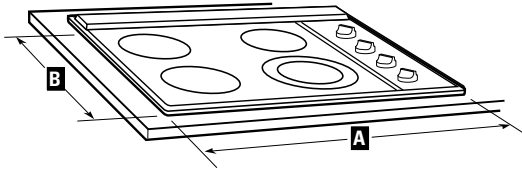

**Fig. 2**  
Cutout dimensions

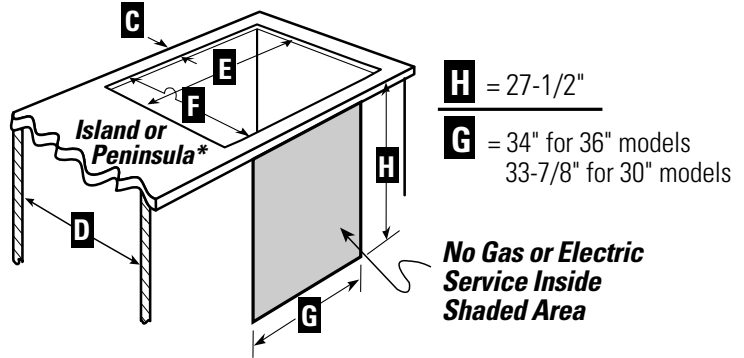

\*These vents are recommended for island installation. Against the wall installations are limited due to dimension requirements. Refer to installation instructions, packed with product, for further details.

	"E" Fig. 2 Combined Cutout Width	"F" Fig. 2 Combined Cutout Depth
	33-7/8"	21-7/8"
	33-7/8"	21-3/4"
	33-7/8"	21-7/8"
	33-7/8"	21-7/8"
	33-7/8"	21-3/4"
	33-7/8"	21-3/4"
	28-1/2"	22-3/8"
	28-1/2"	22-1/4"
	28-1/2"	22-3/8"
	28-1/2"	22-3/8"
	28-1/2"	22-3/8"
	28-1/2"	22-3/8"
	28-1/2"	22-1/4"
	28-1/2"	22-1/4"
	28-1/2"	22-1/4"

**Fig. 3**  
Venting island to outside wall

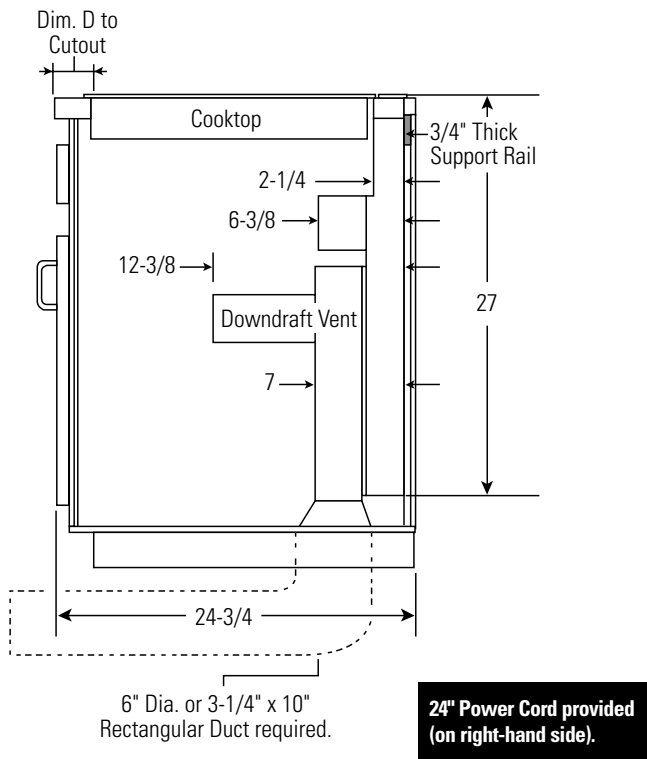

It is recommended that gas and/or electrical service for cooktop and downdraft should not be placed on the back wall because it may interfere with the downdraft plenum.

## Quality features

	JVB98SH	JVB94SH	JVB67HWW JVB67HCC JVB67HBB	JVB37HWW JVB37HCC JVB37HBB
<b>Features</b>				
Upfront variable-speed fan w/slide control	●	●	●	●
Separate remote raise/lower switch	●		●	
Blower rating (CFM)	500	500	500	500
Optional blower mount capabilities	●	●	●	●
3-1/4" x 10" rectangular duct	●	●	●	●
Minimum 6" round duct capability	●	●	●	●
Removable grease filters	●	●	●	●
<b>Appearance</b>				
Color appearance*	SS	SS	WW CC BB	WW BB BB
Cover plate	SS	SS	White Bisque Black	White Bisque Black
Telescopic snorkel assembly	Black	Black	Black	Black
<b>Weights &amp; Dimensions</b>				
Width (in inches)	36	30	36	30
Approx. shipping weight (lbs.)	76	72	76	72
<b>Power/Ratings</b>				
Current rating amps @ 120V	4.0	4.0	4.0	4.0

\*SS = Stainless steel, WW = White on white, CC = Bisque on bisque, BB = Black on black.













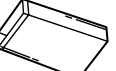

The downdraft cooktop ventilation is ideal for island or peninsula installations. The downdraft vent retracts when not in use.

- Vents smoke and vapors
- Quiet, powerful 500-CFM performance

**Note:** Approved for use with all GE electric and sealed burner gas cooktops, **not approved for standard burner gas cooktops.**

**Installation information:** Before installing, consult installation instructions packed with product for current dimensional data.

## Ducting information

Duct pieces	Equivalent length*	Duct Pieces	Equivalent length*	Duct pieces	Equivalent length*
 6" Round Straight	1 ft. (per foot length)	 3-1/4" x 10" 45° Elbow	5 ft.	 3-1/4" x 10" to 6" Round Transition 90° Elbow	12 ft.
 3-1/4" x 10" Straight	1 ft. (per foot length)	 3-1/4" x 10" 90° Flat Elbow	24 ft.	 6" Round Wall Cap with Damper	21 ft.
 6" 90° Elbow	15 ft.	 6" Round to 3-1/4" x 10" Transition	7 ft.	 3-1/4" x 10" Wall Cap with Damper	27 ft.
 6" 45° Elbow	9 ft.	 3-1/4" x 10" to 6" Round Transition	5 ft.	 6" Round Roof Cap	20 ft.
 3-1/4" x 10" 90° Elbow	16 ft.	 6" Round to 3-1/4" x 10" Transition 90° Elbow	20 ft.	 6" Round Roof Vent	24 ft.

### Should not exceed 150 equivalent ft.

\*Equivalent lengths of duct pieces are based on actual tests conducted by GE Evaluation Engineering and reflect requirements for good venting performance with any downdraft cooktop, with a downdraft rated at 500-CFM.

## Warranty information

**Full one-year warranty** (parts and labor at no additional charge). See written warranty for details.

Before purchasing an appliance, read important information about its estimated annual energy consumption or energy efficiency rating that is available from your retailer or ge.com

GE has a policy of continuous improvement of its products and reserves the right to change materials and specifications without notice.

**GE Answer Center® saves you time. 800.626.2000**  
This 24-hour-a-day, 7-day-a-week service provides answers on product features, installation, service and more.



**GE Consumer & Industrial**  
Appliances  
General Electric Company  
Louisville, KY 40225  
ge.com

GE has a policy of continuous improvement of its products and reserves the right to change materials and specifications without notice.

© 2005 GE Company  
Pub. No. 3-X085 PC40691