

OTR24XU



Product family	Microwave oven
Category	Built-in
Power source	AC
Cooking Method	Microwave
Oven controls	Electronic

Controls



Display	1 LED	Opening	Side opening
Controls	Touch controls		

Options



Timer	Electronic	Turntable stop option	Yes
End-of-cooking acoustic alarm	Yes	Quick-start option	Yes
Child safety lock	Yes		

Technical Features



Cavity material	Galvanized steel	Total no. of door glasses	1
No. of lights	1	Security Thermostat	Yes
Lighting	LED	Microwave door protection screen	Yes
Turntable	Yes	Microwave stops when door is opened	Yes
Turntable dimensions	34.5 "	Inner cavity dimensions (HxWxD)	272x388x391 mm
Light on when door is open	Yes	Microwave effective power	1000 W

Accessories Included

Glass tray

Glass tray

Electrical Connection

Current
Voltage





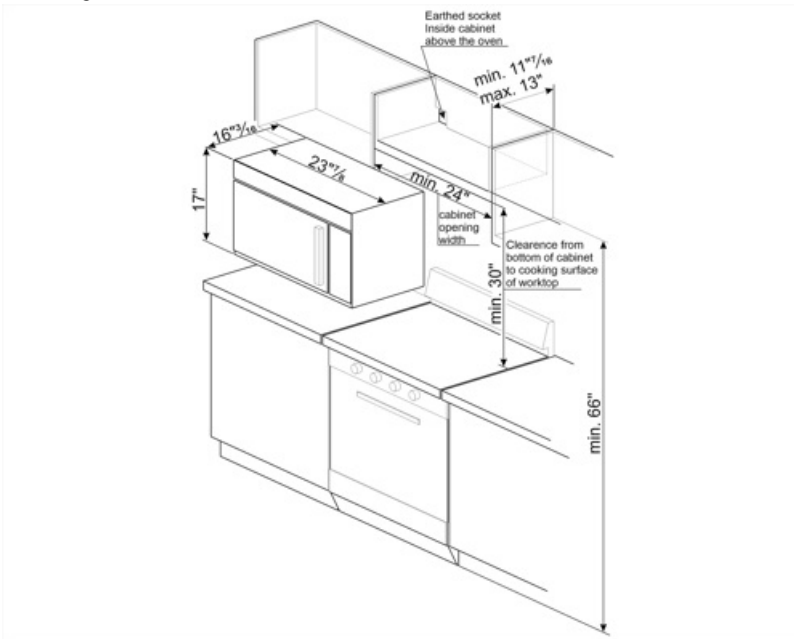

15 A
120 V

Frequency
Power cord length

60 Hz
39 3/8 "



Symbols glossary

- | | | | |
|--|--|---|---|
|  | Child lock: some models are fitted with a device to lock the programme/cycle so it cannot be accidentally changed. |  | Microwave energy shortens cooking times dramatically and produces energy savings. |
|  | Defrost by time: with this function the time of thawing of foods are determined automatically. |  | Defrost by weight: With this function the defrosting time is determined |
|  | Microwave: Penetrating straight into the food, microwaves cook very quickly and with considerable energy savings. Suitable for cooking without fat, they are also able to thaw and heat food without altering its original appearance and aroma. The microwave function can also be combined with conventional functions with all the resulting advantages. Ideal for all types of food. |  | Side lights: Two opposing side lights increase visibility inside the oven. |
|  | Touch controls: Easy to use touch controls allow the appliance to be programmed at the touch of a button. | | |

Benefit (TT)

Electronic control

Timely temperature management and heat uniformity

Touch control

Easy operation of the display and cooking by touch

Child control lock

Thanks to the child safety lock, the microwave provides peace of mind for parents while improving overall safety in the home environment

Quick start

One-touch cooking and heating start-up with the Quick Start option for a simple and intuitive user experience